

SF1140B

75.00 MHz
SAW Filter

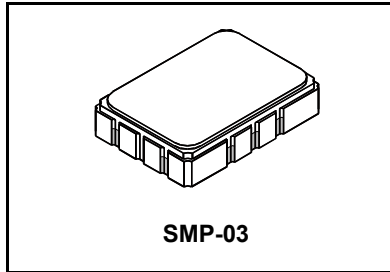

- **Designed for SDARS IF Receiver**
- **Low Insertion Loss**
- **5.0 X 7.0 mm Surface-Mount Case**
- **Differential Input and Output**
- **Complies with Directive 2002/95/EC (RoHS)**
- **Moisture Sensitivity Level: 1**
- **AEC-Q200 Qualified**

Absolute Maximum Ratings

Rating	Value	Units
Maximum Incident Power in Passband	+10	dBm
Max. DC voltage between any 2 terminals	30	VDC
Storage Temperature Range	-40 to +85	°C
Max Soldering Profile	265°C for 10 s	

Characteristic	Sym	Notes	Min	Typ	Max	Units
Nominal Center Frequency	f_c		75.000			MHz
Passband	Insertion Loss at f_c	IL		11.0	13.0	dB
		1dB Passband	BW_1	± 2.1	± 2.7	MHz
	Fast Amplitude Ripple over $f_c \pm 2.1$ MHz				1.0	dB _{P-P}
	Group Delay Variation over $f_c \pm 2.1$ MHz	GDV		40	200	ns _{P-P}
Rejection	fc-15 to fc-7.15 and fc+15 to fc+65 MHz		40	43		dB
		fc+7.15 to fc+15 MHz	36			
Operating Temperature Range	T_A		-40		+85	°C
Differential Input and Output Impedance	250 ohms					
Case Style	SMP-03 7 x 5 mm Nominal Footprint					
Lid Symbolization (YY=year, WW=week, S=shift, ##= Sequence Code)	RFM SF1140B <u>YYWWS##</u>					

Electrical Connections

Connection	Terminals
Port 1 Hot	10
Port 1 Ground Return	1
Port 2 Hot	5
Port 2 Ground Return	6
Case Ground	All Others

 **CAUTION: Electrostatic Sensitive Device. Observe precautions for handling.**

NOTES:

1. The design, manufacturing process, and specifications of this device are subject to change.
2. US or International patents may apply.
3. RoHS compliant from the first date of manufacture.

NOTES:

REV	EDN	DESCRIPTION	DATE
A	9214	INITIAL RELEASE	29nov00
B	10655	REVISED	30apr02
C	11078	REVISED	20nov02

- 1 ~~SOLDER "TAPE" 4 PLACES ONTO COMPONENT SIDE OF PCB AS SHOWN.~~
- 2 USE A WRIST STRAP WHEN SOLDERING TRANS 1, AND TRANS 2 TO PCB. (CUT LEADS .07 IN.)
- 3 MOUNT AND SOLDER ALL COMPONENTS ON PCB.
- 4 CUT CENTER CONDUCTORS FROM J1 AND J2 TO .10 IN.
- 5 MOUNT J1 AND J2 AS SHOWN (SOLDER BACKSIDE ALSO).
- 6 LABEL DEMO BOARD ACCORDINGLY.
- 7 MOUNT "FILTER" ON TOPSIDE OF PCB AS SHOWN.
8. ~~MOUNT L1 AND L2 90° TO EACH OTHER.~~
9. ~~CUT SHIELD IN TWO PIECES, "SHIELD A" AND "SHIELD B", SOLDER TO PCB AS SHOWN.~~

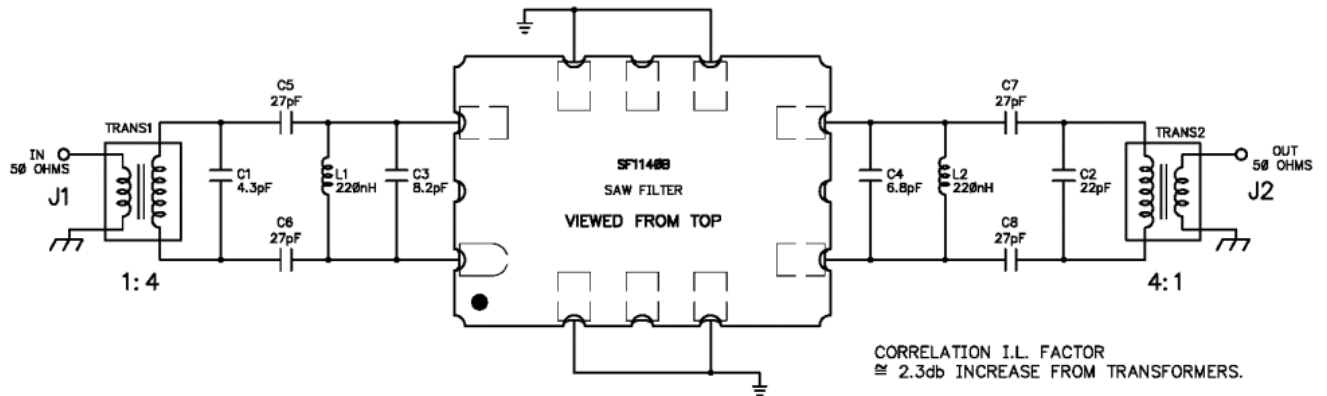

TITLE				
ASSY DIAGRAM, SF1140B-DEMO, S, TD				
SIZE	FSCM NO.	DWG. NO.	REV	SHEET
B	2U874	SF1140B-100	C	1/2

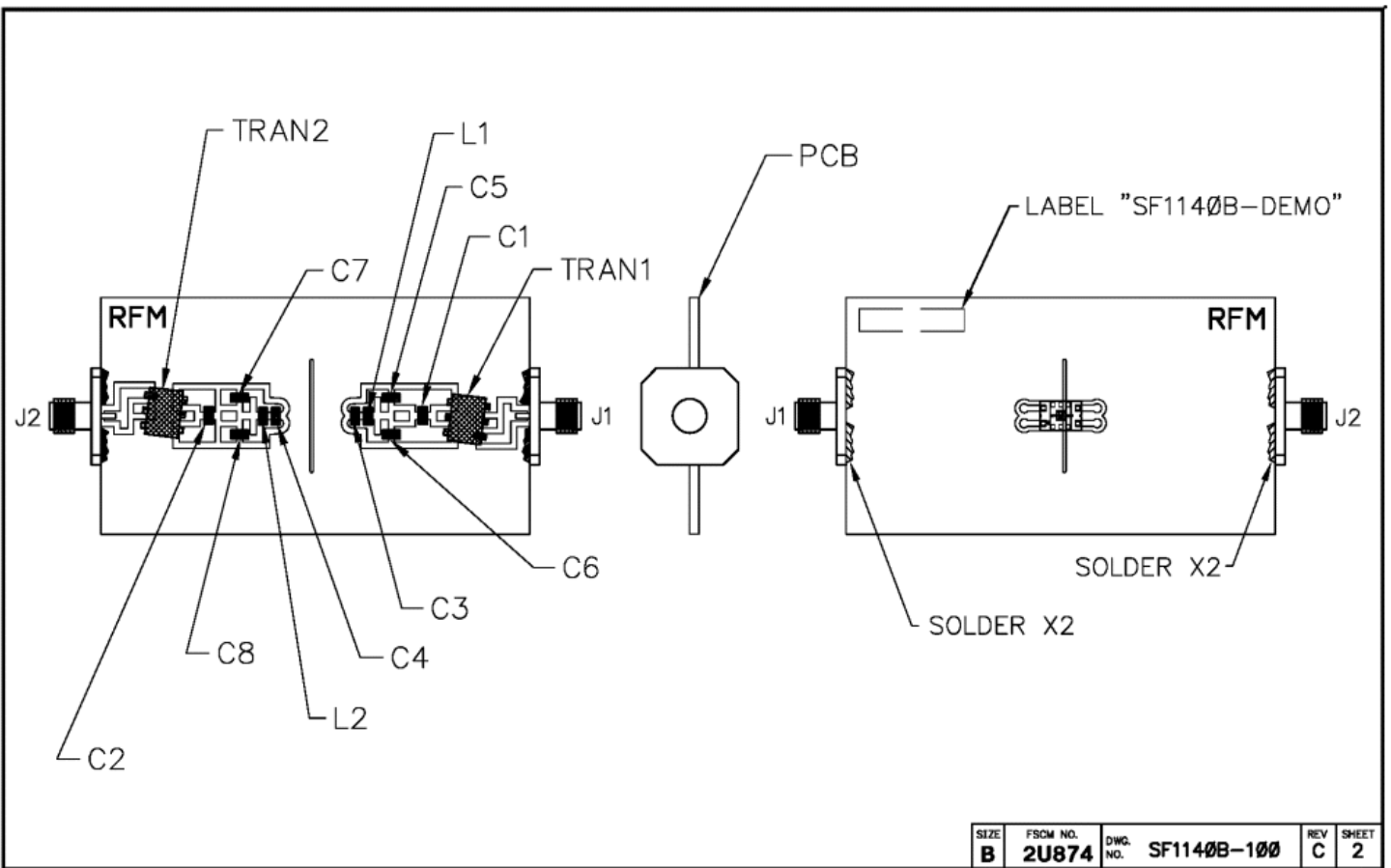

SIZE	FSCM NO.	DWG. NO.	REV	SHEET
B	2U874	SF1140B-100	C	2

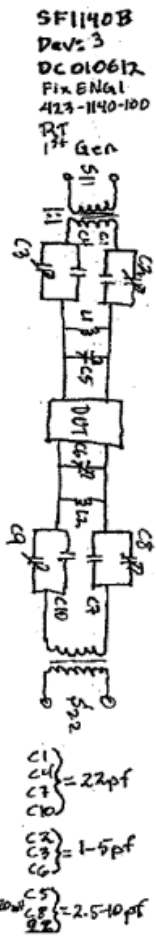
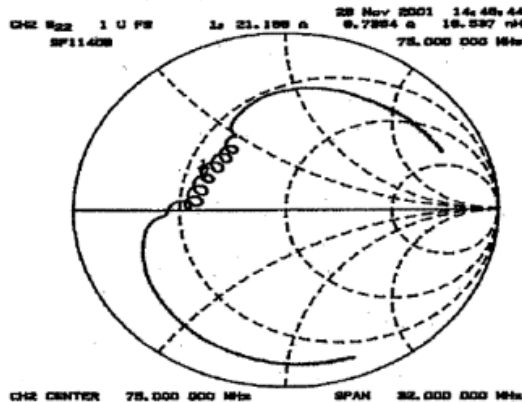
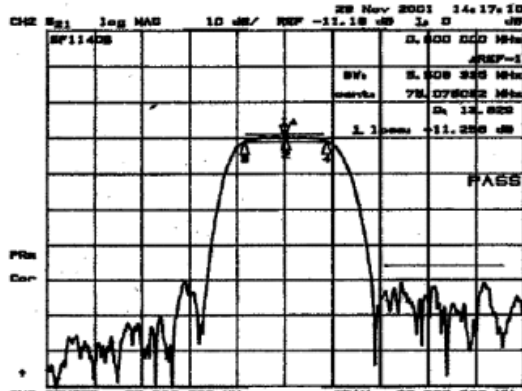
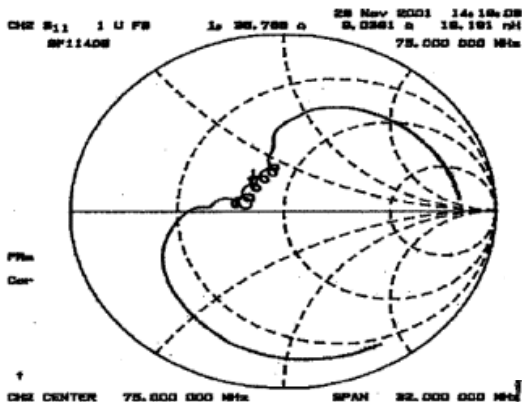
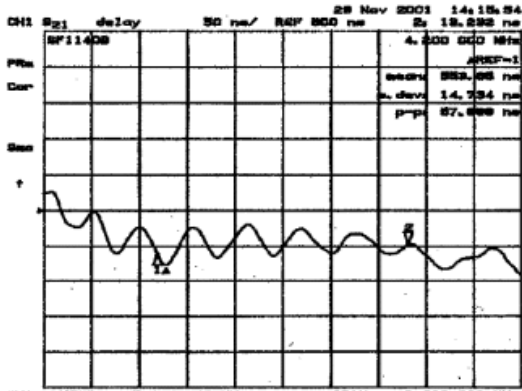

SIZE	A	FSM NO.	2U874	DWG NO.	432-1140-113	REV	A
SCALE	NONE	EDN NO.	11078	SHEET	4	OF	4

Tape and Reel Specifications

Tape and Reel Standard per ANSI/EIA481

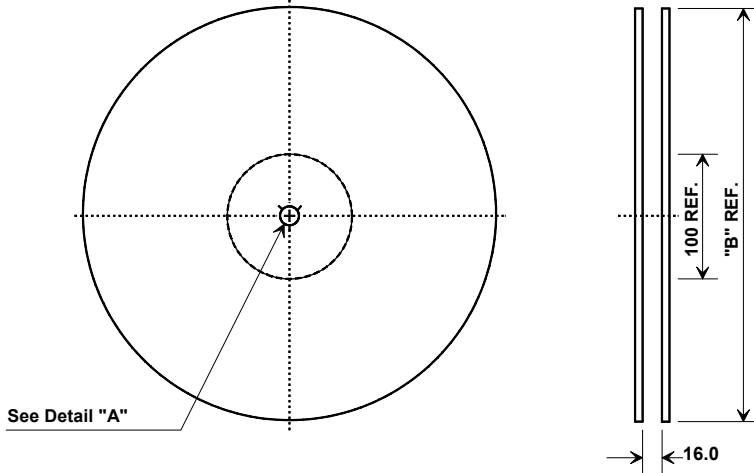

"B "		Quantity Per Reel
Nominal Size		
Inches	millimeters	
7	178	500
13	330	2000

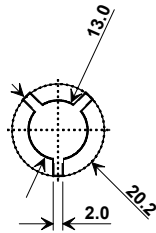

COMPONENT ORIENTATION and DIMENSIONS

Carrier Tape Dimensions		Tolerance
Ao	5.5 mm	± 0.1mm
Bo	7.5 mm	± 0.1mm
Ko	2.0 mm	± 0.1mm
Pitch	8.0 mm	± 0.1mm
W	16.0 mm	± 0.2mm

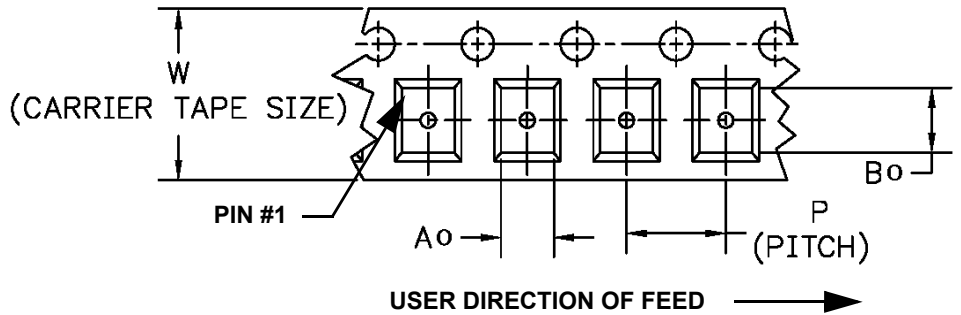
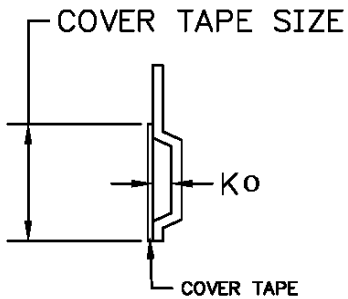

SMP-03 Case

10-Terminal Ceramic Surface-Mount Case

7 x 5 mm Nominal Footprint

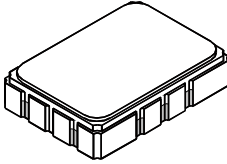

Recommended PCB Footprint

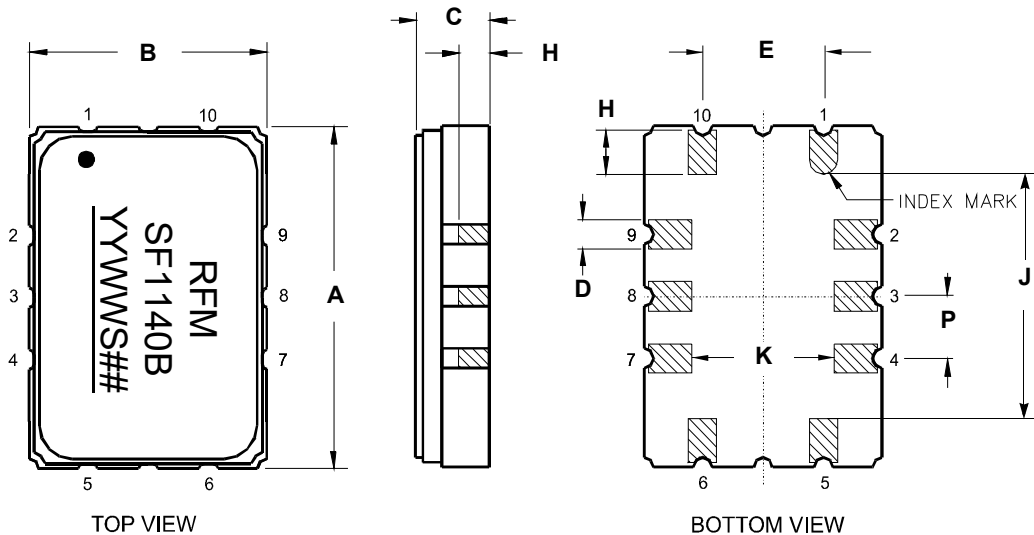
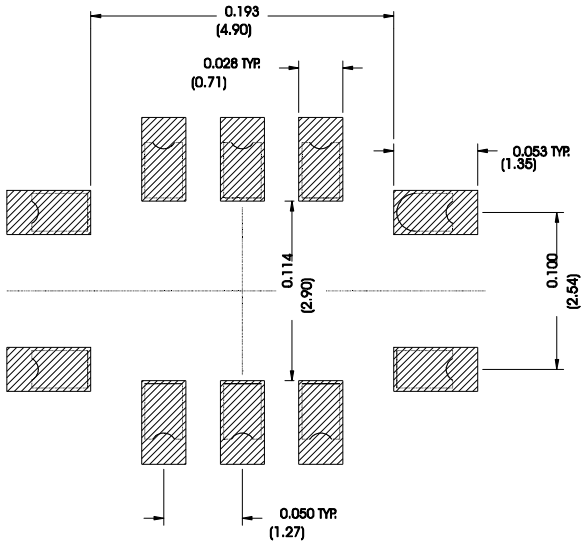

Case Dimensions						
Dimension	mm			Inches		
	Min	Nom	Max	Min	Nom	Max
A	6.80	7.00	7.20	0.268	0.276	0.283
B	4.80	5.00	5.20	0.189	0.197	0.205
C		1.65	2.00		0.065	0.079
D	.47	0.60	.73	0.019	0.024	0.029
E	2.41	2.54	2.67	0.095	0.100	0.105
H	0.87	1.0	1.13	0.034	0.039	0.044
J	4.87	5.00	5.13	0.192	0.197	0.202
K	2.87	3.00	3.13	0.113	0.118	0.123
P	1.14	1.27	1.40	0.045	0.050	0.055

Materials	
Solder Pad Termination	Au plating 30 - 60 ulnches (76.2-152 uM) over 80-200 ulnches (203-508 uM) Ni.
Lid	Fe-Ni-Co Alloy Electroless Nickel Plate (8-11% Phosphorus) 100-200 ulnches Thick
Body	Al ₂ O ₃ Ceramic

Electrical Connections		
Connection		Terminals
Port 1	Input or Return	10
	Return or Input	1
Port 2	Output or Return	5
	Return or Output	6
Ground		All others
Single Ended Operation		Return is ground
Differential Operation		Return is hot

Recommended Reflow Profile

1. Preheating shall be fixed at 150~180°C for 60~90 seconds.
2. Ascending time to preheating temperature 150°C shall be 30 seconds min.
3. Heating shall be fixed at 220°C for 50~80 seconds and at 260°C+0/-5°C peak (10 seconds).
4. Time: 5 times maximum.

