

SELF-OSCILLATING HALF-BRIDGE DRIVER

Features

- Integrated 600V half-bridge gate driver
- 15.6V zener clamp on V_{CC}
- True micropower start up
- Tighter initial deadtime control
- Low temperature coefficient deadtime
- Shutdown feature (1/6th V_{CC}) on C_T pin
- Increased undervoltage lockout Hysteresis (1V)
- Lower power level-shifting circuit
- Constant LO, HO pulse widths at startup
- Lower di/dt gate driver for better noise immunity
- Low side output in phase with RT
- Internal 50nsec (typ.) bootstrap diode (IR2153D)
- Excellent latch immunity on all inputs and outputs
- ESD protection on all leads
- Also available LEAD-FREE

Description

The IR2153D(S) are an improved version of the popular IR2155 and IR2151 gate driver ICs, and incorporates a high voltage half-bridge gate driver with a front end oscillator similar to the industry standard CMOS 555 timer. The IR2153 provides more functionality and is easier to use than previous ICs. A shutdown feature has been designed into the C_T pin, so that both gate driver outputs can be disabled using a low voltage control signal. In addition, the gate driver output pulse widths are the same once the rising undervoltage lockout threshold on V_{CC} has been reached, resulting in a more stable profile of frequency vs time at startup. Noise immunity has been improved significantly, both by lowering the peak di/dt of the gate drivers, and by increasing the undervoltage lockout hysteresis to 1V. Finally, special attention has been paid to maximizing the latch immunity of the device, and providing comprehensive ESD protection on all pins.

Product Summary

V _{OFFSET}	600V max.
Duty Cycle	50%
T _r /T _p	80/40ns
V _{clamp}	15.6V
Deadtime (typ.)	1.2 μs

Packages

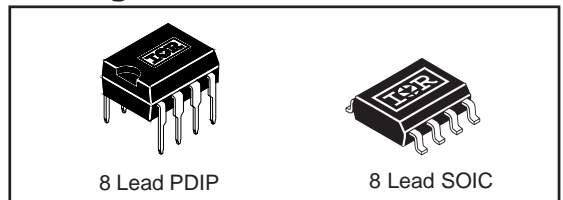

Typical Connections

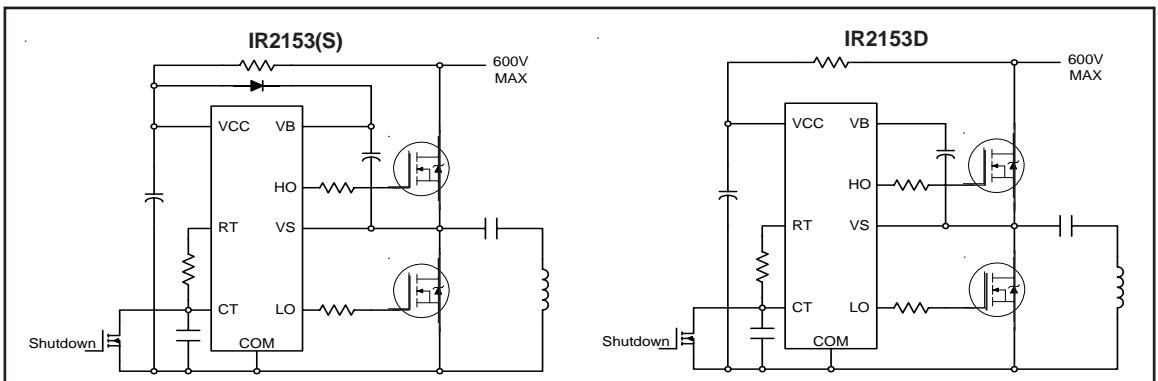

IR2153(D)(S) & (PbF)

NOTE: For new designs, we recommend IR's new product IRS2153D

Absolute Maximum Ratings

Absolute maximum ratings indicate sustained limits beyond which damage to the device may occur. All voltage parameters are absolute voltages referenced to COM, all currents are defined positive into any lead. The thermal resistance and power dissipation ratings are measured under board mounted and still air conditions.

Symbol	Definition	Min.	Max.	Units	
V_B	High side floating supply voltage	-0.3	625	V	
V_S	High side floating supply offset voltage	$V_B - 25$	$V_B + 0.3$		
V_{HO}	High side floating output voltage	$V_S - 0.3$	$V_B + 0.3$		
V_{LO}	Low side output voltage	-0.3	$V_{CC} + 0.3$		
V_{RT}	R_T pin voltage	-0.3	$V_{CC} + 0.3$		
V_{CT}	C_T pin voltage	-0.3	$V_{CC} + 0.3$		
I_{CC}	Supply current (note 1)	—	25	mA	
I_{RT}	R_T pin current	-5	5		
dV_S/dt	Allowable offset voltage slew rate	-50	50	V/ns	
P_D	Maximum power dissipation @ $T_A \leq +25^\circ\text{C}$	(8 Lead DIP)	—	1.0	W
		(8 Lead SOIC)	—	0.625	
R_{thJA}	Thermal resistance, junction to ambient	(8 Lead DIP)	—	125	$^\circ\text{C}/\text{W}$
		(8 Lead SOIC)	—	200	
T_J	Junction temperature	-55	150	$^\circ\text{C}$	
T_S	Storage temperature	-55	150		
T_L	Lead temperature (soldering, 10 seconds)	—	300		

Recommended Operating Conditions

For proper operation the device should be used within the recommended conditions.

Symbol	Definition	Min.	Max.	Units
V_{BS}	High side floating supply voltage	$V_{CC} - 0.7$	V_{CLAMP}	V
V_S	Steady state high side floating supply offset voltage	-3.0 (note 2)	600	
V_{CC}	Supply voltage	10	V_{CLAMP}	
I_{CC}	Supply current	(note 3)	5	mA
T_J	Junction temperature	-40	125	$^\circ\text{C}$

Note 1: This IC contains a zener clamp structure between the chip V_{CC} and COM which has a nominal breakdown voltage of 15.6V. Please note that this supply pin should not be driven by a DC, low impedance power source greater than the V_{CLAMP} specified in the Electrical Characteristics section.

Note 2: Care should be taken to avoid output switching conditions where the V_S node flies inductively below ground by more than 5V.

Note 3: Enough current should be supplied to the V_{CC} pin of the IC to keep the internal 15.6V zener diode clamping the voltage at this pin.

Recommended Component Values

Symbol	Component	Min.	Max.	Units
R_T	Timing resistor value	10	—	$k\Omega$
C_T	C_T pin capacitor value	330	—	μF

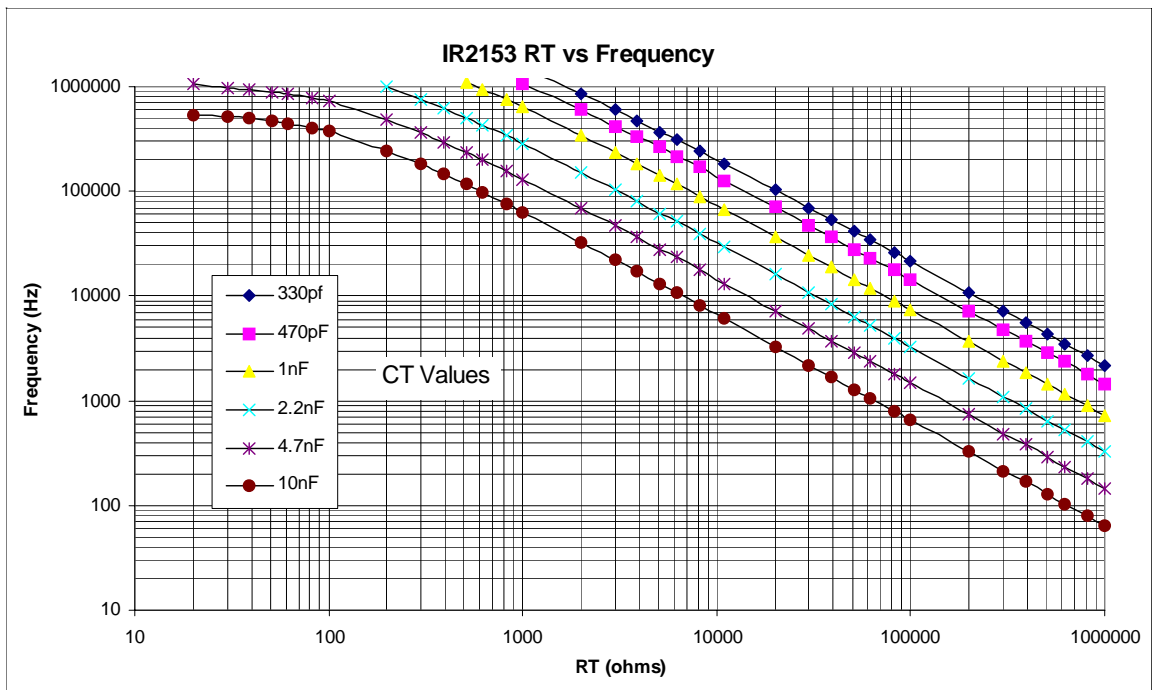

IR2153(D)(S) & (PbF)

NOTE: For new designs, we recommend IR's new product IRS2153D

Electrical Characteristics

V_{BIAS} (V_{CC} , V_{BS}) = 12V, C_L = 1000 pF, C_T = 1 nF and T_A = 25°C unless otherwise specified. The V_{IN} , V_{TH} and I_{IN} parameters are referenced to COM. The V_O and I_O parameters are referenced to COM and are applicable to the respective output leads: HO or LO.

Low Voltage Supply Characteristics						
Symbol	Definition	Min.	Typ.	Max.	Units	Test Conditions
V_{CCUV+}	Rising V_{CC} undervoltage lockout threshold	8.1	9.0	9.9	V	
V_{CCUV-}	Falling V_{CC} undervoltage lockout threshold	7.2	8.0	8.8		
V_{CCUVH}	V_{CC} undervoltage lockout Hysteresis	0.5	1.0	1.5		
I_{QCCUV}	Micropower startup V_{CC} supply current	—	75	150	μ A	$V_{CC} \leq V_{CCUV-}$
I_{QCC}	Quiescent V_{CC} supply current	—	500	950		
V_{CLAMP}	V_{CC} zener clamp voltage	14.4	15.6	16.8	V	$I_{CC} = 5mA$
Floating Supply Characteristics						
Symbol	Definition	Min.	Typ.	Max.	Units	Test Conditions
I_{QBSUV}	Micropower startup V_{BS} supply current	—	0	10	μ A	$V_{CC} \leq V_{CCUV-}$
I_{QBS}	Quiescent V_{BS} supply current	—	30	50		
V_{BSMIN}	Minimum required V_{BS} voltage for proper functionality from R_T to HO	—	4.0	5.0	V	$V_{CC} = V_{CCUV+} + 0.1V$
I_{LK}	Offset supply leakage current	—	—	50	μ A	$V_B = V_S = 600V$
V_F	Bootstrap diode forward voltage (IR2153D)	0.5	—	1.2	V	$I_F = 250mA$
Oscillator I/O Characteristics						
Symbol	Definition	Min.	Typ.	Max.	Units	Test Conditions
f_{osc}	Oscillator frequency	19.4	20	20.6	kHz	$R_T = 36.9k\Omega$
		94	100	106		$R_T = 7.43k\Omega$
d	R_T pin duty cycle	48	50	52	%	$f_o < 100kHz$
I_{CT}	C_T pin current	—	0.001	1.0	μ A	
I_{CTUV}	UV-mode C_T pin pulldown current	0.30	0.70	1.2	mA	$V_{CC} = 7V$
V_{CT+}	Upper C_T ramp voltage threshold	—	8.0	—	V	
V_{CT-}	Lower C_T ramp voltage threshold	—	4.0	—		
V_{CTSD}	C_T voltage shutdown threshold	1.8	2.1	2.4		
V_{RT+}	High-level R_T output voltage, $V_{CC} - V_{RT}$	—	10	50	mV	$I_{RT} = 100\mu A$
		—	100	300		$I_{RT} = 1mA$
V_{RT-}	Low-level R_T output voltage	—	10	50		$I_{RT} = 100\mu A$
		—	100	300		$I_{RT} = 1mA$
V_{RTUV}	UV-mode R_T output voltage	—	0	100		$V_{CC} \leq V_{CCUV-}$
V_{RTSD}	SD-Mode R_T output voltage, $V_{CC} - V_{RT}$	—	10	50		$I_{RT} = 100\mu A$, $V_{CT} = 0V$
		—	10	300		$I_{RT} = 1mA$, $V_{CT} = 0V$

Electrical Characteristics (cont.)

Gate Driver Output Characteristics						
Symbol	Definition	Min.	Typ.	Max.	Units	Test Conditions
V _{OH}	High level output voltage, V _{BIAS} - V _O	—	0	100	mV	I _O = 0A
V _{OL}	Low-level output voltage, V _O	—	0	100		I _O = 0A
V _{OL_UV}	UV-mode output voltage, V _O	—	0	100		I _O = 0A V _{CC} ≤ V _{CCUV} -
t _r	Output rise time	—	80	150	nsec	
t _f	Output fall time	—	45	100		
t _{sd}	Shutdown propagation delay	—	660	—		
t _d	Output deadtime (HO or LO)	0.75	1.20	1.65	μsec	

Lead Definitions

Symbol	Description
V _{CC}	Logic and internal gate drive supply voltage
R _T	Oscillator timing resistor input
C _T	Oscillator timing capacitor input
COM	IC power and signal ground
LO	Low side gate driver output
V _S	High voltage floating supply return
HO	High side gate driver output
V _B	High side gate driver floating supply

Lead Assignments

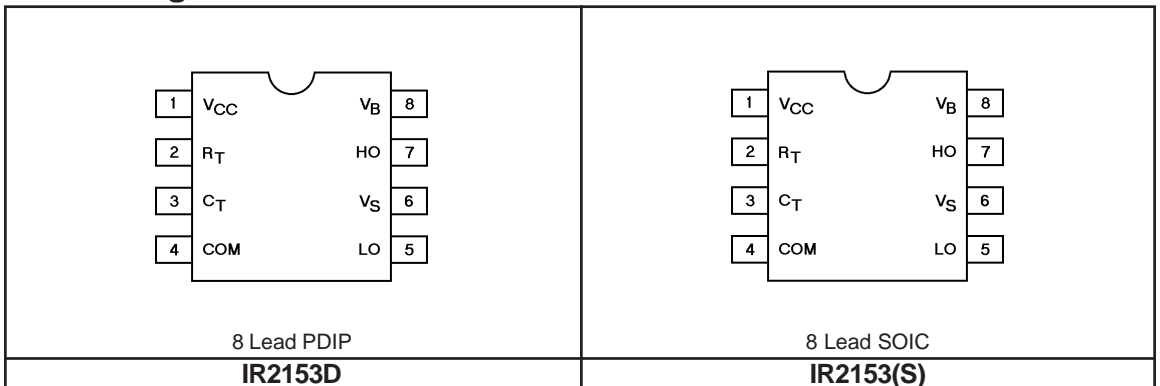

NOTE: The IR2153D is offered in 8 lead PDIP only.

IR2153(D)(S) & (PbF)

NOTE: For new designs, we recommend IR's new product IRS2153D

Functional Block Diagram for IR2153(S)

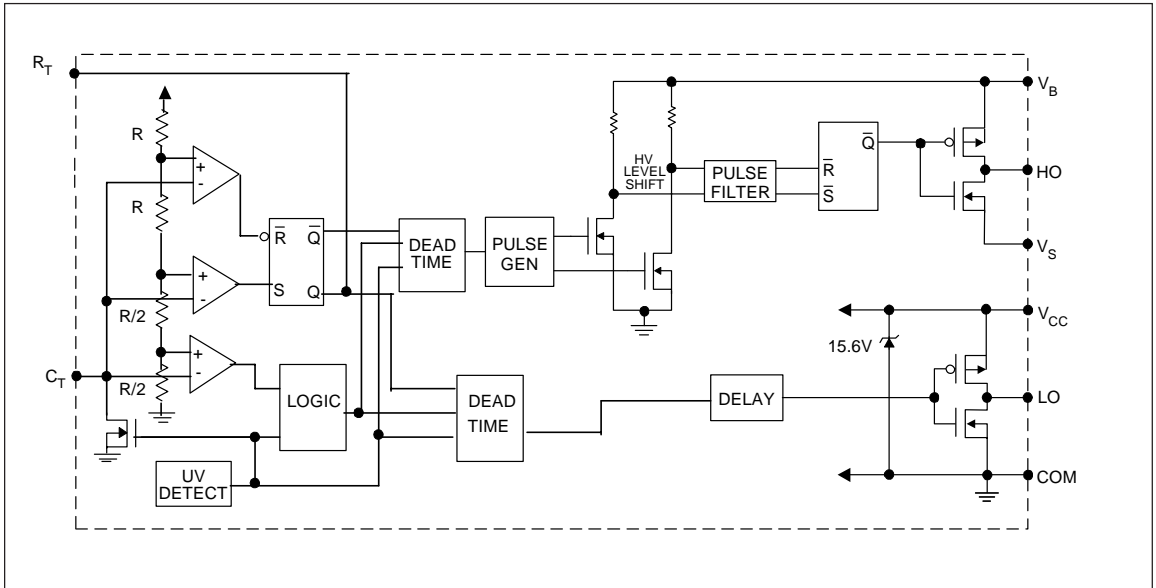

Functional Block Diagram for IR2153D

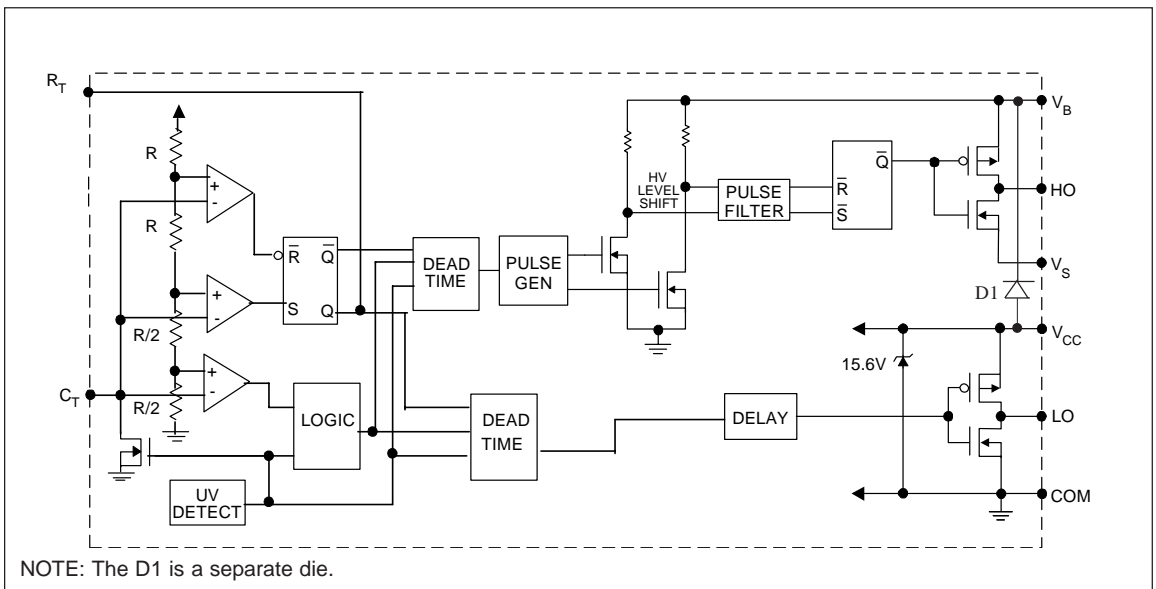

NOTE: The D1 is a separate die.

IR2153(D)(S) & (PbF)

NOTE: For new designs, we recommend IR's new product IRS2153D

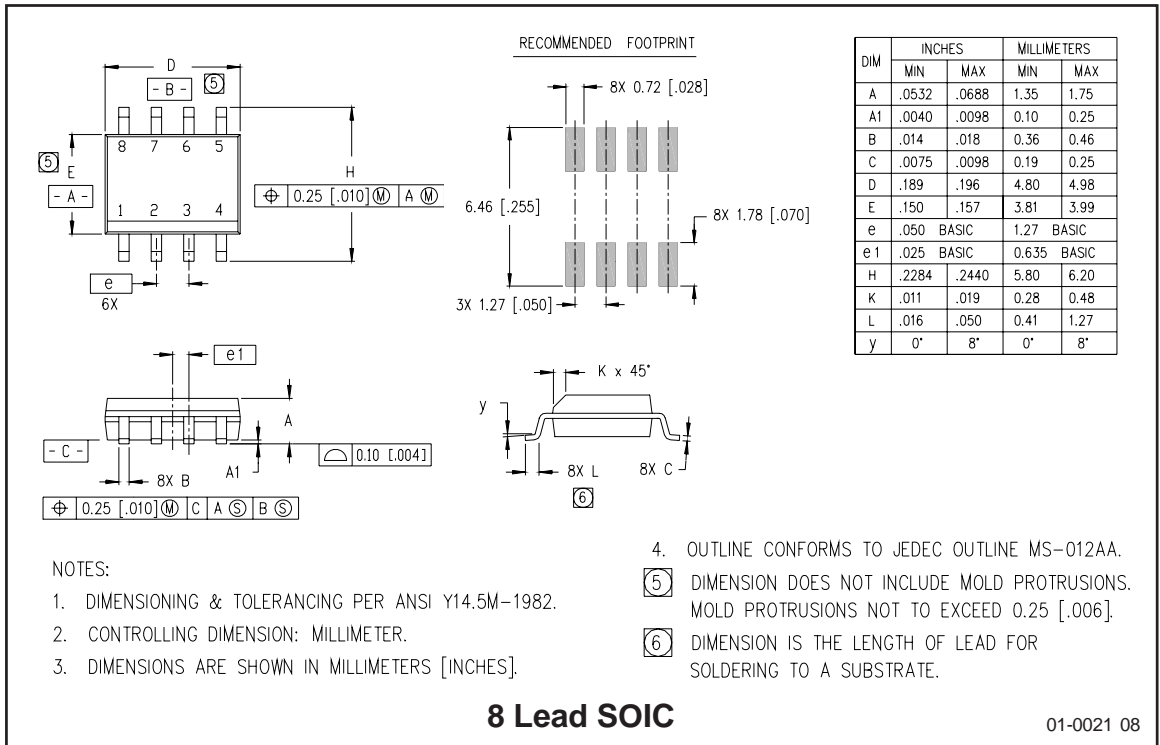
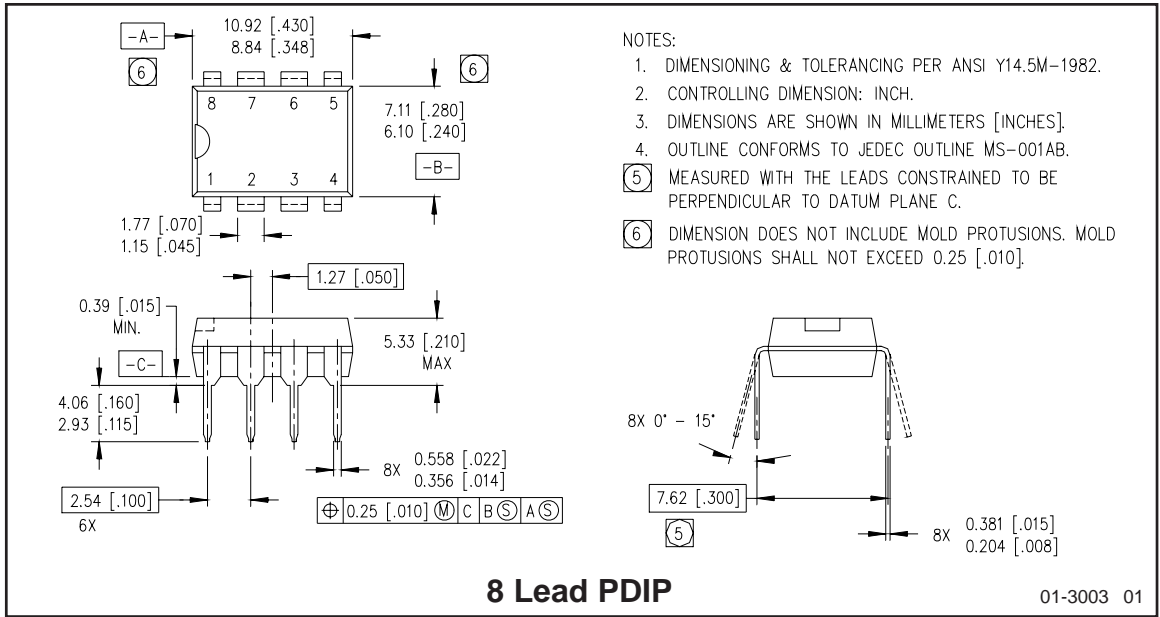

IR2153(D)(S) & (PbF)

NOTE: For new designs, we recommend IR's new product IRS2153D

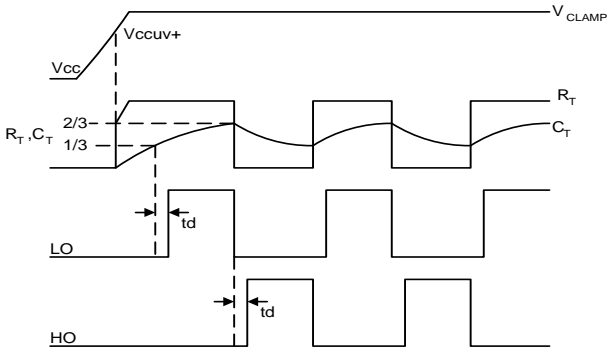

Figure 1. Input/Output Timing Diagram

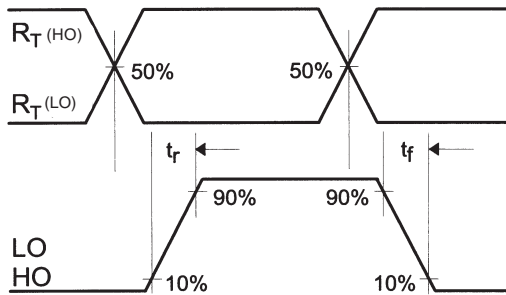

Figure 2. Switching Time Waveform Definitions

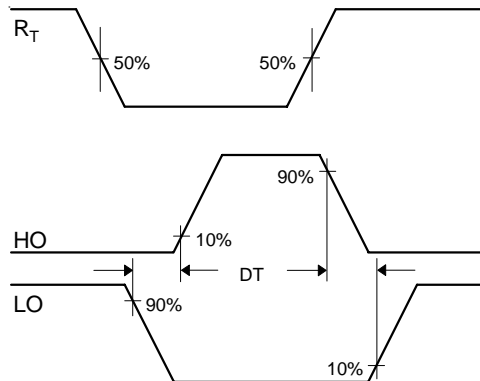
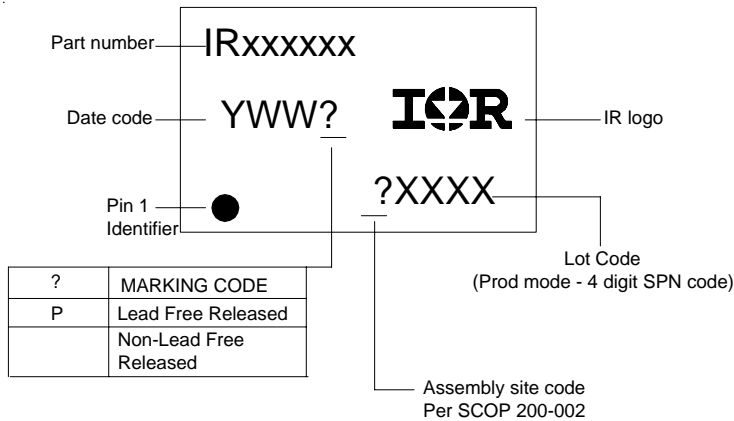

Figure 3. Deadtime Waveform Definitions

LEADFREE PART MARKING INFORMATION



ORDER INFORMATION

Basic Part (Non-Lead Free)

8-Lead PDIP IR2153 order IR2153
 8-Lead SOIC IR2153S order IR2153S
 8-Lead PDIP IR2153D order IR2153D

Leadfree Part

8-Lead PDIP IR2153 order IR2153PbF
 8-Lead SOIC IR2153S order IR2153SPbF
 8-Lead PDIP IR2153D order IR2153DPbF