

NOTES:

1. 詳細寸法については製品単体図面を参照ください。
RE DETAILED DIMENSION, SEE SALES DRAWING FOR CONNECTOR
2. 梱包数量 : 6000個/リール
NUMBER OF CONNECTOR : 6000PCS/REEL
3. リードテープ長さ
LEAD TAPE LENGTH

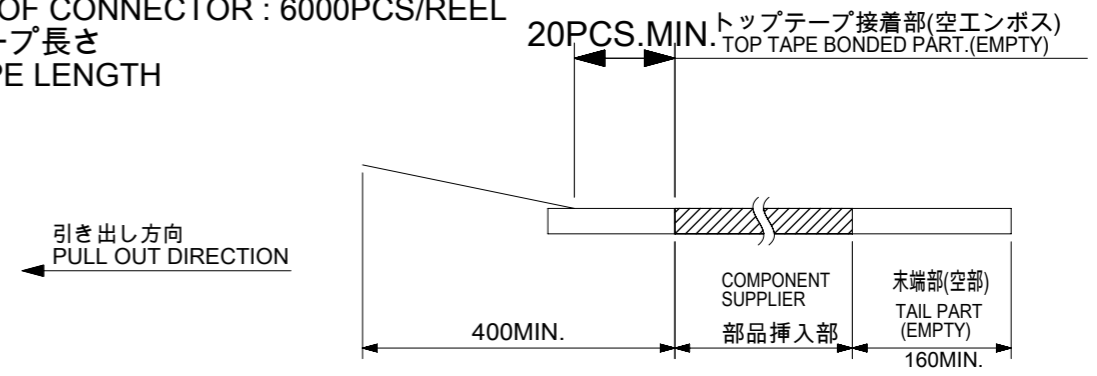

4. トップテープ剥離強度はIEC60286-3.準拠
PEEL-OFF FORCE OF TOP TAPE : BASED UPON IEC60286-3.
5. MATERIAL
CARRIER TAPE : POLYSTYREN(PS)
TOP TAPE : PET , OHTER
REEL : POLYSTYREN (PS) [RECYCLE MATERIAL CONTAINED]
6. ELV AND RoHS COMPLIANT

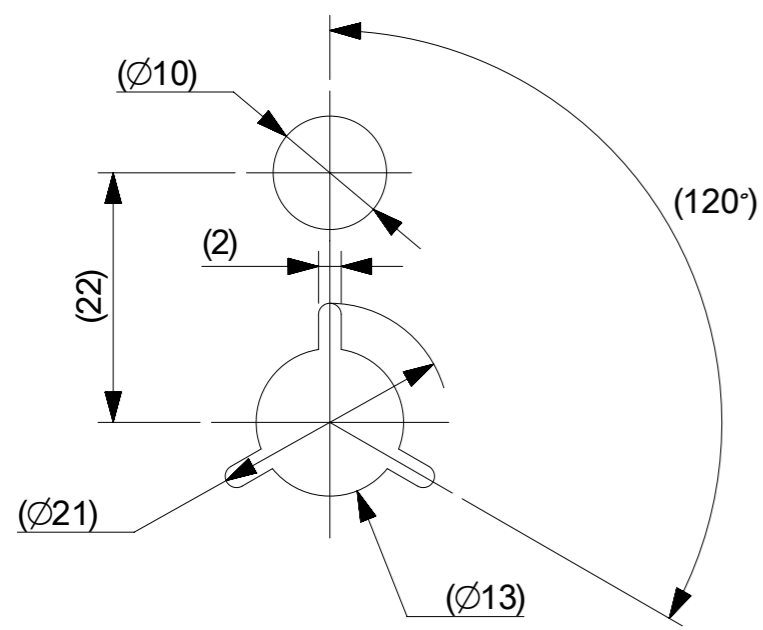

DETAIL "D"

MODEL NO. 505476**10

THIS DRAWING CONTAINS INFORMATION THAT IS PROPRIETARY TO MOLEX INCORPORATED AND SHOULD NOT BE USED WITHOUT WRITTEN PERMISSION											
EC DESCRIPTION	EC NO. 101345	GENERAL TOLERANCES (UNLESS SPECIFIED)		DIMENSION UNITS	SCALE	molex					
	DRWN: GMATSUNO	ANGULAR TOL $\pm 3.0^\circ$		mm	5:1						
	CHK'D: KMORIKAWA	4 PLACES ± 0.03	DRWN BY	DATE		0.4 BB CONN. RB PLUG O/M EMBSTP PKG.					
	APPR: KMORIKAWA	3 PLACES ± 0.03	GMATSUNO	2015/08/20							
		2 PLACES ± 0.05	CHK'D BY	DATE							
	1 PLACE ± 0.1	KTANAKA03		APPR BY		DATE		PRODUCT CUSTOMER DRAWING			
	0 PLACES ± 0.2	DRAFT WHERE APPLICABLE MUST REMAIN WITHIN DIMENSIONS		DRAWING SIZE	THIRD ANGLE PROJECTION	SERIES	MATERIAL NUMBER	CUSTOMER			
A	REV	A3		A3		505476	SEE CHART	GENERAL			
						DOCUMENT NUMBER	DOC TYPE	DOC PART	SHEET NUMBER		
						5054760000	PSD	000	1 OF 2		

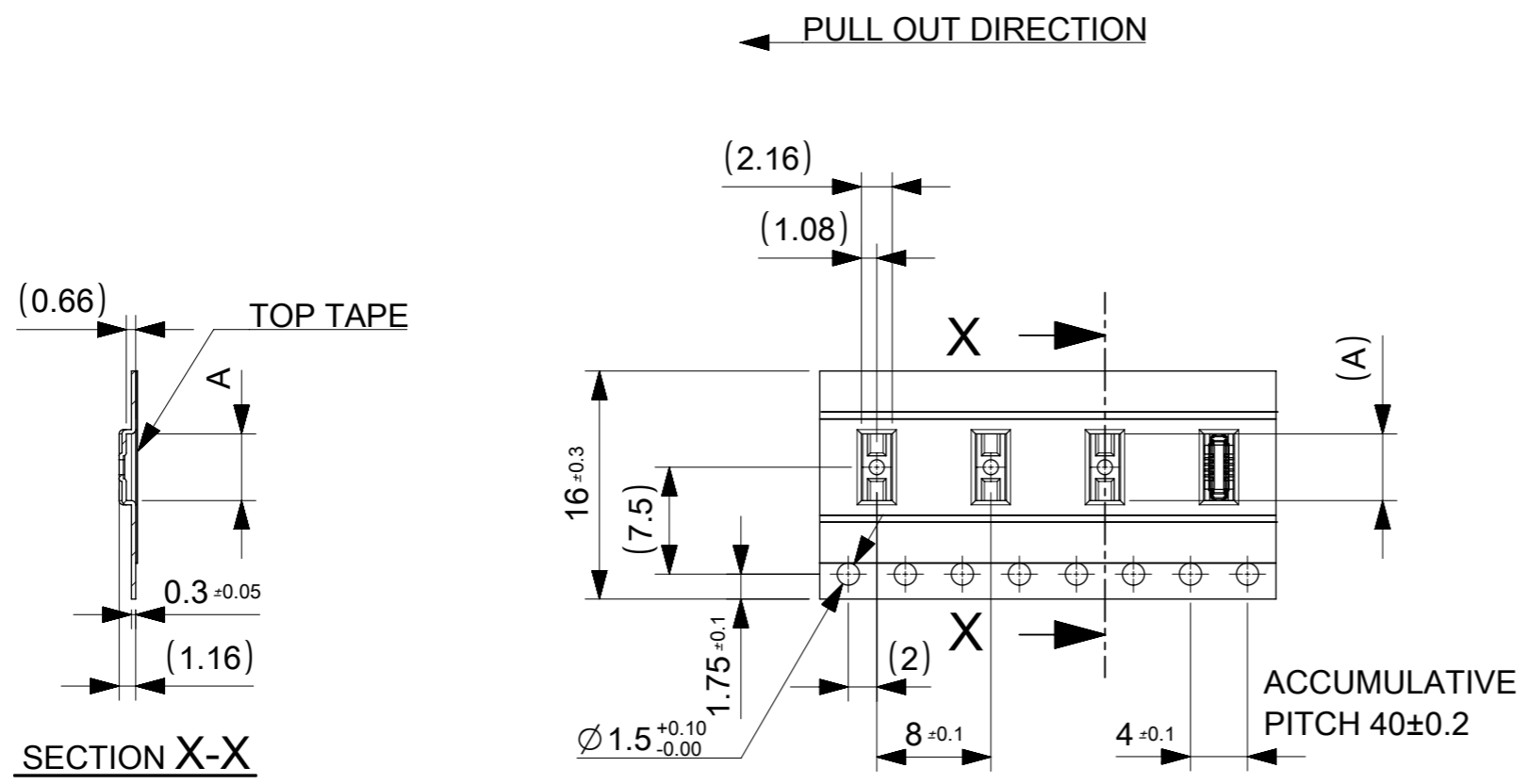

16	4.68	4	8	5054761210	---	---	12
	4.28	4	6	5054761010	○	---	10
	3.88	4	4	5054760810	○	---	8
キャリアテープ幅 CARRIER TAPE WIDTH	A	FOR POWER	FOR SIGNAL	EMBOSSED TAPE PACKAGE	HIGH VOL. TOOL	LOW VOL. TOOL	CIRCUIT
		USAGE		ORDER NO.	SAMPLE PREPARATION ○: TOOLED △: WORK IN PROCESS ---: TOOLING TO BE CONFIRMED		

THIS DRAWING CONTAINS INFORMATION THAT IS PROPRIETARY TO MOLEX INCORPORATED AND SHOULD NOT BE USED WITHOUT WRITTEN PERMISSION

EC NO: 101345 DRWN: GMATSUNO CHK'D: KMORIKAWA APPR: KMORIKAWA 2015/08/20 2015/10/13 2015/10/13	GENERAL TOLERANCES (UNLESS SPECIFIED)		DIMENSION UNITS	SCALE					
	ANGULAR TOL ± 3.0 °		mm	2:1					
	4 PLACES ± 0.03	DRWN BY		DATE		0.4 BB CONN. RB PLUG O/M EMBSTP PKG.			
	3 PLACES ± 0.03	GMATSUNO		2015/08/20					
	2 PLACES ± 0.05	CHK'D BY		DATE		PRODUCT CUSTOMER DRAWING			
1 PLACE ± 0.1	KTANAKA03								
0 PLACES ± 0.2	APPR BY		DATE		SERIES	MATERIAL NUMBER	CUSTOMER		
DRAFT WHERE APPLICABLE MUST REMAIN WITHIN DIMENSIONS	KMORIKAWA		2015/10/13		505476	SEE CHART	GENERAL		
	DRAWING SIZE	THIRD ANGLE PROJECTION		DOCUMENT NUMBER		DOC TYPE	DOC PART	SHEET NUMBER	
	A3			5054760000		PSD	000	2 OF 2	

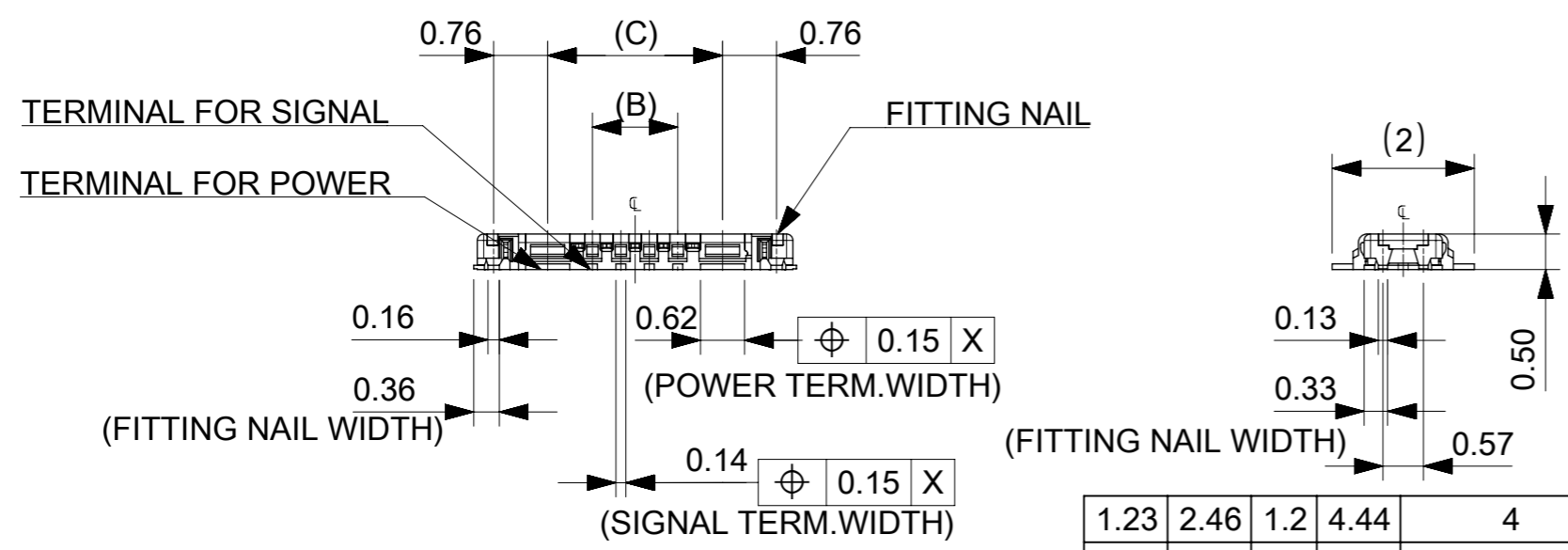
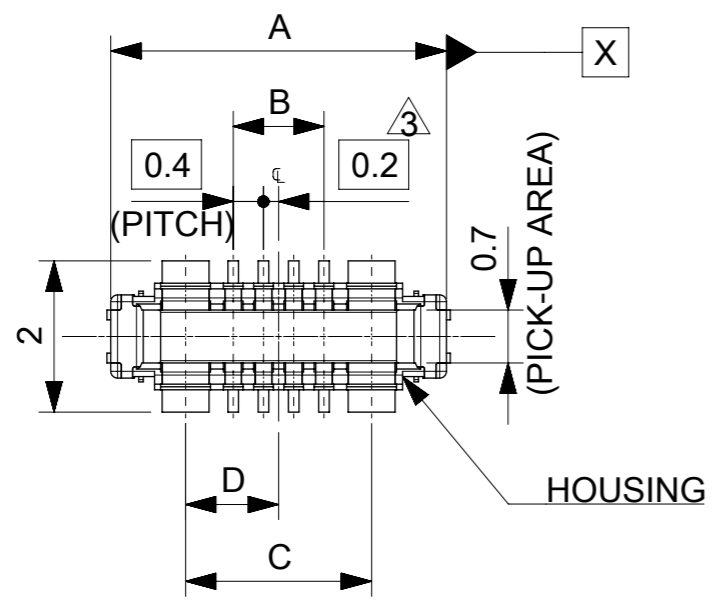

NOTES

- MATERIAL**
 HOUSING : LIQUID CRYSTAL POLYMER UL94V-0(COLOR : BLACK)
 TERMINAL FOR SIGNAL CIRCUIT : COPPER ALLOY
 TERMINAL FOR POWER CIRCUIT : COPPER ALLOY
 FITTING NAIL : COPPER ALLOY
- PLATING**
 TERMINAL FOR SIGNAL AND POWER CIRCUIT:
 GOLD
 UNDER PLATING : NICKEL
 *DIVIDE INTO PARTS THE GOLD PLATING OF THE CONTACT AND THE TAIL PART BY THE NICKEL PLATING.
 FITTING NAIL:
 GOLD(SOLDER TAIL)
 UNDER PLATING : NICKEL
- △ APPLY FOR (CIRCUIT/2)=EVEN.
- MATE WITH:505473 SERIES.
- TAIL AND FITTING NAIL COPLANARITY TO BE 0.08 MAXIMUM.
- △ PROHIBITED AREA OF PATTERN WIRING AND SOLDER.
 (FOR EACH AREA, THE WIRING THAT TOUCHES ON THE SOLDER CAN BE ATTACHED, THEN COVERED WITH A FILM TO KEEP SOLDER OUT.)
- ELV and RoHS COMPLIANT.

1.23	2.46	1.2	4.44	4	8	5054761210	---	---	12
1.03	2.06	0.8	4.04	4	6	5054761010	○	---	10
0.83	1.66	0.4	3.64	4	4	5054760810	○	---	8
D	C	B	A	FOR POWER	FOR SIGNAL	EMBOSSED TAPE PACKAGE	HIGH VOL. TOOL	LOW VOL. TOOL	CIRCUIT
USAGE						ORDER NO.	SAMPLE PREPARATION ○ : TOOLED △ : WORK IN PROCESS ---: TOOLING TO BE CONFIRMED		

CONNECTOR SERIES No. : 505476**09

THIS DRAWING CONTAINS INFORMATION THAT IS PROPRIETARY TO MOLEX INCORPORATED AND SHOULD NOT BE USED WITHOUT WRITTEN PERMISSION

EC NO: 101345 DRWN: GMATSUNO CHK'D: KMORIKAWA APPR: KMORIKAWA	2015/07/28	GENERAL TOLERANCES (UNLESS SPECIFIED)		DIMENSION UNITS	SCALE	
	2015/10/13	ANGULAR TOL ± 3.0 °		mm	10:1	
	2015/10/13	4 PLACES ± 0.03	DRWN BY	DATE		
		3 PLACES ± 0.03	GMATSUNO	2015/07/28		
		2 PLACES ± 0.05	CHK'D BY	DATE		
	1 PLACE ± 0.1	KTANAKA03	APPR BY	DATE		
	0 PLACES ± 0.2	KMORIKAWA	2015/10/13			
DRAFT WHERE APPLICABLE MUST REMAIN WITHIN DIMENSIONS			DRAWING SIZE	THIRD ANGLE PROJECTION		
A	REV	A3				

PRODUCT CUSTOMER DRAWING			
SERIES	MATERIAL NUMBER	CUSTOMER	
505476	SEE CHART	GENERAL	
DOCUMENT NUMBER	DOC TYPE	DOC PART	SHEET NUMBER
5054761000	PSD	000	1 OF 2

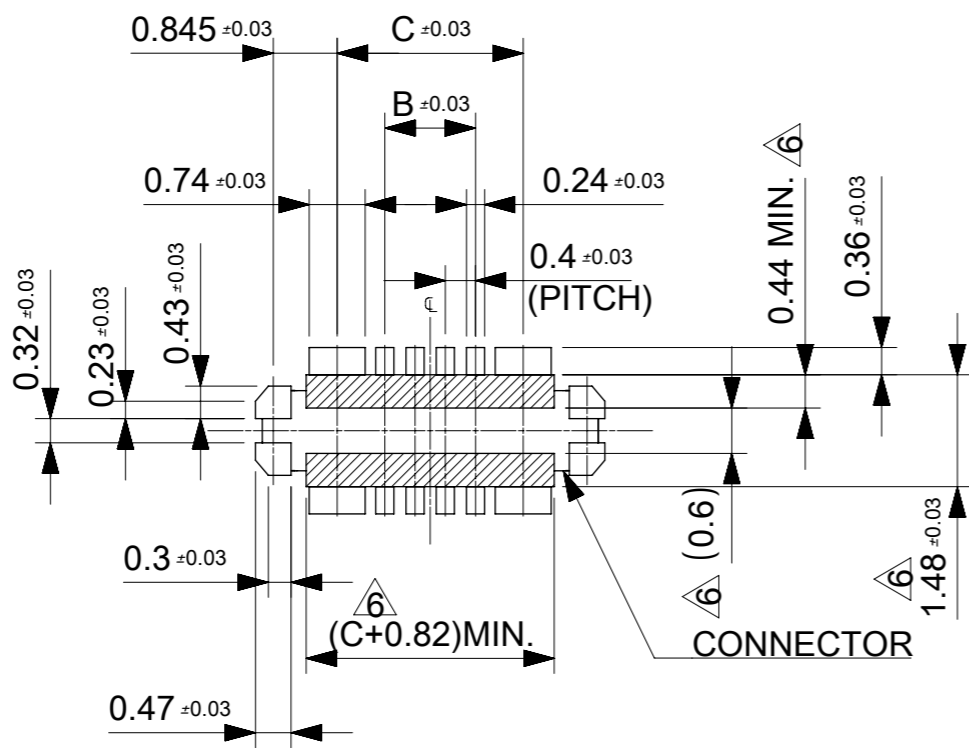

△ RECOMMENDED P.W. BOARD PATTERN LAYOUT (REFERENCE)
 PROHIBITED AREA OF PATTERN WIRING AND SOLDER.
 (FOR EACH AREA, THE WIRING THAT TOUCHES ON THE SOLDER CAN BE ATTACHED, THEN COVERED WITH A FILM TO KEEP SOLDER OUT.)

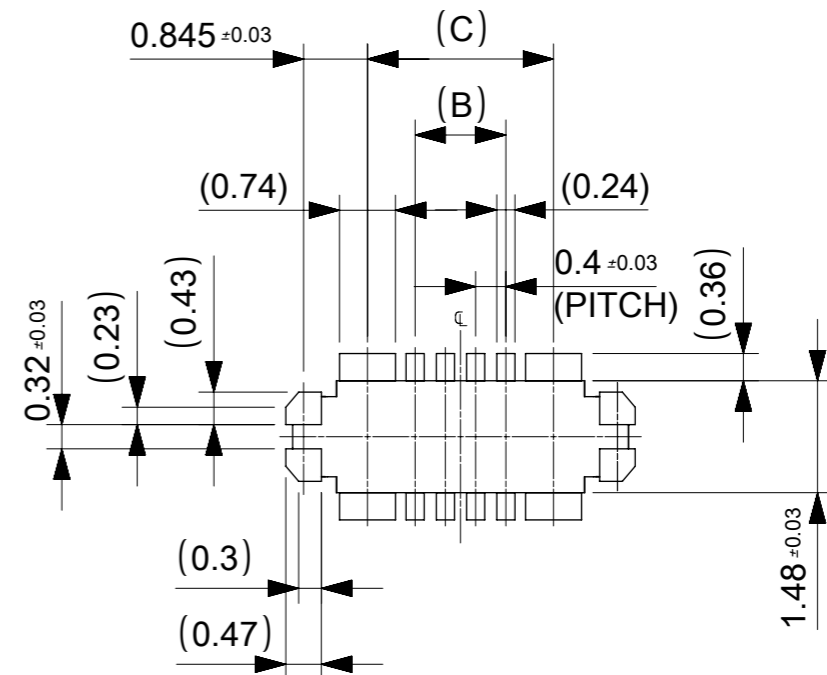

RECOMMENDED METAL MASK LAYOUT (REFERENCE)
 RECOMMENDED THICKNESS OF METAL MASK : t=0.08mm
 RECOMMENDED OPEN APERTURE RATIO OF METAL MASK : 100%

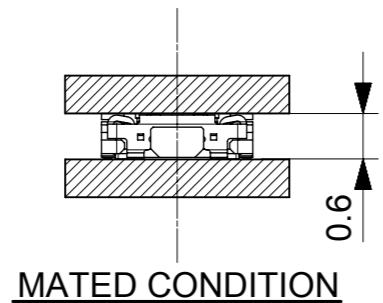

THIS DRAWING CONTAINS INFORMATION THAT IS PROPRIETARY TO MOLEX INCORPORATED AND SHOULD NOT BE USED WITHOUT WRITTEN PERMISSION

EC NO: 101345 DRWN: GMATSUNO CHK'D: KMORIKAWA APPR: KMORIKAWA	2015/07/28 2015/10/13 2015/10/13	GENERAL TOLERANCES (UNLESS SPECIFIED) ANGULAR TOL ± 3.0 °	DIMENSION UNITS: mm SCALE: 10:1			
	4 PLACES ± 0.03 3 PLACES ± 0.03 2 PLACES ± 0.05 1 PLACE ± 0.1 0 PLACES ± 0.2	DRWN BY: GMATSUNO DATE: 2015/07/28	CHK'D BY: KTANAKA03 DATE:			
	DRAFT WHERE APPLICABLE MUST REMAIN WITHIN DIMENSIONS	APPR BY: KMORIKAWA DATE: 2015/10/13	DRAWING SIZE: A3 THIRD ANGLE PROJECTION	PRODUCT CUSTOMER DRAWING		
				SERIES: 505476 MATERIAL NUMBER: SEE CHART CUSTOMER: GENERAL		
				DOCUMENT NUMBER: 5054761000 DOC TYPE: PSD DOC PART: 000 SHEET NUMBER: 2 OF 2		