

650 V power Schottky silicon carbide diode

Datasheet - production data

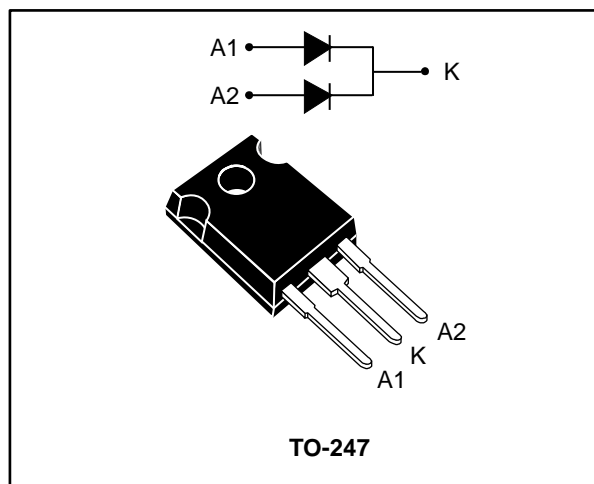

Description

The SiC diode is a high voltage power Schottky diode. It is manufactured using a silicon carbide substrate. The wide band gap material allows the design of a Schottky diode structure with a 650 V rating. Due to the Schottky construction, no recovery is shown at turn-off and ringing patterns are negligible. The minimal capacitive turn-off behavior is independent of temperature.

Used as a freewheeling or output rectification diode, this rectifier will enhance the performance and form factor of the targeted power supply or inverter.

Table 1: Device summary

Symbol	Value
$I_{F(AV)}$	2 x 20 A
V_{RRM}	650 V
T_j (max.)	175 °C
V_F (typ.)	1.30 V

Features

- No reverse recovery charge in application current range
- Switching behavior independent of temperature
- Dedicated to PFC applications
- ECOPACK®2 compliant component

1 Characteristics

Table 2: Absolute ratings per diode (limiting values at 25 °C unless otherwise specified)

Symbol	Parameter		Value	Unit
V _{RRM}	Repetitive peak reverse voltage		650	V
I _{F(RMS)}	Forward rms current		40	A
I _{F(AV)}	Average forward current	T _c = 140 °C ⁽¹⁾ , DC, per diode	20	A
		T _c = 130 °C ⁽¹⁾ , DC, per device	40	
I _{FRM}	Repetitive peak forward current	T _c = 140 °C, T _j = 175 °C, δ = 0.1	87	A
I _{FSM}	Surge non repetitive forward current	t _p = 10 ms sinusoidal, T _c = 25 °C	90	A
		t _p = 10 ms sinusoidal, T _c = 125 °C	70	
		t _p = 10 μs square, T _c = 25 °C	400	
T _{stg}	Storage temperature range		-55 to +175	°C
T _j	Operating junction temperature range ⁽²⁾		-40 to +175	°C

Notes:

⁽¹⁾Value based on R_{th(j-c)} max.

⁽²⁾(dP_{tot}/dT_j) < (1/R_{th(j-a)}) condition to avoid thermal runaway for a diode on its own heatsink.

Table 3: Thermal parameters

Symbol	Parameter		Value	Unit
R _{th(j-c)}	Junction to case	Per diode	0.90	°C/W
		Total	0.60	
R _{th(c)}	Coupling		0.30	

Table 4: Static electrical characteristics (per diode)

Symbol	Parameter	Test conditions		Min.	Typ.	Max.	Unit
I _R ⁽¹⁾	Reverse leakage current	T _j = 25 °C	V _R = V _{RRM}	-	30	300	μA
		T _j = 150 °C		-	280	2000	
		T _j = 25 °C	V _R = 600 V	-	15	150	
V _F ⁽²⁾	Forward voltage drop	T _j = 25 °C	I _F = 20 A	-	1.30	1.45	V
		T _j = 150 °C		-	1.45	1.65	
		T _j = 175 °C		-	1.50		

Notes:

⁽¹⁾Pulse test: t_p = 5 ms, δ < 2%

⁽²⁾Pulse test: t_p = 500 μs, δ < 2%

To evaluate the conduction losses use the following equation:

$$P = 1.02 \times I_{F(AV)} + 0.039 \times I_{F(RMS)}^2$$

Table 5: Dynamic electrical characteristics (per diode)

Symbol	Parameter	Test conditions	Min.	Typ.	Max.	Unit
$Q_{cj}^{(1)}$	Total capacitive charge	$V_R = 400 \text{ V}$	-	62	-	nC
C_j	Total capacitance	$V_R = 0 \text{ V}, T_c = 25 \text{ }^\circ\text{C}, F = 1 \text{ MHz}$	-	1250	-	pF
		$V_R = 400 \text{ V}, T_c = 25 \text{ }^\circ\text{C}, F = 1 \text{ MHz}$	-	100	-	

Notes:

⁽¹⁾Most accurate value for the capacitive charge:

$$Q_{cj} = \int_0^{V_{OUT}} C_j(V_R) \cdot dV_R$$

1.1 Characteristics (curves)

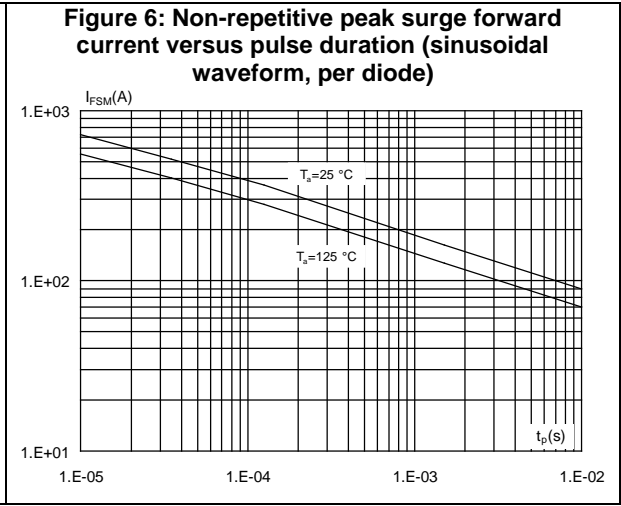
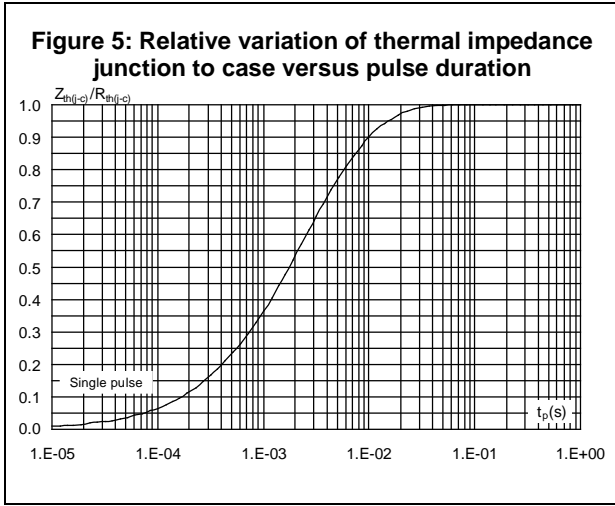
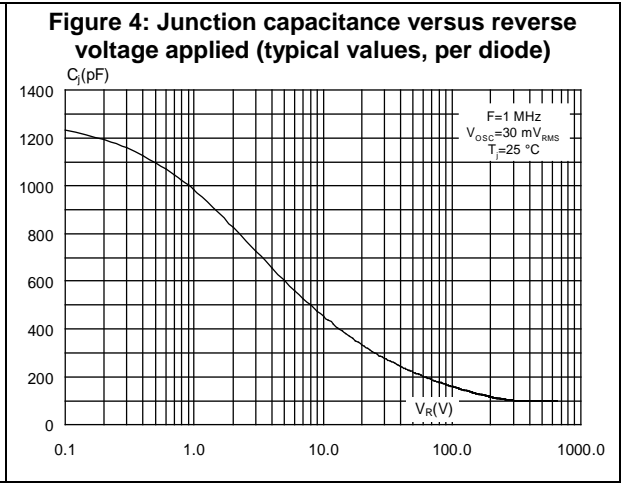
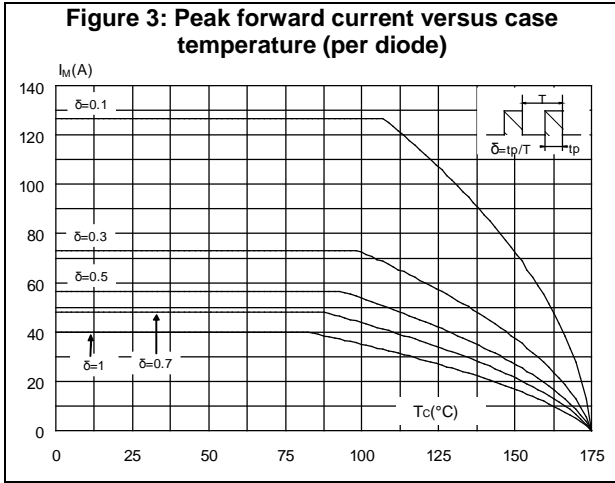
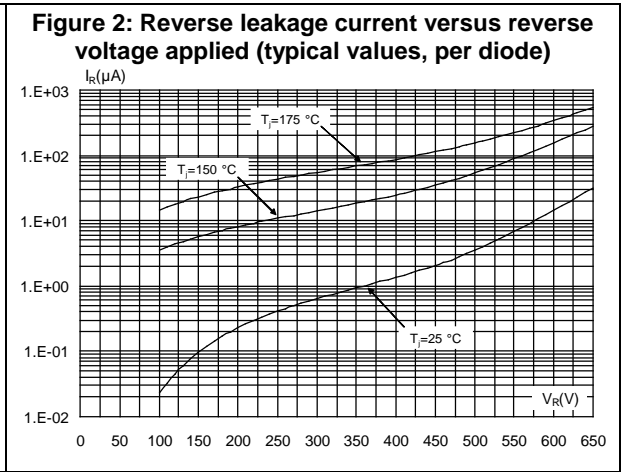
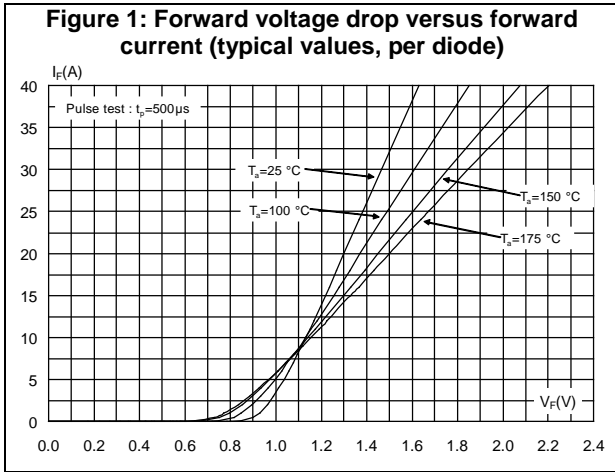
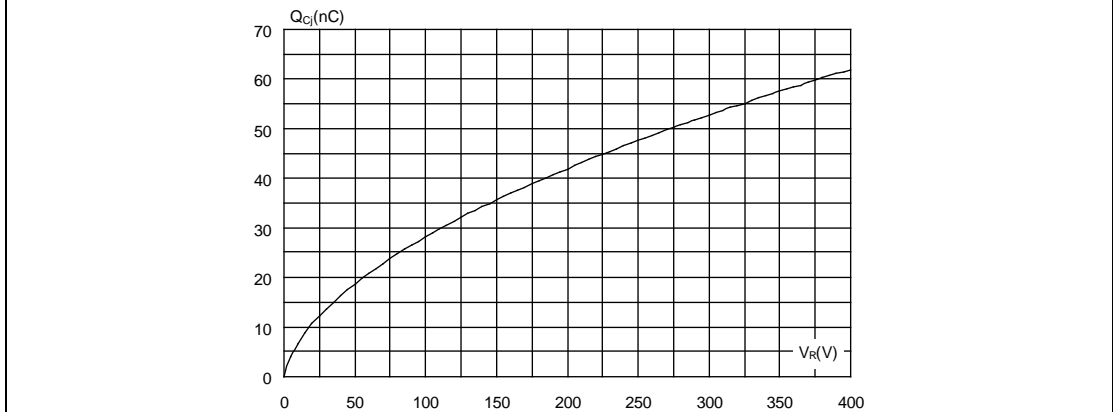

Figure 7: Total capacitive charges versus reverse voltage applied (typical values, per diode)



2 Package information

In order to meet environmental requirements, ST offers these devices in different grades of ECOPACK® packages, depending on their level of environmental compliance. ECOPACK® specifications, grade definitions and product status are available at: www.st.com. ECOPACK® is an ST trademark.

- Epoxy meets UL 94,V0
- Recommended torque value: 0.8 N·m
- Maximum torque value: 1 N·m

2.1 TO-247 package information

Figure 8: TO-247 package outline

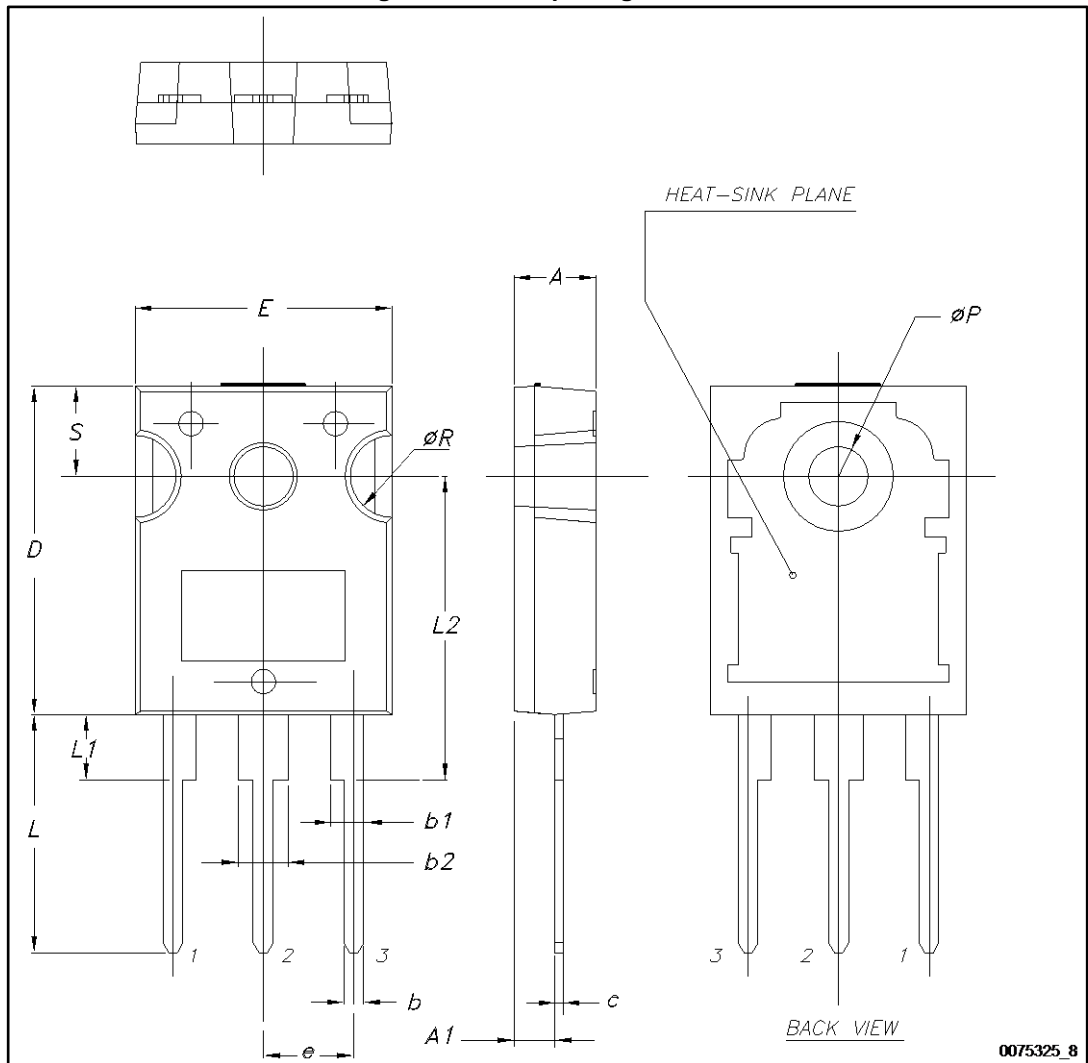

Table 6: TO-247 package mechanical data

Ref.	Dimensions					
	Millimeters			Inches		
	Min.	Typ.	Max.	Min.	Typ.	Max.
A	4.85		5.15	0.191		0.203
A1	2.20		2.60	0.086		0.102
b	1.00		1.40	0.039		0.055
b1	2.00		2.40	0.078		0.094
b2	3.00		3.40	0.118		0.133
c	0.40		0.80	0.015		0.031
D ⁽¹⁾	19.85		20.15	0.781		0.793
E	15.45		15.75	0.608		0.620
e	5.30	5.45	5.60	0.209	0.215	0.220
L	14.20		14.80	0.559		0.582
L1	3.70		4.30	0.145		0.169
L2		18.50			0.728	
ØP ⁽²⁾	3.55		3.65	0.139		0.143
ØR	4.50		5.50	0.177		0.217
S	5.30	5.50	5.70	0.209	0.216	0.224

Notes:

⁽¹⁾Dimension D plus gate protusion does not exceed 20.5 mm

⁽²⁾Resin thickness around the mounting hole is not less than 0.9 mm.

3 Ordering information

Table 7: Ordering information

Order code	Marking	Package	Weight	Base qty.	Delivery mode
STPSC40065CW	PSC40065CW	TO-247	4.43 g	30	Tube

4 Revision history

Table 8: Document revision history

Date	Revision	Changes
19-Jun-2015	1	First issue.
17-May-2016	2	Datasheet curves and device parameters updated following optimization of the die layout.
27-Sep-2016	3	Updated Section 1: "Characteristics" .

IMPORTANT NOTICE – PLEASE READ CAREFULLY

STMicroelectronics NV and its subsidiaries ("ST") reserve the right to make changes, corrections, enhancements, modifications, and improvements to ST products and/or to this document at any time without notice. Purchasers should obtain the latest relevant information on ST products before placing orders. ST products are sold pursuant to ST's terms and conditions of sale in place at the time of order acknowledgement.

Purchasers are solely responsible for the choice, selection, and use of ST products and ST assumes no liability for application assistance or the design of Purchasers' products.

No license, express or implied, to any intellectual property right is granted by ST herein.

Resale of ST products with provisions different from the information set forth herein shall void any warranty granted by ST for such product.

ST and the ST logo are trademarks of ST. All other product or service names are the property of their respective owners.

Information in this document supersedes and replaces information previously supplied in any prior versions of this document.

© 2016 STMicroelectronics – All rights reserved