

TMG4903

Gesture, Color and Proximity Sensor Module with mobeam™ Barcode Emulation and IR Remote Control

General Description

The TMG4903 features ambient light and color (RGB) sensing, proximity detection, and IRBeam optical pattern generator capable of mobeam™ barcode emulation and IR remote control in parallel. In addition, the device integrates an IR LED and advanced LED driver, all within a low-profile and small footprint, 2.0mm x 5.0mm x 1.0mm package.

The Gesture and Proximity sensing function synchronizes IR emission and detection to sense gesture and proximity events. The architecture of the engine features automatic high sample rate activation, self-maximizing dynamic range, ambient light subtraction, advanced crosstalk cancelation, 14-bit data output, 32-dataset FIFO, and interrupt-driven I²C communication. Sensitivity, power consumption, and noise can be optimized with adjustable IR LED timing and power. The gesture engine is capable of 3D detection of motion and position. Gesture interrupts are configurable to reduce I²C communication load. The proximity engine recognizes detect/release events and produces a configurable interrupt whenever proximity result crosses upper or lower threshold settings.

The Ambient Light and Color Sensing function provides Red, Green, and Blue (RGB) ambient light sensing with a Clear reference (C). The color diode array has a UV/IR blocking filter and parallel ADCs to produce simultaneous 16-bit results. This architecture accurately measures ambient light and enables the calculation of illuminance, chromaticity, and color temperature to manage display appearance.

The IRBeam pattern generator supports mobeam™ barcode emulation and IR remote control. The engine features RAM for pattern storage and specialized control logic that is tailored to repetitively broadcast a barcode pattern using the integrated LED or an external LED with a low side driver. The IRBeam engine features adjustable timing, looping, and IR intensity to maximize successful transmission. IRBeam is designed to support all requirements for 1-D barcode transmission over IR to point-of-sale (POS) terminals as well as IR remote control.

Ordering Information and Content Guide appear at end of datasheet.

Key Benefits & Features

The benefits and features of TMG4903, Gesture, Color and Proximity Sensor Module with mobeam™ Barcode Emulation and IR Remote Control are listed below:

Figure 1:
Added Value of Using TMG4903

Benefit	Feature
<ul style="list-style-type: none"> • 2D and 3D gesture and proximity detection 	<ul style="list-style-type: none"> • Automatic sample rate adjustment ⁽¹⁾ • Self-maximizing dynamic range ⁽²⁾ • 2D and 3D gesture detect • Ambient light rejection • Advanced crosstalk compensation • AFE saturation flag • Programmable LED driver • Interrupt-driven I²C communication
<ul style="list-style-type: none"> • Ambient light and color sensing 	<ul style="list-style-type: none"> • Variable sensitivity • Designed to operate behind inked glass • UV/IR blocking filter • Programmable gain and integration time • 6.7M:1 dynamic range by gain adjustment only • Interrupt-driven I²C communication
<ul style="list-style-type: none"> • IRBeam pattern generator 	<ul style="list-style-type: none"> • mobeam™ support • Universal remote control support • Interrupt-driven I²C communication
<ul style="list-style-type: none"> • Integrated LED and driver 	<ul style="list-style-type: none"> • Calibrated emission and response • Invisible 950nm emission
<ul style="list-style-type: none"> • Low supply voltage 	<ul style="list-style-type: none"> • 1.8V operation

Note(s):

1. While an object is detected, the sample rate increases automatically to improve response.
2. Device sensitivity is automatically adjusted based on reflected response to support a wide detection distance.

Applications

The TMG4903 applications include:

- Gesture detection
- Color sensing
- Ambient light sensing
- Cell phone touch screen disable
- Mechanical switch replacement
- 1D bar code emulation
- Universal remote control

Block Diagram

The functional blocks of this device are shown below:

Figure 2:
TMG4903 Block Diagram

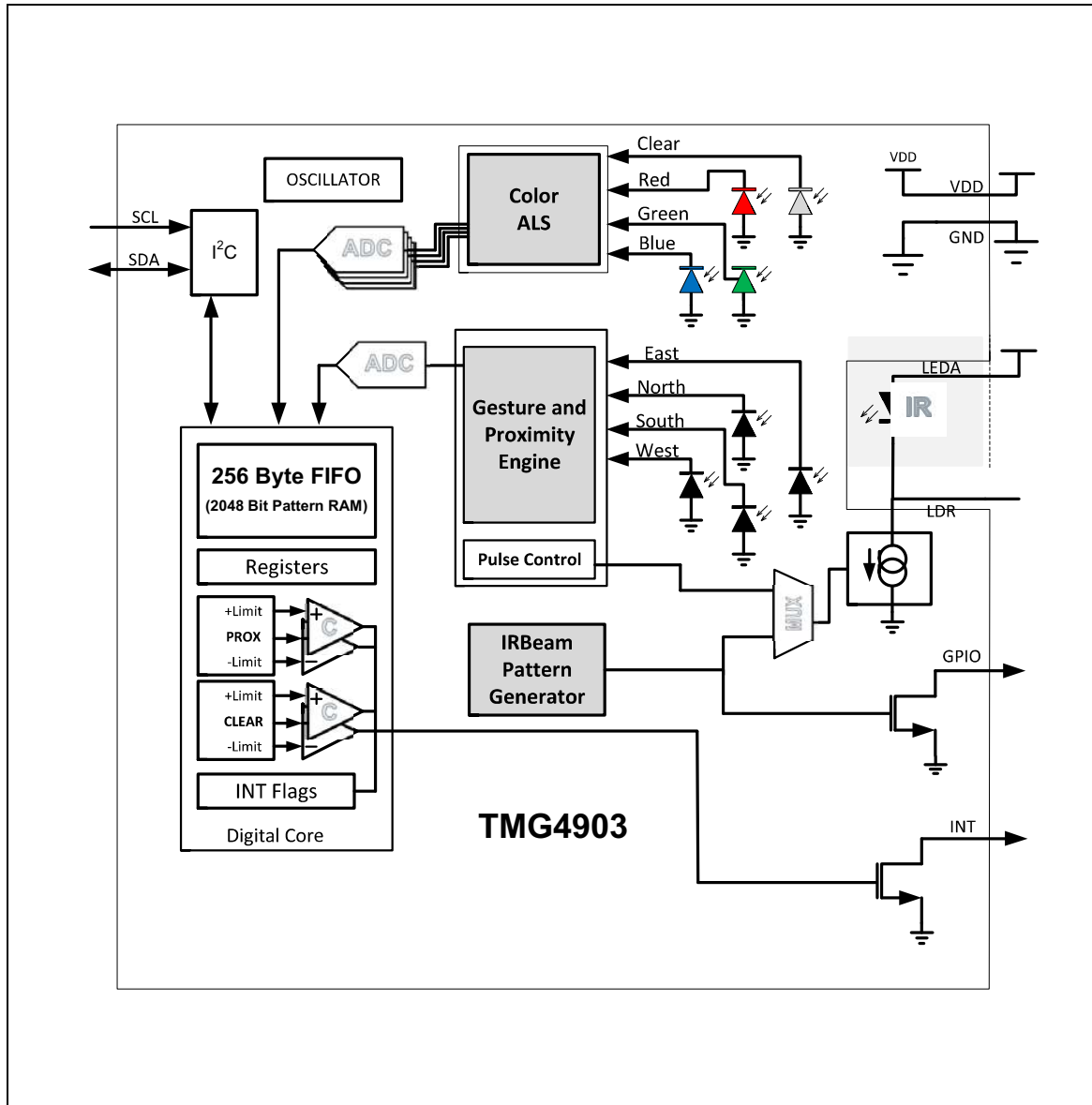

Pin Assignment

The device pin assignments are described below.

Figure 3:
Pin Diagram

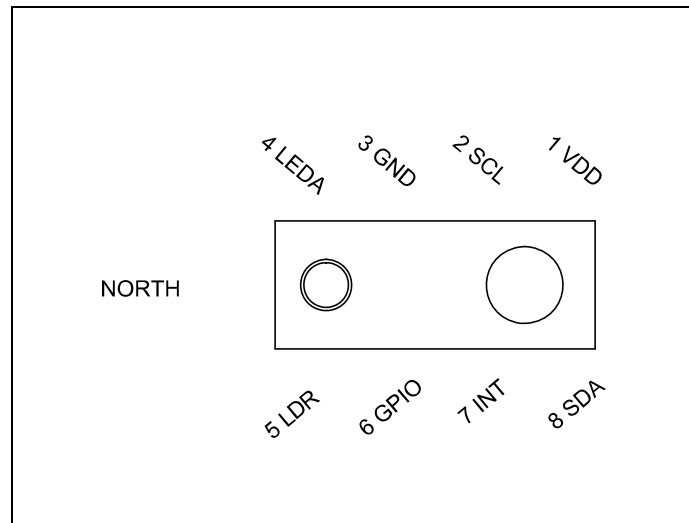

Pin Description

Figure 4:
Pin Description

Pin Number	Pin Name	Description
1	V _{DD}	Supply voltage (1.8V)
2	SCL	I ² C serial clock terminal
3	GND	Ground. All voltages are referenced to GND
4	LEDA	LED anode
5	LDR	LED driver (sinks current) and LED cathode (for direct access to LED)
6	GPIO	Open drain IRBeam output or alternate interrupt
7	INT	Interrupt. Open drain output and logic level output for external IR LED circuit
8	SDA	I ² C serial data I/O terminal

Absolute Maximum Ratings

Stresses beyond those listed under Absolute Maximum Ratings may cause permanent damage to the device. These are stress ratings only. Functional operation of the device at these or any other conditions beyond those indicated under [Recommended Operating Conditions](#) is not implied. Exposure to absolute maximum rating conditions for extended periods may affect device reliability.

Figure 5:
Absolute Maximum Ratings

Symbol	Parameter	Min	Max	Units	Comments
V_{DD}	Supply voltage	-0.3	2.2	V	
V_{LEDA}	LED anode supply	-0.3	3.6	V	
V_{IO}	Digital I/O terminal voltage	-0.3	3.6	V	
V_{LDR}	Terminal voltage	-0.3	3.6	V	See note (2)
I_{IO}	Output terminal current	-1	20	mA	
T_{strg}	Storage temperature range	-40	85	°C	
ESD_{HBM}	ESD tolerance, human body model	±2000		V	

Note(s):

1. All voltages with respect to GND
2. Measured with LDR = OFF or LDR = ON and LDRIVE = 310mA.

Electrical Characteristics

The parameters with min and max values are guaranteed with production tests or SQC (Statistical Quality Control) methods.

Figure 6:
Recommended Operating Conditions

Symbol	Parameter	Min	Typ	Max	Units
V_{DD}	Supply voltage	1.7	1.8	2.0	V
T_A	Operating free-air temperature ⁽¹⁾	-30		85	°C

Note(s):

1. While the device is operational across the temperature range, functionality will vary with temperature. Specifications are stated at 25°C, unless otherwise noted.

Figure 7:
Operating Characteristics, $V_{DD} = 1.8\text{ V}$, $T_A = 25^\circ\text{C}$ (unless otherwise noted)

Symbol	Parameter	Conditions	Min	Typ	Max	Units
f_{OSC}	Oscillator frequency			8.1		MHz
I_{DD}	Supply current ⁽¹⁾	Active ALS state (PON=AEN=1, PEN=IBEN=0) ⁽²⁾		150	200	μA
		Idle state (PON=1, AEN=PEN=IBEN=0) ⁽³⁾		30	60	
		Sleep state ⁽⁴⁾		0.4	5	
V_{OL}	INT, SDA, GPIO output low voltage	6 mA sink current			0.6	V
I_{LEAK}	Leakage current, SDA, SCL, INT, GPIO, LDR pins		-5		5	μA
V_{IH}	SCL, SDA input high voltage		1.26			V
V_{IL}	SCL, SDA input low voltage				0.54	V

Note(s):

1. Values are shown at the VDD pin and do not include current through the IR LED.
2. This parameter indicates the supply current during periods of ALS integration. If Wait is enabled (WEN=1), the supply current is lower during the Wait period.
3. Idle state occurs when PON=1 and all functions are not enabled.
4. Sleep state occurs when PON = 0 and I²C bus is idle. If Sleep state has been entered as the result of operational flow, SAI = 1, PON will remain high.

Figure 8:
ALS/Color Operating Characteristics, VDD = 1.8 V, T_A = 25°C, AGAIN = 16x, ATIME = 0xF6 (unless otherwise noted)

Parameter	Conditions	Min	Typ	Max	Units
Integration time step size ^{(1), (2)}		2.68	2.78	2.90	ms
Dark ADC count value ⁽²⁾	E _e = 0 μW/ cm ² AGAIN: 64x ATIME: 100ms (0xDC)	0	1	3	counts
Gain scaling, relative to 16x gain setting	AGAIN: 1/4x	0.0135		0.0175	x
	AGAIN: 1x	0.058		0.067	
	AGAIN: 4x	0.237		0.263	
	AGAIN: 64x	3.75		4.37	
Clear channel irradiance responsivity	White LED, 2700K	8.94	10.28	11.62	counts/ (μW/ cm ²)
Lux accuracy ⁽³⁾	White LED, 2700K	90	100	110	%
ADC Noise ⁽⁴⁾	AGAIN: 16x		0.005		% Full Scale

Note(s):

1. Integration time is configured from 1 step (0xFF) to 256 steps (0x00) for a typical range of 2.78ms to 711.11ms. An ATIME setting of 0xFF results in a full-scale count value of 1024. Each additional integration step adds 1024 counts to full scale. To enable 16-bit ADC range, 64 or more integration steps (177.8ms or more) are required (ATIME ≤ 0xC0).
2. The typical 3-sigma distribution is between 0 and 1 count for an AGAIN setting of 16x.
3. Lux accuracy is function of red, green, blue and clear channels, and not 100% production tested.
4. ADC noise is calculated as the standard deviation of 1000 data samples.

Figure 9:
Color Ratio Characteristics, VDD = 1.8V, T_A = 25°C

Parameter	Test Conditions	Ratio of Color to Clear Channel					
		Red Channel		Green Channel		Blue Channel	
		Min	Max	Min	Max	Min	Max
Color ADC count value ratio: Color/Clear	White LED, 2700 K	45%	65%	19%	39%	15%	40%
	$\lambda_D = 465 \text{ nm}$ ⁽¹⁾	0%	15%	10%	42%	70%	90%
	$\lambda_D = 525 \text{ nm}$ ⁽²⁾	4%	25%	60%	85%	10%	45%
	$\lambda_D = 615 \text{ nm}$ ⁽³⁾	80%	110%	0%	14%	5%	24%

Note(s):

1. The 465 nm input irradiance is supplied by an InGaN light-emitting diode with the following characteristics: dominant wavelength $\lambda_D = 465 \text{ nm}$, spectral halfwidth $\Delta\lambda_{1/2} = 22 \text{ nm}$.
2. The 525 nm input irradiance is supplied by an InGaN light-emitting diode with the following characteristics: dominant wavelength $\lambda_D = 525 \text{ nm}$, spectral halfwidth $\Delta\lambda_{1/2} = 35 \text{ nm}$.
3. The 615 nm input irradiance is supplied by an AlInGaP light-emitting diode with the following characteristics: dominant wavelength $\lambda_D = 615 \text{ nm}$, spectral halfwidth $\Delta\lambda_{1/2} = 15 \text{ nm}$.

Figure 10:
Gesture and Proximity Operating Characteristics, VDD = 1.8 V, T_A = 25°C (unless otherwise noted)

Parameter	Conditions	Min	Typ	Max	Unit
ADC conversion time step size			20		μs
Offset (no target response) ⁽¹⁾	PGAIN = 2 (4x) PGLDRIVE = 7 (150mA) PGPULSE_LEN = 1 (8μs) No target present After electrical calibration		16	36	counts
Part to part variation ⁽²⁾	PGAIN = 2 (4x) PGLDRIVE = 1 (30mA) PGPULSE_LEN = 1 (8μs) d=23mm round target 30mm target distance After electrical calibration	75	100	125	%
Response, absolute ⁽³⁾	PGAIN = 2 (4x) PGLDRIVE = 7 (150mA) PGPULSE_LEN = 1 (8μs) 100x100mm, 90% reflective Kodak gray card 100mm target distance After electrical calibration	670	840	1010	counts
Photodiode relative deviation, north and south channels ⁽⁴⁾		-25		25	%
Photodiode relative deviation, east and west channels ⁽⁴⁾		-25		25	
Noise/Signal ⁽⁵⁾	PGAIN = 2 (4x) PGLDRIVE = 2 (50mA) PGPULSE_LEN = 1 (8μs) PGPULSE = 7 (8 pulses)			2	%

Note(s):

1. Offset varies with power supply characteristics and system noise.
2. Production tested result is the average of 5 readings expressed relative to a calibrated response.
3. Representative result by characterization. Device settings can vary from 1 to 64 pulse count, 4μs to 32μs pulse width, 10mA to 310mA current setting, and 1x to 8x electrical gain. Refer to [Figure 22](#) for device performance with different settings.
4. Relative mismatch in the response between opposing channels.
5. Production tested result is the standard deviation of 20 readings as a percentage of full scale response.

Figure 11:
Proximity Test Circuit

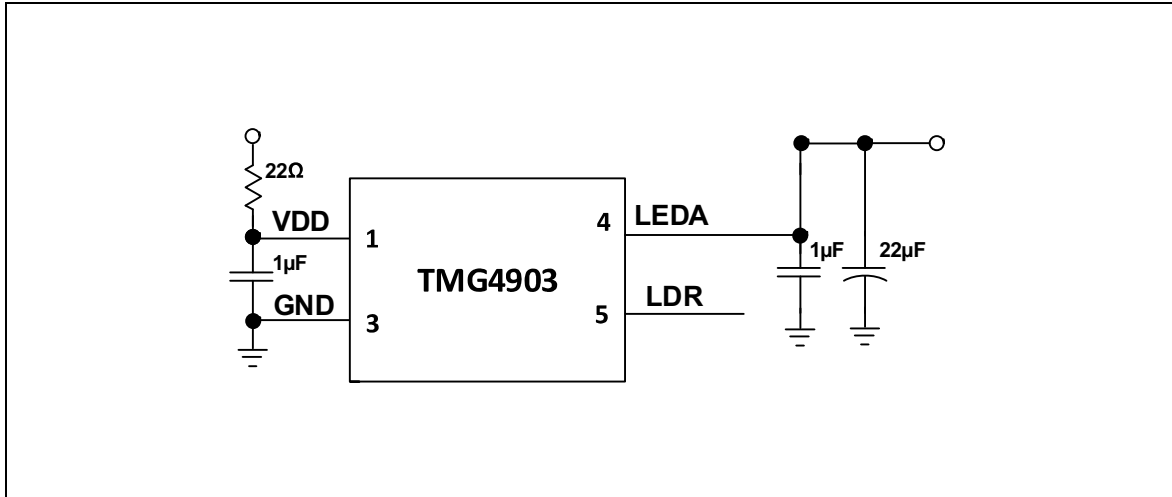

Figure 12:
Wait Characteristics, VDD = 1.8 V, T_A = 25°C, WEN = 1 (unless otherwise noted)

Parameter	Conditions	Min	Typ	Max	Units
Wait step size		2.68	2.78	2.90	ms
Long wait step size			33.3		ms

Figure 13:
IRBeam Operating Characteristics, VDD = 1.8 V, T_A = 25°C (unless otherwise noted)

Symbol	Parameter	Conditions	Min	Typ	Max	Units
t _(PBT min)	Minimum bit time	IBEN = 1		0.25		μs

Timing Characteristics

Figure 14:
AC Electrical Characteristics, VDD = 1.8 V, TA = 25°C (unless otherwise noted)

Parameter	Description	Min	Typ	Max	Unit
$f_{SCL}^{(1)}$	Clock frequency (I ² C only)	0		400	kHz
$t_{BUF}^{(1)}$	Bus free time between start and stop condition	1.3			μs
$t_{HS;STA}^{(1)}$	Hold time after (repeated) start condition. After this period, the first clock is generated.	0.6			μs
$t_{SU;STA}^{(1)}$	Repeated start condition setup time	0.6			μs
$t_{SU;STO}^{(1)}$	Stop condition setup time	0.6			μs
$t_{HD;DAT}^{(1)}$	Data hold time	0			ns
$t_{SU;DAT}^{(1)}$	Data setup time	100			ns
$t_{LOW}^{(1)}$	SCL clock low period	1.3			μs
$t_{HIGH}^{(1)}$	SCL clock high period	0.6			μs
$t_F^{(1)}$	Clock/data fall time			300	ns
$t_R^{(1)}$	Clock/data rise time			300	ns
$C_i^{(1)}$	Input pin capacitance			10	pF

Note(s):

1. Specified by design and characterization; not production tested.

Timing Diagram

Figure 15:
Timing Parameter Measurement Drawing

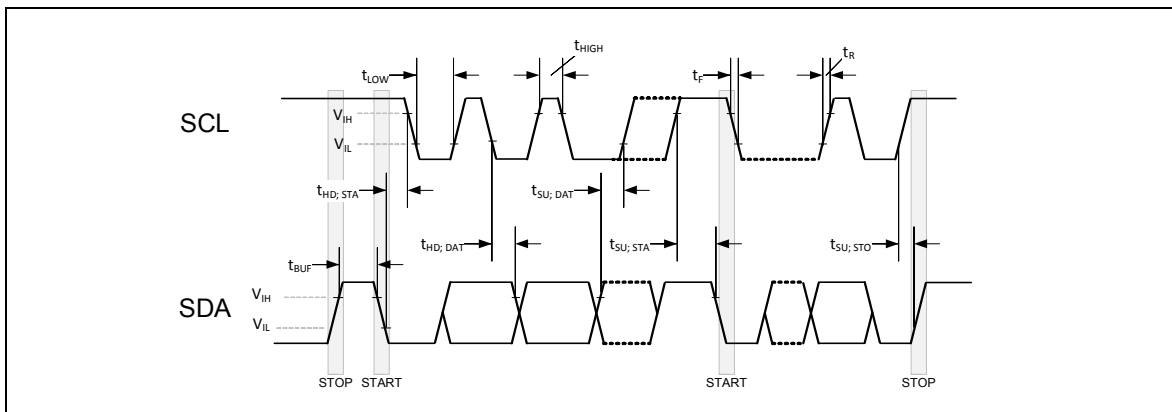

Typical Operating Characteristics

Figure 16:
Spectral Responsivity

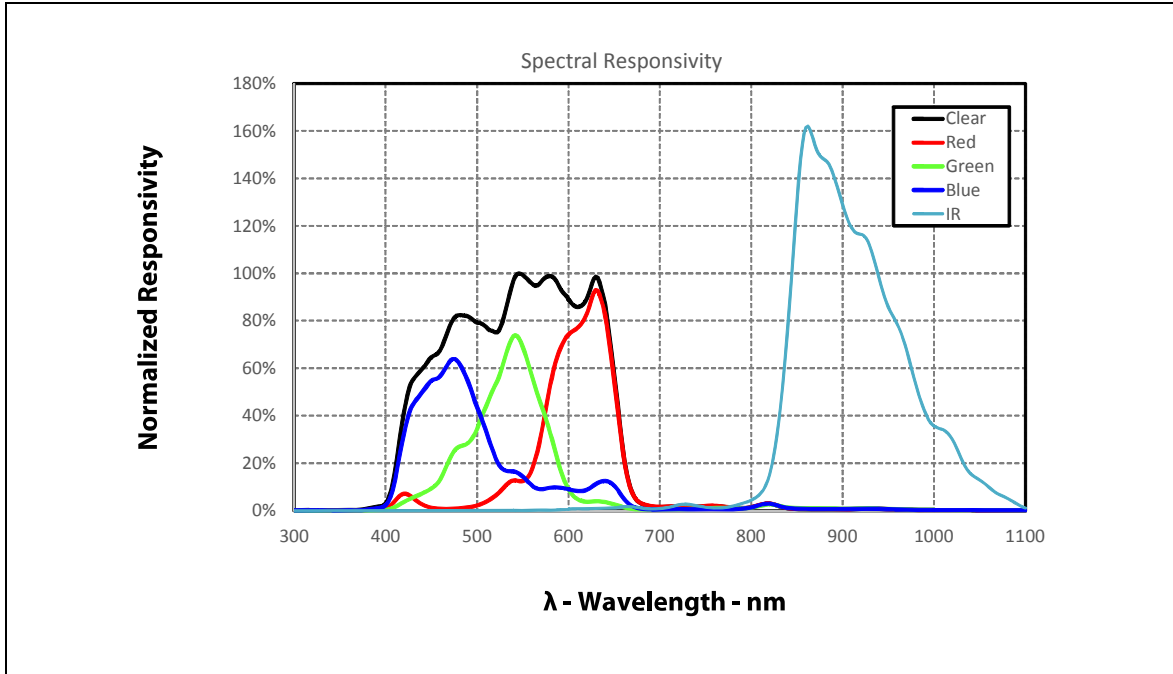

Figure 17:
CRGB Responsivity vs. Angular Displacement

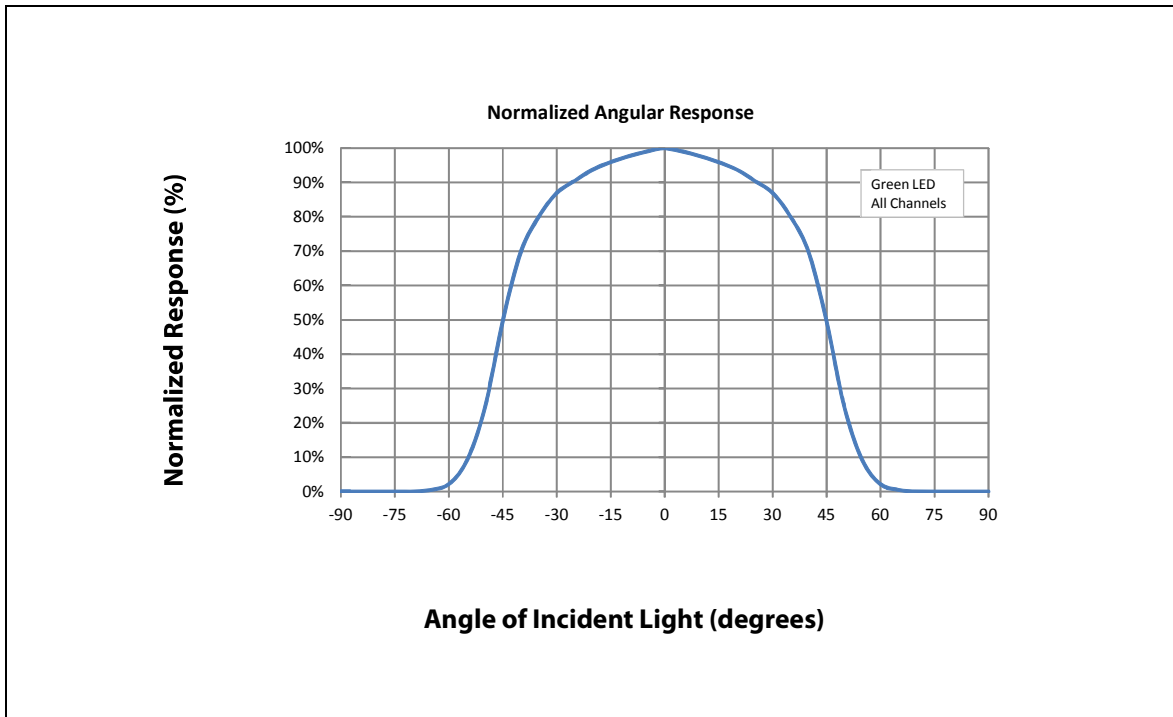

Figure 18:
Typical LDR Current vs. Voltage

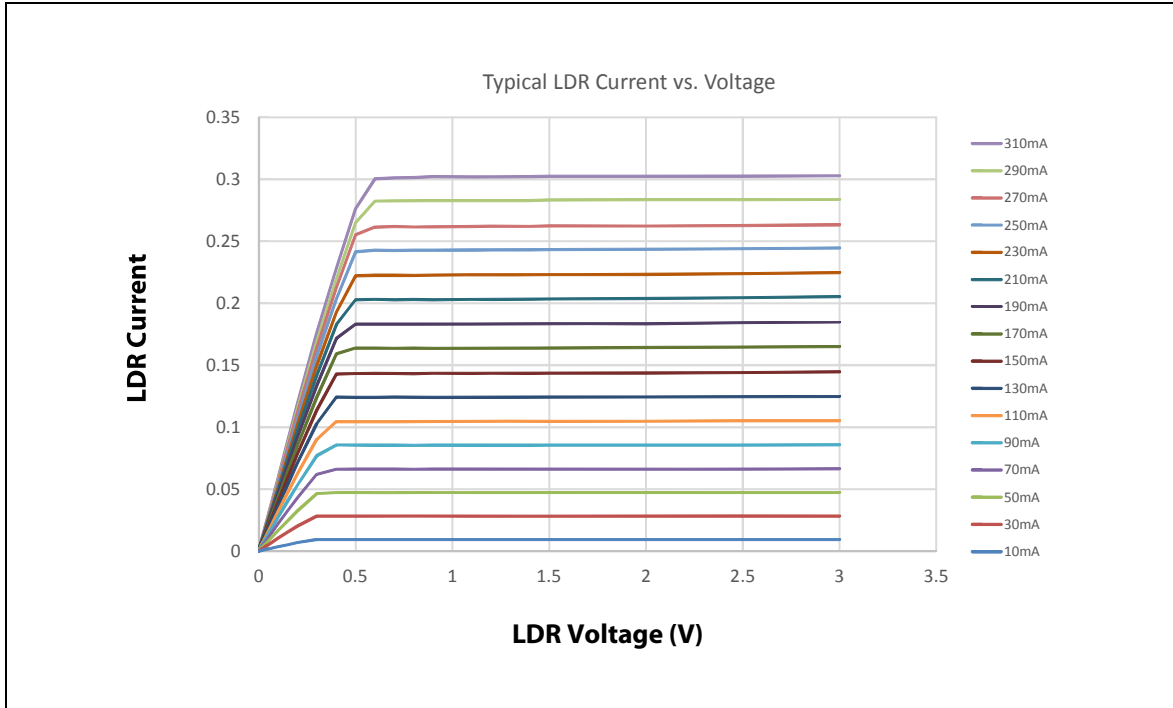

Figure 19:
Responsivity Temperature Coefficient

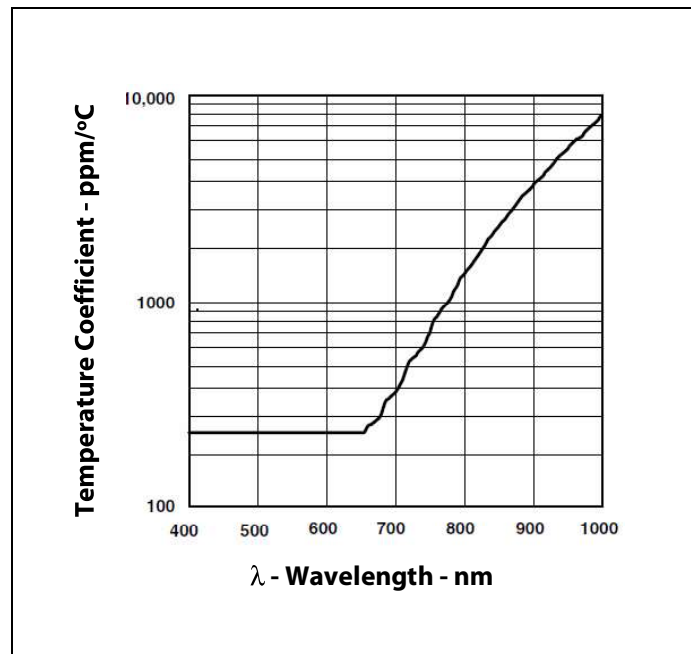

Figure 20:
Illuminance (Lux) vs. Counts (Clear Channel)

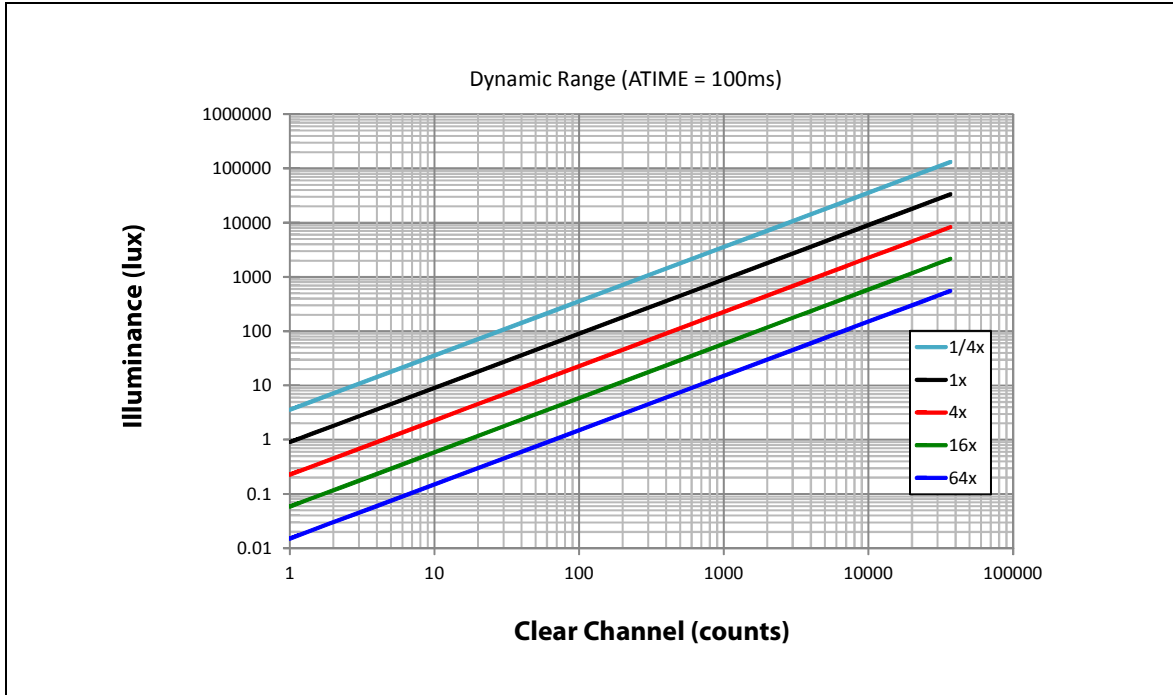
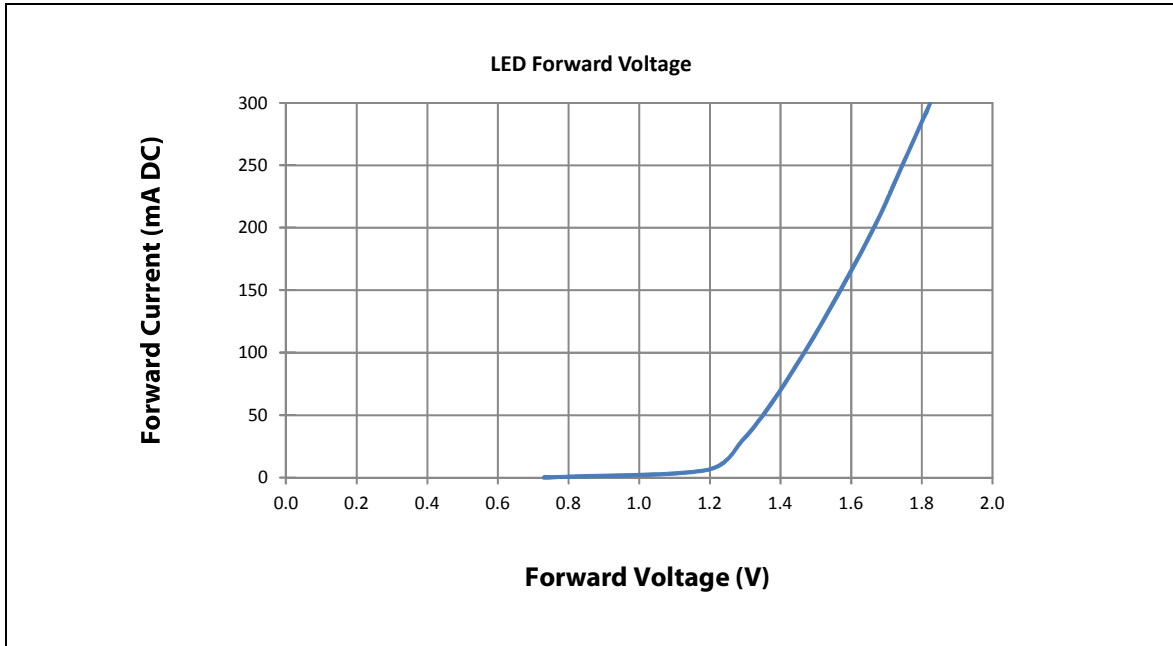

Figure 21:
950nm LED Forward Voltage vs. Current



Note(s):

1. The voltage on the LDR pin (VLEDA – VLED FORWARD) must be sufficiently large to guarantee proper operation of the regulated current sink.

Figure 22:
Gesture and Proximity Response vs. Target Distance

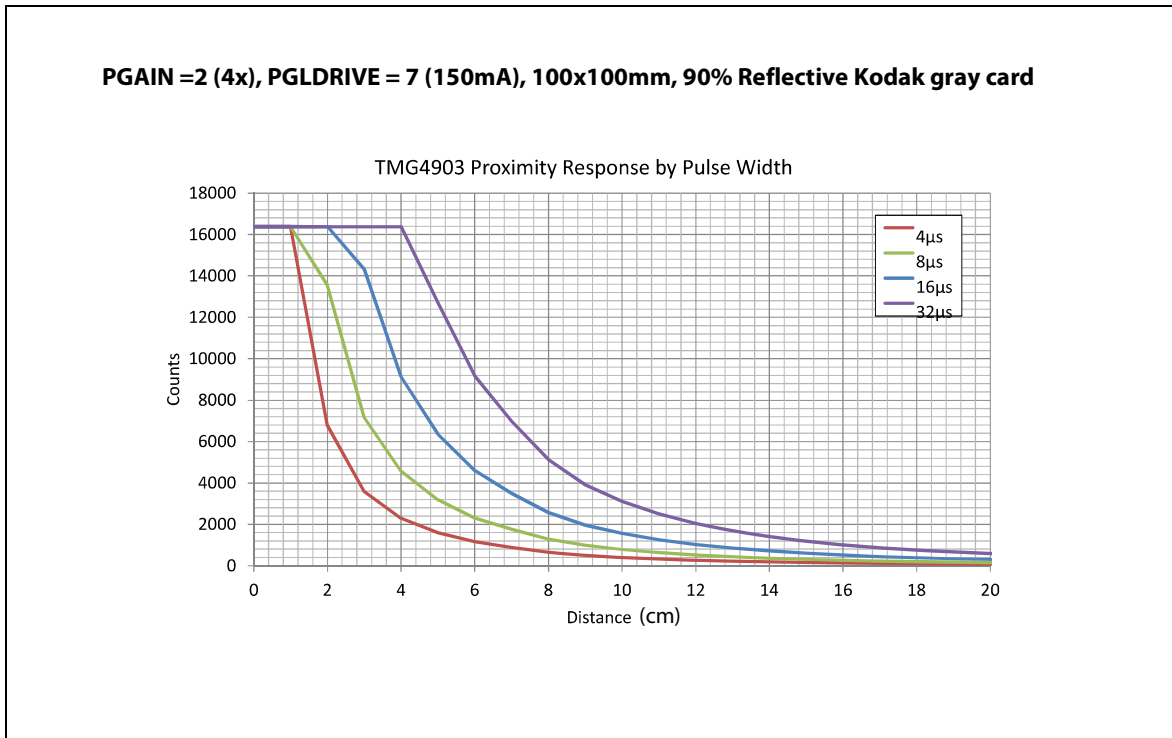

Figure 23:
Gesture Angle Response

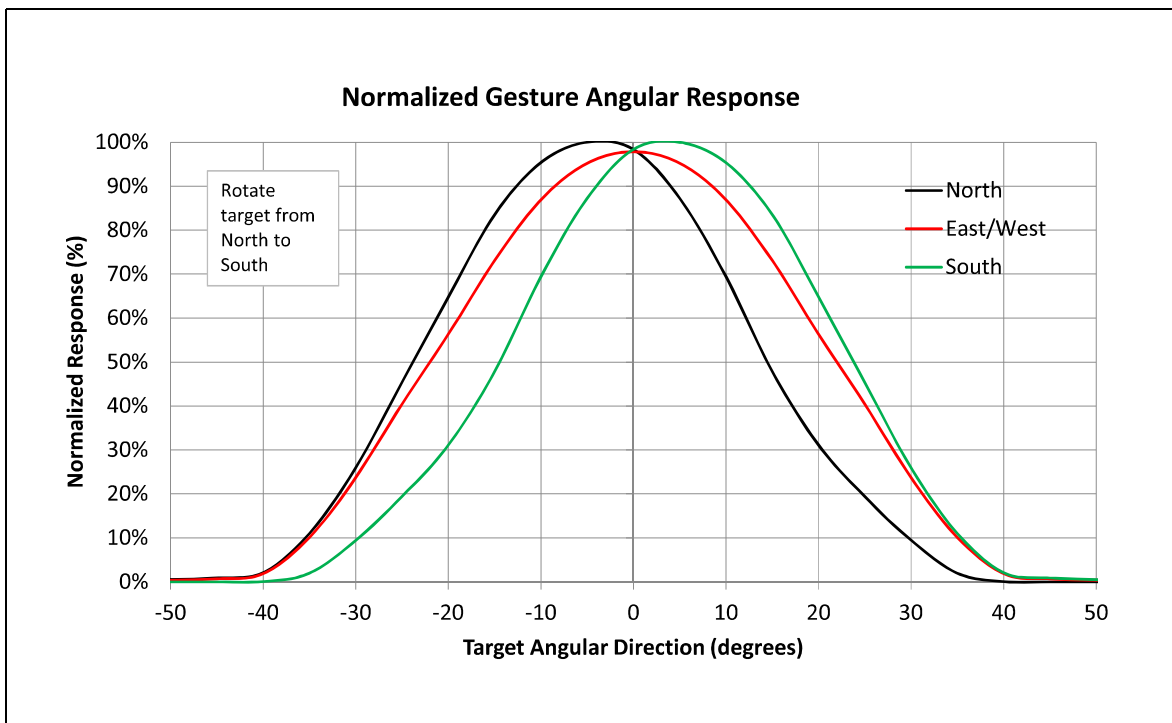
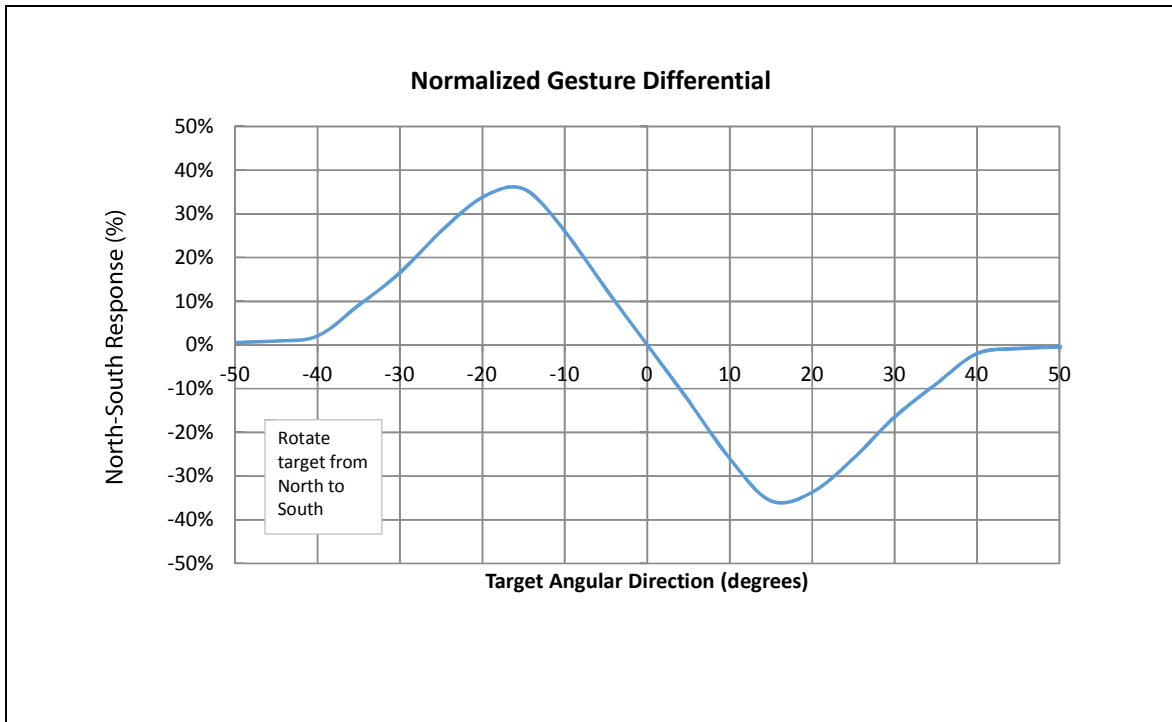

Figure 24:
Gesture Differential



Note(s):

1. The East-West Response (%) is the same vs Target Angular Direction when the target is rotated from East to West.

I²C Protocol

The device uses I²C serial communication protocol for communication. The device supports 7-bit chip addressing and both standard and full-speed clock frequency modes. Read and Write transactions comply with the standard set by Philips (now NXP).

Internal to the device, an 8-bit buffer stores the register address location of the desired byte to read or write. This buffer auto-increments upon each byte transfer and is retained between transaction events (i.e. valid even after the master issues a STOP command and the I²C bus is released). During consecutive Read transactions, the future/repeated I²C Read transaction may omit the memory address byte normally following the chip address byte; the buffer retains the last register address +1.

All 16-bit fields have a latching scheme for reading and writing. In general it is recommended to use I²C bursts whenever possible, especially in this case when accessing two bytes of one logical entity. When reading these fields, the low byte must be read first, and it triggers a 16-bit latch that stores the 16-bit field. The high byte must be read immediately afterwards. When writing to these fields, the low byte must be written first, immediately followed by the high byte. Reading or writing to these registers without following these requirements will cause errors.

I²C Write Transaction

A Write transaction consists of a START, CHIP-ADDRESSWRITE, REGISTER-ADDRESS WRITE, DATA BYTE(S), and STOP. Following each byte (9TH clock pulse) the slave places an ACKNOWLEDGE/NOT-ACKNOWLEDGE (ACK/NACK) on the bus. If NACK is transmitted by the slave, the master may issue a STOP.

I²C Read Transaction

A Read transaction consists of a START, CHIP-ADDRESSWRITE, REGISTER-ADDRESS, RESTART, CHIP-ADDRESSREAD, DATA BYTE(S), and STOP. Following all but the final byte the master places an ACK on the bus (9TH clock pulse). Termination of the Read transaction is indicated by a NACK being placed on the bus by the master, followed by STOP.

The I²C bus protocol was developed by Philips (now NXP). For a complete description of the I²C protocol, please review the NXP I²C design specification.

Figure 25:
Simplified State Diagram

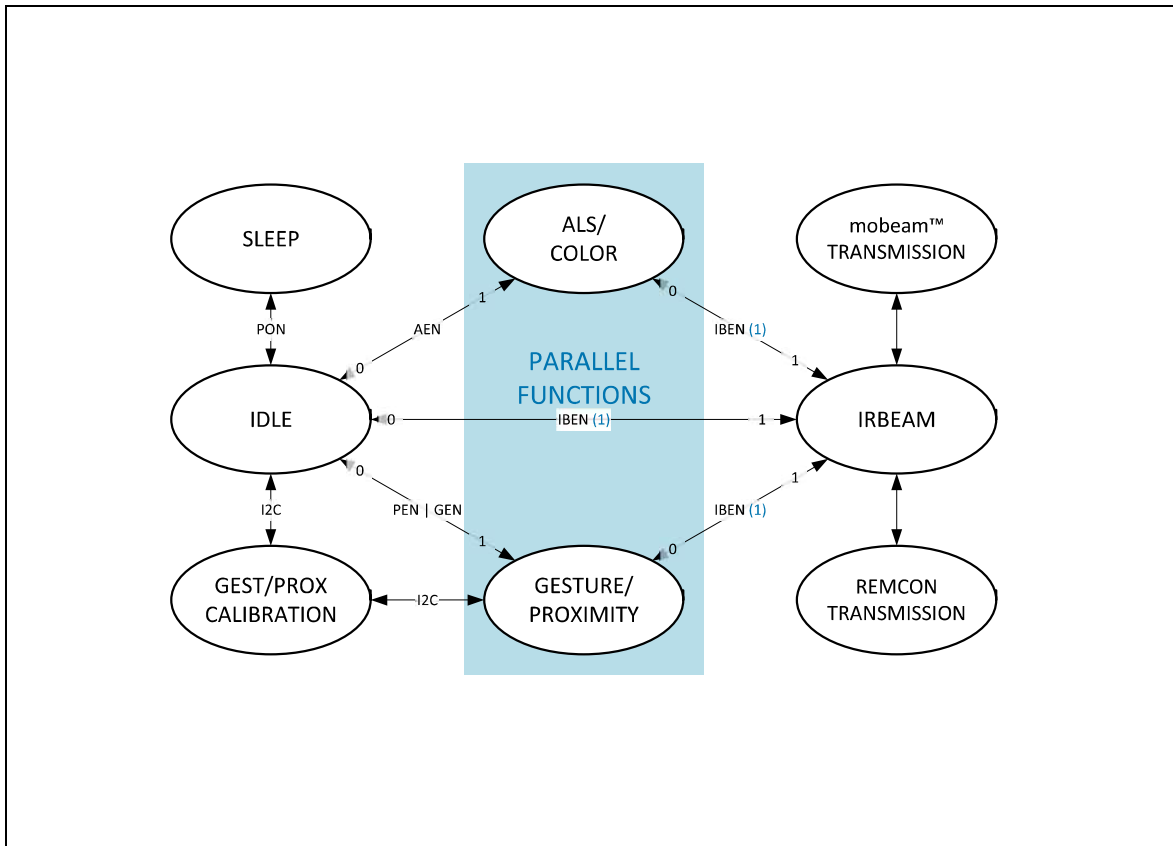
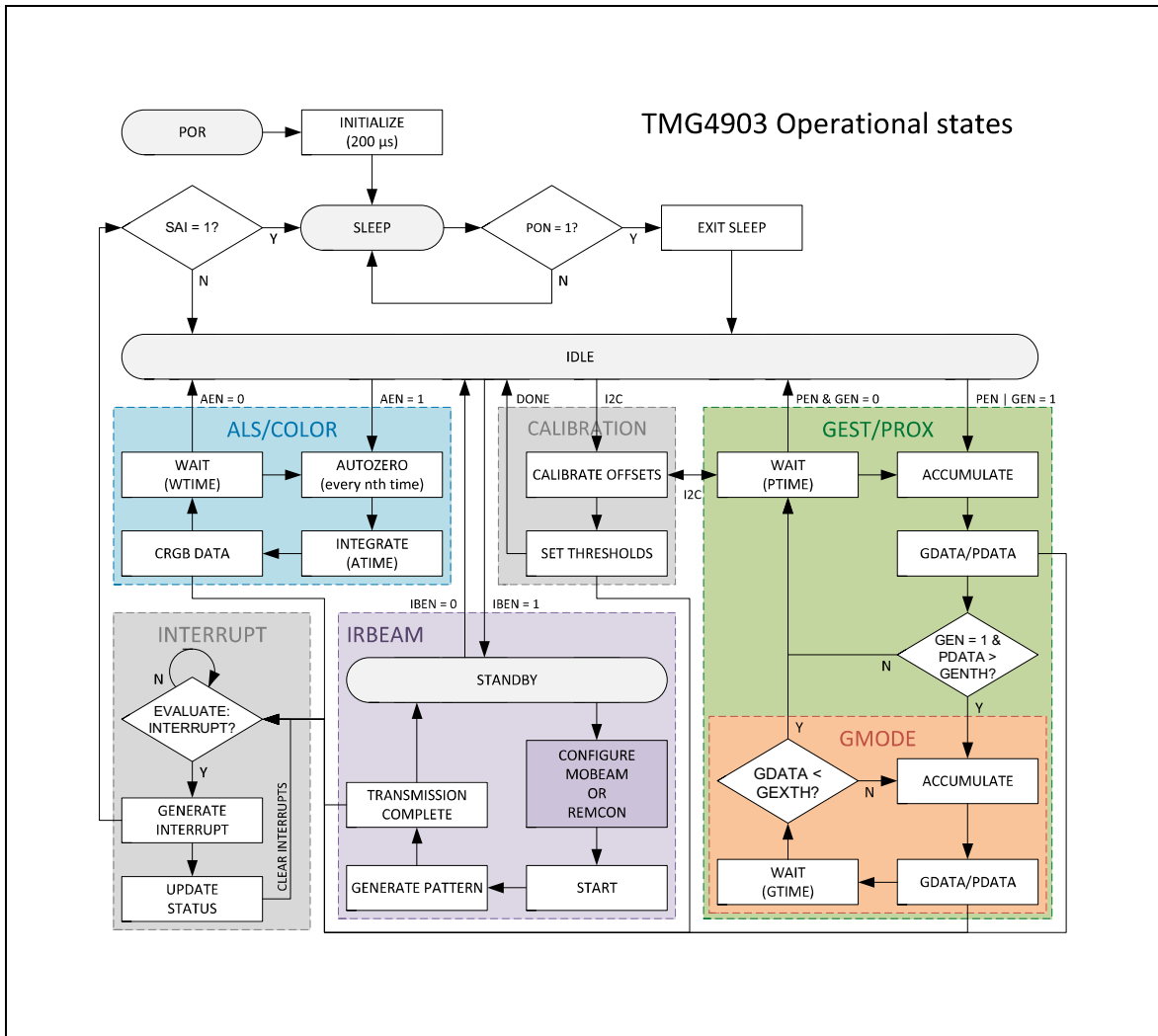

Figure 26:
Detailed State Diagram



Note(s):

1. While IRBeam is enabled (IBEN = 1), PROXIMITY is disabled automatically.

Detailed Description

Upon power-up, POR, the device initializes. During initialization (typically 200µs), the device will deterministically send NAK on I²C and cannot accept I²C transactions. All communication with the device must be delayed, and all outputs from the device must be ignored including interrupts. After initialization, the device enters the SLEEP state. In this operational state the internal oscillator and other circuitry are not active, resulting in ultra-low power consumption. If I²C transaction occurs during this state, the I²C core wake up temporarily to service the communication. Once the Power ON bit, PON, is enabled, the device enters the IDLE state in which the internal oscillator and attendant circuitry are active, but power consumption remains low. The first time the SLEEP state is exited and any functions are enabled (PEN | GEN | AEN | IBEN = 1) an EXIT SLEEP pause occurs followed by an immediate entry into the selected engines. If all functions are disabled (PEN = 0 & AEN = 0 & IBEN = 0), the device returns to the IDLE state.

As depicted in [Figure 25](#) and [Figure 26](#), the gesture/proximity and CRGB color sensing functions operate in parallel when enabled (PEN | GEN | AEN = 1). The IRBeam pattern generator takes priority when enabled (IBEN = 1). Proximity will not function, and ALS integration only occurs while IRBeam is in standby. In addition, when proximity calibration is requested, it will temporarily disable the proximity function. A simplified state diagram for each function is depicted in [Figure 26](#). Each function is individually configured (e.g. Gain, ADC integration time, wait time, persistence, thresholds, etc.).

Sleep After Interrupt Operation

If Sleep After Interrupt is enabled (SAI = 1), the state machine will enter SLEEP when non-gesture interrupts occur. However, for IRBeam and gesture, the state machine remains in these active modes to continue to support these functions. Entering SLEEP does not automatically change any of the register settings (e.g. PON bit is still high, but the normal operational state is over-ridden by SLEEP state). SLEEP state is terminated when the SAI bit is cleared.

Register Description

The device is controlled and monitored by registers accessed through the I²C serial interface. These registers provide for a variety of control functions and can be read to determine results of the ADC conversions. The register set is summarized in [Figure 27](#).

Figure 27:
Control Register Map

Address	Register Name	R/W	Register Function	Reset Value
0x00 – 0x7F	RAM	R/W	Volatile Storage for Pattern data	0x00
0x80	ENABLE	R/W	Enables states and interrupts	0x00
0x81	ATIME	R/W	ADC integration time	0xFF
0x82	PTIME	R/W	Proximity sample time	0x00
0x83	WTIME	R/W	ALS wait time	0xFF
0x84	AILTL	R/W	ALS interrupt low threshold low byte	0x00
0x85	AILTH	R/W	ALS interrupt low threshold high byte	0x00
0x86	AIHTL	R/W	ALS interrupt high threshold low byte	0x00
0x87	AIHTH	R/W	ALS interrupt high threshold high byte	0x00
0x88	PILTL	R/W	Proximity interrupt low threshold low byte	0x00
0x89	PILTH	R/W	Proximity interrupt high threshold high byte	0x00
0x8A	PIHTL	R/W	Proximity interrupt low threshold low byte	0x00
0x8B	PIHTH	R/W	Proximity interrupt high threshold high byte	0x00
0x8C	PERS	R/W	ALS & Proximity interrupt persistence filters	0x00
0x8D	CFG0	R/W	Configuration register zero	0xA0
0x8E	PGCFG0	R/W	Proximity pulse width and count	0x4F
0x8F	PGCFG1	R/W	Proximity gain and LED current	0x80
0x90	CFG1	R/W	Configuration register one	0x00
0x91	REVID	R	Revision ID	0x02
0x92	ID	R	Device ID	0xB8
0x93	STATUS	R	Device status register one	0x00
0x94	CDATAL	R	Clear ADC low data register	0x00
0x95	CDATAH	R	Clear ADC high data register	0x00
0x96	RDATAH	R	Red ADC low data register	0x00

Address	Register Name	R/W	Register Function	Reset Value
0x97	RDATAH	R	Red ADC high data register	0x00
0x98	GDATAH	R	Green ADC low data register	0x00
0x99	GDATAH	R	Green ADC high data register	0x00
0x9A	BDATAH	R	Blue ADC low data register	0x00
0x9B	BDATAH	R	Blue ADC high data register	0x00
0x9C	PDATAH	R	Proximity ADC low data register	0x00
0x9D	PDATAH	R	Proximity ADC high data register	0x00
0x9E	STATUS2	R	Additional device status	0x00
0x9F	CFG2	R/W	Configuration register two	0x04
0xA0	ICONFIG	R/W	IRBeam configuration register one	0x00
0xA1	ICONFIG2	R/W	IRBeam configuration register two	0x00
0xA2	ISNL	R/W	IRBeam symbol loops	0x00
0xA3	ISOFF	R/W	IRBeam delay between symbol loops	0x00
0xA4	IPNL	R/W	IRbeam packet loops	0x00
0xA5	IPOFF	R/W	IRBeam delay between packet loops	0x00
0xA6	IBT	R/W	IRBeam time period	0x00
0xA7	ISLEN	R/W	IRBeam symbol length	0x00
0xA8	ISTATUS	R	IRBeam status	0x00
0xA9	ISTART	R/W	IRBeam start transmission	0x00
0xAB	CFG3	R/W	Configuration register three	0x00
0xAC	CFG4	R/W	Configuration register four	0x07
0xAD	CFG5	R/W	Configuration register five	0x08
0xB0	GCFG0	R/W	Gesture configuration register zero	0x00
0xB1	GCFG1	R/W	Gesture configuration register one	0x8F
0xB2	GCFG2	R/W	Gesture configuration register two	0x80
0xB3	STATUS3	R	Status register three	0x00
0xB4	GTIME	R/W	Gesture time	0x0A
0xB5	GST_CTRL	R/W	Gesture control	0x00
0xB6	GTHR_INL	R/W	Gesture entry threshold low byte	0x00
0xB7	GTHR_INH	R/W	Gesture entry threshold high byte	0x00

Address	Register Name	R/W	Register Function	Reset Value
0xB8	GTHR_OUTL	R/W	Gesture exit threshold low byte	0x00
0xB9	GTHR_OUTH	R/W	Gesture exit threshold high byte	0x00
0xBA	GFIFO_LVL	R	Gesture FIFO entries waiting for readout	0x00
0xBB	GSTATUS	R	Gesture status	0x00
0xBC	CONTROL	R/W	Control register	0x00
0xBD	AUXID	R	Auxiliary ID	0x00
0xC0	OFFSETNL	R/W	North channel offset low byte	0x00
0xC1	OFFSETNH	R/W	North channel offset high byte	0x00
0xC2	OFFSETSLS	R/W	South channel offset low byte	0x00
0xC3	OFFSETSLSH	R/W	South channel offset high byte	0x00
0xC4	OFFSETWL	R/W	West channel offset low byte	0x00
0xC5	OFFSETWH	R/W	West channel offset high byte	0x00
0xC6	OFFSETEL	R/W	East channel offset low byte	0x00
0xC7	OFFSETEH	R/W	East channel offset high byte	0x00
0xD0	PBSLN_MEASL	R	Measured baseline low byte	0x00
0xD1	PBSLN_MEASH	R	Measured baseline high byte	0x00
0xD2	PBSLNL	R	Stored baseline low byte	0x00
0xD3	PBSLNH	R	Stored baseline high byte	0x00
0xD6	AZ_CONFIG	R/W	Configure CRGB autozero frequency	0xFF
0xD7	CALIB	R/W	Start offset calibration	0x00
0xD8	CALIBCFG0	R/W	Calibration configuration register zero	0x44
0xD9	CALIBCFG1	R/W	Calibration configuration register one	0x0C
0xDA	CALIBCFG2	R/W	Calibration configuration register two	0x20
0xDB	CALIBCFG3	R/W	Calibration configuration register three	0x10
0xDC	CALIBSTAT	R/W	Calibration status	0x00
0xDD	INTENAB	R/W	Interrupt enable	0x00
0xDE	INCLEAR	R/W	Interrupt clear	0x00
0xF8	GFIFO0L	R	Gesture FIFO North low byte	0x00
0xF9	GFIFO0H	R	Gesture FIFO North high byte	0x00
0xFA	GFIFO1L	R	Gesture FIFO South low byte	0x00

Address	Register Name	R/W	Register Function	Reset Value
0xFB	GFIFO1H	R	Gesture FIFO South high byte	0x00
0xFC	GFIFO2L	R	Gesture FIFO West low byte	0x00
0xFD	GFIFO2H	R	Gesture FIFO West high byte	0x00
0xFE	GFIFO3L	R	Gesture FIFO East low byte	0x00
0xFF	GFIFO3H	R	Gesture FIFO East high byte	0x00

Enable Register (ENABLE 0x80)

Enable has fields that power on the device and enable the functions. Before enabling any functions, all of the bits associated with each function must be set. Changing control register values while operating may result in invalid results.

Figure 28:
Enable Register

7	6	5	4	3	2	1	0
IBEN	GEN	PIEN	AIEN	WEN	PEN	AEN	PON

Field	Bits	Description
IBEN	7	IRBeam Enable. When asserted, the LED driver pin (LDR) is controlled by the IRBeam state machine. Proximity is suppressed. ALS continues in the background except when IBUSY = 1 (ISTATUS register).
GEN	6	Gesture Enable. When asserted, the gesture state machine can be activated by setting GMODE = 1 or when a proximity value is above the gesture entry threshold.
PIEN	5	Proximity Interrupt Enable. When asserted permits proximity interrupts to be generated, subject to the proximity thresholds and persistence filter.
AIEN	4	ALS Interrupt Enable. When asserted permits ALS interrupts to be generated, subject to the ALS thresholds and persistence filter.
WEN	3	Wait Enable. This bit activates the wait feature. Writing a 1 activates the wait timer. Writing a 0 disables the wait timer.
PEN	2	Proximity Enable. This bit activates the proximity function. Writing a 1 enables proximity. Writing a 0 disables proximity.
AEN	1	ALS Enable. This bit activates the ALS/Color functionality. Writing a 1 enables ALS/Color. Writing a 0 disables ALS/Color.
PON	0	Power ON. This bit activates the internal oscillator to permit the timers and ADC channels to operate. Writing a 1 activates the oscillator. Writing a 0 disables the oscillator and clears IBEN, PEN, and AEN. Only set this bit after all other registers have been initialized by the host.

ALS Integration Time Register (ATIME 0x81)

Figure 29:
ALS Integration Time Register

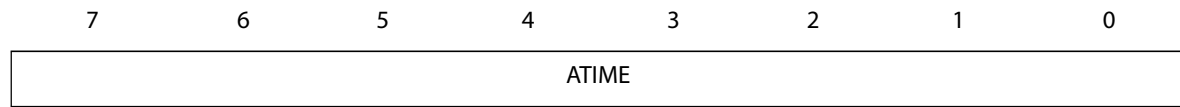

Field	Bits	Description																					
ATIME	7:0	<p>ALS Integration Time. Sets the internal integration time of ALS/Color analog to digital converters in increments of 2.78ms. The power on reset value is 0xFF. The ADC maximum count (or saturation) value depends on the integration time. It is the lesser of either: 65535 (16-bit saturation) or The result of equation: $Count_{MAX} = 1024 \times CYCLES$</p>																					
		<table border="1"> <thead> <tr> <th>VALUE</th> <th>INTEGRATION TIME</th> <th>MAX COUNTS</th> </tr> </thead> <tbody> <tr> <td>0xFF</td> <td>2.78ms</td> <td>1024</td> </tr> <tr> <td>0xF6</td> <td>27.8ms</td> <td>10240</td> </tr> <tr> <td>0xDC</td> <td>100ms</td> <td>36864</td> </tr> <tr> <td>...</td> <td>$2.78ms \times (256 - ATIME)$</td> <td>...</td> </tr> <tr> <td>0xC0</td> <td>178ms</td> <td>65535</td> </tr> <tr> <td>0x00</td> <td>711ms</td> <td>65535</td> </tr> </tbody> </table>	VALUE	INTEGRATION TIME	MAX COUNTS	0xFF	2.78ms	1024	0xF6	27.8ms	10240	0xDC	100ms	36864	...	$2.78ms \times (256 - ATIME)$...	0xC0	178ms	65535	0x00	711ms	65535
		VALUE	INTEGRATION TIME	MAX COUNTS																			
		0xFF	2.78ms	1024																			
		0xF6	27.8ms	10240																			
		0xDC	100ms	36864																			
		...	$2.78ms \times (256 - ATIME)$...																			
		0xC0	178ms	65535																			
0x00	711ms	65535																					

Proximity Sample Time Register (PTIME 0x82)

Figure 30:
Proximity Sample Time Register

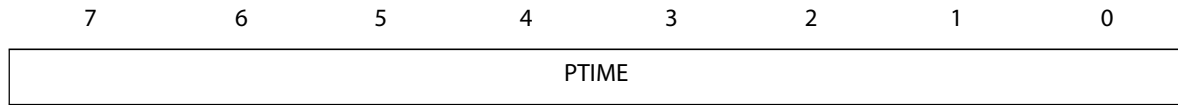

Field	Bits	Description		
PTIME	7:0	Proximity Sample Time. Sets the proximity sample rate. The power on reset value is 0x00. Proximity is executed once for each sample time.		
		VALUE	SAMPLE TIME	FREQUENCY
		0x00	2.78ms	360Hz
		0x01	5.56ms	180Hz
		0x03	11.1ms	90Hz
		0x23	100ms	10Hz
		...	<i>2.78ms X (PTIME + 1)</i>	<i>1/Proximity Sample Time</i>
		0xFF	711ms	1.41Hz

Wait Time Register (WTIME 0x83)

Figure 31:
Wait Time Register

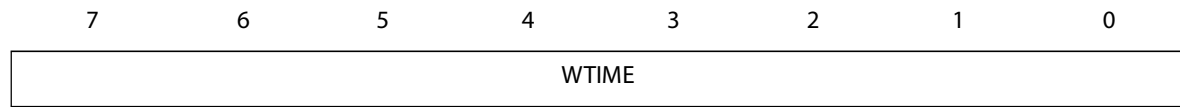

Field	Bits	Description		
WTIME	7:0	Wait Time. Sets the wait time between ALS cycles. Wait mode reduces current consumption. It is set in 2.78ms increments unless the WLONG bit is asserted in which case the wait times are 12x longer. The power on reset value is 0xFF. Wait time should be configured before AEN is asserted.		
		VALUE	WAIT TIME (WLONG=0)	WAIT TIME (WLONG=1)
		0xFF	2.78ms	0.03s
		0xDC	100ms	1.20s
		...	<i>2.78ms X (256 - WTIME)</i>	<i>33.3ms X (256 - WTIME)</i>
		0x6A	417ms	5.00s
		0x00	711ms	8.53s

ALS Interrupt Threshold Registers (0x84 – 0x87)

ALS level detection uses data generated by the Clear Channel. The ALS Interrupt Threshold registers provide 16-bit values to be used as the high and low thresholds for comparison to the 16-bit CDATA values. If AIEN is enabled and CDATA is not between AILT and AIHT for the number of consecutive samples specified in APERS an interrupt is asserted on the interrupt pin.

Figure 32:
ALS Interrupt Threshold Registers

Field	Register	Bits	Description
AILT	0x84	7:0	ALS low threshold low byte
	0x85	15:8	ALS low threshold high byte
AIHT	0x86	7:0	ALS high threshold low byte
	0x87	15:8	ALS high threshold high byte

Proximity Interrupt Threshold Registers (0x88 – 0x8B)

The Proximity Interrupt Threshold Registers set the high and low trigger points for the comparison function which generates an interrupt. If PDATA, the value generated by proximity channel, crosses from above to below the lower threshold or from below to above the upper threshold, an interrupt may be signaled to the host processor. Interrupt generation is subject to the value set in persistence filter (PPERS).

Figure 33:
Proximity Interrupt Threshold Registers

Field	Register	Bits	Description
PILT	0x88	7:0	Proximity low threshold low byte
	0x89	15:8	Proximity low threshold high byte
PIHT	0x8A	7:0	Proximity high threshold low byte
	0x8B	15:8	Proximity high threshold high byte

Interrupt Persistence Register (PERS 0x8C)

Figure 34:
Interrupt Persistence Register

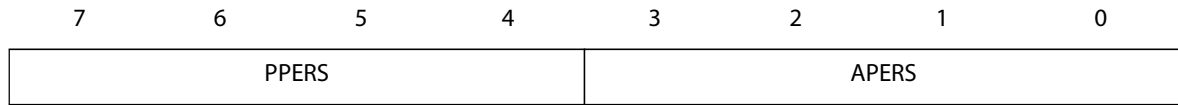

Field	Bits	Description	
PPERS	7:4	<p>Proximity Interrupt Persistence. Defines a filter for the number of consecutive occurrences that PDATA must remain outside the threshold range between PILT and PIHT before an interrupt is generated. Any sample that is inside the threshold range resets the counter to 0.</p>	
		VALUE	CONSECUTIVE OCCURENCES OUT OF RANGE
		0	Every proximity cycle generates an interrupt
		1	Generate interrupt after every occurrence.
		2	Generate interrupt after 2 occurrences.
		...	Generate interrupt after <i>PPERS</i> occurrences.
		15	Generate interrupt after 15 occurrences.
APERS	3:0	<p>ALS Interrupt Persistence. Defines a filter for the number of consecutive occurrences that CDATA must remain outside the threshold range between AILT and AIHT before an interrupt is generated. Any sample that is inside the threshold range resets the counter to 0.</p>	
		VALUE	CONSECUTIVE OCCURENCES OUT OF RANGE
		0	Every ALS cycle generates an interrupt
		1	Generate interrupt after every occurrence.
		2	Generate interrupt after 2 occurrences.
		3	Generate interrupt after 3 occurrences.
		4	Generate interrupt after 5 occurrences.
		5	Generate interrupt after 10 occurrences.
		...	Generate interrupt after $5 \times (APERS - 3)$ occurrences.
		14	Generate interrupt after 55 occurrences.
		15	Generate interrupt after 60 occurrences.

Configuration Register Zero (CFG0 0x8D)

Figure 35:
Configuration Register Zero

7	6	5	4	3	2	1	0
Reserved	LOWPOWER_IDLE	Reserved	WLONG	RAM_BANK			

Field	Bits	Description	
Reserved	7:6	Reserved.	
LOWPOWER_IDLE	5	Low Power Idle. When asserted, the device will run in a low power mode if all functions are in wait states or disabled.	
Reserved	4:3	Reserved.	
WLONG	2	Wait Long Enable. When asserted, the wait cycles are increased by a factor 12x.	
RAM_BANK	1:0	RAM Bank Selection. Specifies the RAM bank to access for IRBeam.	
		VALUE	RAM BANK ACCESS
		0	Ram Bank 0 (lower 128 bytes)
		1	Ram Bank 1 (upper 128 bytes)
		2	Access is given to the 16 words at 0xB0...0xBF.
3			

Proximity/Gesture Configuration Register Zero (PGCFG0 0x8E)

PGCFG0 has fields that set the amount of time the LED driver is sinking current during a proximity pulse and set the maximum number of pulses for each proximity sample.

Figure 36:
Proximity Configuration Register Zero

7	6	5	4	3	2	1	0
PGPULSE_LEN		PPULSE					

Field	Bits	Description	
PGPULSE_LEN	7:6	Proximity Pulse Length. Sets the LED-ON pulse width during a Proximity pulse.	
		VALUE	LED ON
		0	4 μ s
		1	8 μ s
		2	16 μ s
	3	32 μ s	
PPULSE	5:0	Proximity Pulse Count. Specifies the maximum number of Proximity pulses to be generated on LDR. The pulse count can be set between 1 and 64 pulses. The number of pulses is equal to the PPULSE value plus 1.	

Proximity/Gesture Configuration Register One (PGCFG1 0x8F)

PGCFG1 has fields that set the electrical gain of the proximity response and set the LED drive current during pulses.

Figure 37:
Proximity Configuration Register One

7	6	5	4	3	2	1	0
PGGAIN		Reserved	PGLDRIVE				Reserved

Field	Bits	Description	
PGGAIN	7:6	Proximity Gain Control.	
		VALUE	GAIN VALUE
		0	1x Gain
		1	2x Gain
		2	4x Gain
3	8x Gain		
Reserved	5	Reserved. Bit must be set to 0.	
PGLDRIVE	4:1	Proximity LED Drive Strength. Configures nominal LED current linearly in steps of 20mA (actual current depends on factory-configuration of LED drive strength).	
		VALUE	LED STRENGTH
		0	10mA
		1	30mA
		2	50mA
		...	<i>10mA + (20mA * PGLDRIVE)</i>
		14	290mA
15	310mA		
Reserved	0	Reserved. Bit must be set to 0.	

Configuration Register One (CFG1 0x90)

CFG1 has fields that enable or disable the saturation interrupts for Proximity and ALS and set the electrical gain of the ALS response.

Figure 38:
Configuration Register One

	7	6	5	4	3	2	1	0
	PGSIEN	ASIEN	Reserved				AGAIN	

Field	Bits	Description	
PGSIEN	7	Proximity Saturation Interrupt Enable. When asserted permits proximity saturation interrupts to be generated.	
ASIEN	6	ALS Saturation Interrupt Enable. When asserted permits ALS saturation interrupts to be generated.	
Reserved	5:2	Reserved. Bits must be set to 0.	
AGAIN	1:0	ALS and Color Gain Control.	
		FIELD VALUE	CRGB GAIN VALUE
		0	1x Gain
		1	4x Gain
		2	16x Gain
		3	64x Gain

Revision ID Register (REVID 0x91)

Figure 39:
Revision ID Register

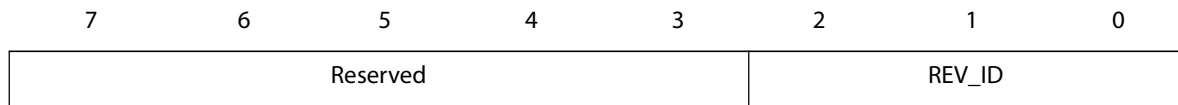

Field	Bits	Description
Reserved	7:3	Reserved. Default value is 00000.
REV_ID	2:0	Wafer die revision level. Default value is 010.

ID Register (ID 0x92)

Figure 40:
ID Register

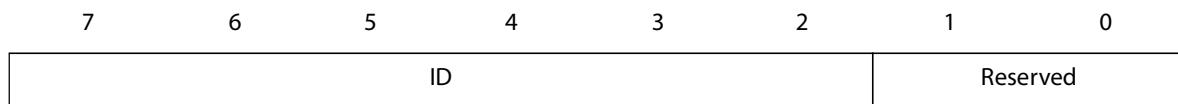

Field	Bits	Description
ID	7:2	Device Identification = 101110
Reserved	1:0	Reserved. Default value is 00.

Status Register (STATUS 0x93)

The read-only Status Register provides the status of the device.

Figure 41:
Status Register

7	6	5	4	3	2	1	0
ASAT	PGSAT	PINT	AINT	IINT	GINT	CINT	Reserved

Field	Bits	Description
ASAT	7	ALS Saturation. If ASIEN is set, indicates ALS saturation. Check the STATUS2 register to differentiate between analog or digital saturation.
PGSAT	6	Proximity/Gesture Saturation. If PGSIEN is set, indicates analog saturation during a previous proximity cycle. Check the STATUS2 register to differentiate between ambient or reflected light saturation.
PINT	5	Proximity Interrupt. If PIEN is set, indicates that a proximity detect or release event that met the programmed proximity thresholds (PILT or PIHT) and persistence (PPERS) occurred.
AINT	4	ALS Interrupt. If ASIEN is set, indicates that an ALS event that met the programmed ALS thresholds (AILT or AIHT) and persistence (APERS) occurred.
IINT	3	IRBeam Interrupt. If ILEN is set, indicates that the device is asserting an end-of-transmission interrupt after transmitting a block of data. Bit is mirrored in the ISTATUS register.
GINT	2	Gesture Interrupt. If GIEN is set, indicates that one or more gesture event conditions have been met. GINT indicates that there is data available in the FIFO buffer for readout and GFIFO_LVL is greater than GFIFOTHR or that GVALID has become asserted when GMODE transitioned to zero. The bit is reset whenever the FIFO buffer is completely emptied (read).
CINT	1	Calibration Interrupt. Indicates that either calibration is finished or that one of certain events have occurred during normal operation. If each function is enabled, CINT will be asserted if too many zeroes occur too often in a period of samples, if the proximity baseline has decreased, or if at least one offset register has been adjusted. Check the CALIBSTAT register to identify the triggering event(s).
Reserved	0	Reserved.

CRGB Data Registers (0x94 – 0x9B)

Red, green, blue, and clear data are stored as 16-bit values. The read sequence must read byte pairs (low followed by high) starting on an even address boundary (0x94, 0x96, 0x98, or 0x9A) inside the CRGB Data Register block. In addition, reading the Clear channel data low byte (0x94) latches all 8 data bytes. Reading these 8 bytes consecutively (0x94 - 0x9A) ensures that the data is concurrent.

Figure 42:
CRGB Data Registers

Field	Register	Bits	Description
CDATA	0x94	7:0	Clear channel data low byte
	0x95	15:8	Clear channel data high byte
RDATA	0x96	7:0	Red channel data low byte
	0x97	15:8	Red channel data high byte
GDATA	0x98	7:0	Green channel data low byte
	0x99	15:8	Green channel data high byte
BDATA	0x9A	7:0	Blue channel data low byte
	0x9B	15:8	Blue channel data high byte

Proximity Data Registers (0x9C – 0x9D)

Proximity data is stored as a 14-bit value (two bytes).

Proximity detection uses an Automatic Pulse Control (APC) mechanism that adjusts the number of pulses per measurement based on the magnitude of the reflected IR signal. As the magnitude of the signal increases, the number of pulses decreases. Proximity detection uses a 10-bit ADC that is extended to a 14-bit dynamic range for PDATA using the following formula:

$$PDATA = ADC_{value} \times (16 / \text{proximity pulses})$$

PDATA is the average response of the non-masked proximity photodiodes. If one or more photodiodes are masked (CFG2 register 0x9F), the proximity response will remain the same since it is an average of the active photodiodes. PDATA is therefore proportional to the reflected energy per pulse, independent of the number of pulses used.

Figure 43:
Proximity Data Register

Field	Register	Bits	Description
PDATA	0x9C	7:0	Proximity data low byte
	0x9D	13:8	Proximity data high byte

Status Register Two (STATUS2 0x9E)

Figure 44:
Status Register Two

7	6	5	4	3	2	1	0
PVALID	AVALID	Reserved	ASAT_ DIGITAL	ASAT_ ANALOG	PGSAT_ ADC	PGSAT_ REFLECTIVE	PGSAT_ AMBIENT

Field	Bits	Description
PVALID	7	Proximity Valid. Indicates that the ALS state has completed a cycle since either an assertion of PEN or the last readout of PDATA.
AVALID	6	ALS Valid. Indicates that the proximity state has completed a cycle since either an assertion of AEN or the last readout of the CDATAL data register.
Reserved	5	Reserved.
ASAT_DIGITAL	4	ALS Digital Saturation. Indicates that the maximum counter value has been reached. Maximum counter value depends on integration time set in the ATIME register.
ASAT_ANALOG	3	ALS Analog Saturation. Indicates that the intensity of ambient light has exceeded the maximum integration level for the ALS analog circuit.
PGSAT_ADC	2	Proximity/Gesture ADC Saturation. Indicates that the maximum ADC value has occurred.
PGSAT_REFLECTIVE	1	Proximity/Gesture Reflective Saturation. Indicates that the intensity of reflected light has exceeded the maximum integration level for the proximity analog circuit.
PGSAT_AMBIENT	0	Proximity/Gesture Ambient Saturation. Indicates that the intensity of ambient light has exceeded the maximum integration level for the proximity analog circuit.

Configuration Register Two (CFG2 0x9F)

Figure 45:
Configuration Register Two

7	6	5	4	3	2	1	0
PMASK_E	PMASK_W	PMASK_S	PMASK_N	AMASK	Reserved		

Field	Bits	Description
PMASK_E	7	Proximity Mask East. Writing a 1 disables the East photodiode.
PMASK_W	6	Proximity Mask West. Writing a 1 disables the West photodiode.
PMASK_S	5	Proximity Mask South. Writing a 1 disables the South photodiode.
PMASK_N	4	Proximity Mask North. Writing a 1 disables the North photodiode.
AMASK	3	ALS Mask. Writing a 1 reduces the ALS gain by a factor of the ALS photodiode pixels. Only the center 2x2 array of pixels remains enabled out of the 4x4 array. Reduces ALS sensitivity for measurement of maximum ambient light levels.
Reserved	2:0	Reserved.

IRBeam Configuration Register (ICONFIG 0xA0)

Figure 46:
IRBeam Configuration Register

7	6	5	4	3	2	1	0
Reserved		IIEN	SLEW	Reserved	ISQZT		

Field	Bits	Description	
Reserved	7:6	Reserved.	
IIEN	5	IRBeam Interrupt Enable. When asserted permits IRBeam interrupts to be generated.	
SLEW	4	Slew Rate Control. Must be set to 1. Slew rate is used to maintain LED pulse symmetry.	
Reserved	3	Reserved.	
ISQZT	2:0	IRBeam Symbol Quiet Zone Time. Defines the delay between symbols as a multiple of fundamental bit-times (IBT), calculated as follows: $t_{ISQZT} = n_{ISQZT} \times t_{IBT}$	
		VALUE	QUIET ZONE DURATION
		0	0 bit-times (Not activated)
		1	5 bit-times
		2	9 bit-times
		...	$n_{ISQZT} = 2^{ISQZT+1} + 1$
		6	129 bit-times
		7	257 bit-times

IRBeam Configuration Register Two (ICONFIG2 0xA1)

Figure 47:
IRBeam Configuration Register Two

7	6	5	4	3	2	1	0
Reserved	IINVERT	IOUTPUT	IRCDCMODE			IDUTY	

Field	Bits	Description	
Reserved	7:6	Reserved.	
IINVERT	5	IRBeam Invert. If asserted, the IRBeam output is inverted.	
IOUTPUT	4:3	IRBeam Output Pin. Define which output pin used for IRBeam.	
		VALUE	IRBEAM OUTPUT PIN
		0	LDR
		1	LDR (digital mode)
		2	INT
IRCDCMODE	2	IRBeam Remote Control DC Mode. If asserted, the pattern is transmitted in DC mode without carrier modulation. Timing is still defined by the IBT register.	
IDUTY	1:0	IRBeam Duty Cycle. Define the IRBeam duty cycle.	
		VALUE	IRBEAM DUTY CYCLE
		0	50%
		1	37.5%
		2	25%
		3	12.5%

IRBeam Symbol Looping Register (ISNL 0xA2)

Figure 48:
IRBeam Symbol Looping Register

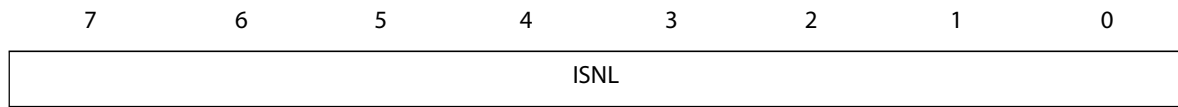

Field	Bits	Description
ISNL	7:0	<p>IRBeam Symbol Looping. Sets the number of times that a Symbol is repeated in each Packet. A Symbol is a single IRBeam data transmission. The following equation describes the number of Symbols per Packet as a function of ISNL:</p> $n_{Symbol\ Repetitions} = ISNL + 1$

IRBeam Inter-Symbol OFF Register (ISOFF 0xA3)

Figure 49:
IRBeam Inter-Symbol OFF Register



Field	Bits	Description
ISOFF	7:0	<p>Inter-Symbol Delay Time. Defines the delay (LED OFF) between Symbols within Packets, t_{ISDT}, which can range from 4.25µs to 127.75µs. The minimum permitted register value is 8. The following equation describes the time delay as a function of ISOFF and IBT:</p> $t_{ISDT} = [(2 \times ISOFF) + 1] \times t_{IBT}$

IRBeam Packet Looping Register (IPNL 0xA4)

Figure 50:
IRBeam Packet Looping Register

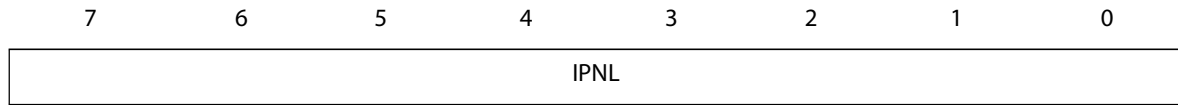

Field	Bits	Description
IPNL	7:0	<p>IRBeam Packet Looping. Sets the number of times that a Packet is repeated. Each packet consists of repeated transmission of a Symbol. The following equation describes the number of Packet repetitions as a function of IPNL:</p> $n_{Packet\ Repetitions} = IPNL + 1$

IRBeam Inter-Packet OFF Register (IPOFF 0xA5)

Figure 51:
IRBeam Inter-Packet OFF Register



Field	Bits	Description
IPOFF	7:0	<p>Inter-Packet Delay Time. Defines the delay (LED OFF) between Packet repetitions, t_{IPDT}, which can range from 10μs to 255.25μs. The minimum permitted register value is 8. The following equation describes the time delay as a function of IPOFF and IBT:</p> $t_{SDT} = [(2 \times IPOFF) + 1] \times t_{IBT}$

IRBeam Bit Time Register (IBT 0xA6)

Figure 52:
IRBeam Bit Time Register

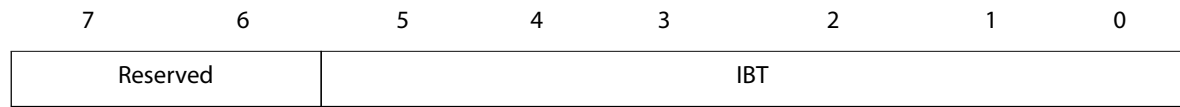

Field	Bits	Description
Reserved	7:6	Reserved.
IBT	5:0	<p>IRBeam Bit Time. Defines the fundamental IRBeam bit-time, t_{IBT}, which can range from 0.25µs to 64µs. The IRBeam bit time is set by the following equation:</p> $t_{IBT} = (IBT + 1) \times 0.25\mu s$

IRBeam Symbol Length Register (ISLEN 0xA7)

Figure 53:
IRBeam Symbol Length Register

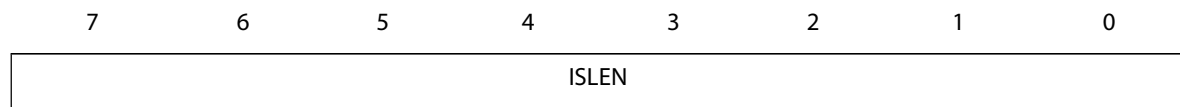

Field	Bits	Description
ISLEN	7:0	<p>IRBeam Symbol Length. Defines the length of the IRBeam Symbol in bytes. The minimum length is 2 bytes, meaning the minimum register value is 1. The following equation describes the length of the Symbol in bytes:</p> $l_{Symbol} = ISLEN + 1$

IRBeam Status Register (ISTATUS 0xA8)

Figure 54:
IRBeam Status Register

7	6	5	4	3	2	1	0
Reserved						IINT	IBUSY

Field	Bits	Description
Reserved	7:2	Reserved.
IINT	1	IRBeam Interrupt. If I IEN is set, indicates that the device is asserting an end-of-transmission interrupt after transmitting a block of data. Bit is mirrored in the STATUS register.
IBUSY	0	IRBeam Busy. Indicates an IRBeam transmission is in progress.

IRBeam Start Register (ISTART 0xA9)

Figure 55:
IRBeam Start Register

7	6	5	4	3	2	1	0
Reserved						ISTARTREMCON	ISTARTMOBEAM

Field	Bits	Description
Reserved	7:2	Reserved.
ISTARTREMCON	1	IRBeam Start Remote Control. Write 1 to start the remote control machine, executing from address 0. Transmission can be stopped by writing a 0 to this bit.
ISTARTMOBEAM	0	IRBeam Start mobeam. Write 1 to start a mobeam transmission. Transmission can be stopped by writing a 0 to this bit.

Configuration Register Three (CFG3 0xAB)

Figure 56:
Configuration Register Three

7	6	5	4	3	2	1	0
Reserved	LTF_USEPROX	Reserved	SAI	Reserved			

Field	Bits	Description			
Reserved	7	Reserved.			
LTF_USEPROX	6	Use Proximity Photodiodes for ALS Measurement. Connects the IR-sensitive proximity/gesture photodiodes to the ALS engine in order to collect ALS data in the IR band. The data registers contain the following channel data depending on the LTF_USEPROX setting.			
		16-bit Output Registers	LTF_USEPROX		
		High	Low	0	1
		0x95	0x94	Clear	North
		0x97	0x96	Red	South
		0x99	0x98	Green	West
		0x9B	0x9A	Blue	East
Reserved	5	Reserved.			
SAI	4	Sleep After Interrupt. Powers down the device at the end of a proximity/ALS cycle if an interrupt has been generated. Note that SAI does not modify any register bits directly, it rather uses the interrupt signal to turn off the oscillator. The only way to "wake up" the device from SAI-sleep is by clearing the SAI_ACTIVE flag.			
		PON	SAI	INT (Low Active)	Oscillator
		0			Off
		1	0		On
		1	1	1	On
1	1	0	Off (sleep after interrupt)		
Reserved	3:0	Reserved.			

Configuration Register Four (CFG4 0xAC)

Figure 57:
Configuration Register Four

7	6	5	4	3	2	1	0
ALS_INT_DIRECT	ALS_INT_DIRECT_GPIO	PROX_INT_DIRECT	PROX_INT_DIRECT_GPIO	Reserved			

Field	Bits	Description
ALS_INT_DIRECT	7	ALS Interrupt Direct. If asserted, then the INT pin shows the ALS state directly and it is not necessary to clear the interrupt. If the CLEAR data exits the threshold range from within, the INT pin is asserted. The interrupt pin is de-asserted when the CLEAR data re-enters the threshold range. As long as the CLEAR data is within the thresholds, the INT pin is not asserted.
ALS_INT_DIRECT_GPIO	6	ALS Interrupt Direct on GPIO Pin. If asserted, the GPIO pin shows the ALS interrupt state directly instead of the INT pin. This function operates in the same manner otherwise as ALS_INT_DIRECT.
PROX_INT_DIRECT	5	Proximity Interrupt Direct. If asserted, then the INT pin shows the proximity state directly and it is not necessary to clear the interrupt. If PDATA crosses the upper threshold from below, the INT pin is asserted. The interrupt pin is only de-asserted when PDATA crosses the lower threshold from above. As long as PDATA is below the lower threshold, the INT pin is not asserted.
PROX_INT_DIRECT_GPIO	4	Proximity Interrupt Direct on GPIO Pin. If asserted, the GPIO pin shows the proximity interrupt state directly instead of the INT pin. This function operates in the same manner otherwise as PROX_INT_DIRECT.
Reserved	3:0	Reserved.

Configuration Register Five (CFG5 0xAD)

Figure 58:
Configuration Register Five

	7	6	5	4	3	2	1	0
	Reserved	LONG_LTFSTOP_ DISCARD_ALS	Reserved	DISABLE_IR_ CORRECTION	PROX_FILTER_ DOWNSAMPLE	PROX_FILTER_ SIZE	PROX_ FILTER	

Field	Bits	Description	
Reserved	7:6	Reserved.	
LONG_LTFSTOP_DISCARD_ALS	5	Long Disruption Discard ALS. Aborts ALS integration that is disrupted if the gesture state is entered (sensor field of view is obstructed) or an IRBeam transmission is executed (long disruption while LED is pulsed for an extended duration). Immediately after gesture mode is exited or IRBeam transmission is complete, a new ALS integration is started. When restarting ALS, this function ignores wait configuration, which may cause more ALS measurements to occur than expected.	
Reserved	4	Reserved.	
DISABLE_IR_CORRECTION	3	Disable IR Correction. Default is 1. If bit is 0, then calculate $IR = (R+G+B-C)/2$ and store $R' = R-IR$, G' , B' , and C' in the color DATA registers.	
PROX_FILTER_DOWNSAMPLE	2	Proximity Filter Downsample. If PROX_FILTER = 1, then, if asserted, PDATA and proximity interrupt check are performed only every n proximity samples. If not asserted, then proximity filtering uses a moving window: PDATA is updated every cycle and proximity interrupt is checked every cycle.	
PROX_FILTER_SIZE	1	Proximity Filter Size. Determines the number of consecutive proximity samples to average to filter out noise.	
		VALUE	FILTER
		0	2 samples
PROX_FILTER	0	Proximity Filter. If asserted, enables proximity filter functionality. Depending on PROX_FILTER_SIZE, 2 or 4 consecutive proximity samples are averaged.	

Gesture Configuration Register Zero (GCFG0 0xB0)

GCFG0 has fields that affect the exit of gesture mode, GMODE.

Figure 59:
Gesture Configuration Register Zero

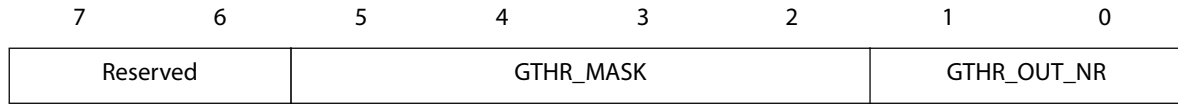

Field	Bits	Description	
Reserved	7:6	Reserved.	
GTHR_MASK	5:2	Gesture Exit Mask. Controls which gesture channels will be compared to GTHR_OUT to exit gesture mode, GMODE.	
		BIT	EXIT MASK
		5	Ignore E when exiting GMODE.
		4	Ignore W when exiting GMODE.
		3	Ignore S when exiting GMODE.
GTHR_OUT_NR	1:0	Gesture Exit Persistence. Defines how many consecutive times the gesture channel data must be below the gesture exit threshold, GTHR_OUT, for the device to exit gesture mode, GMODE.	
		VALUE	PERSISTENCE
		0	Exit after first occurrence.
		1	Exit after 2 consecutive occurrences.
		2	Exit after 4 consecutive occurrences.
3	Exit after 8 consecutive occurrences.		

Gesture Configuration Register One (GCFG1 0xB1)

Figure 60:
Gesture Configuration Register One

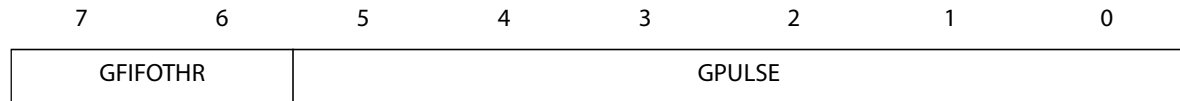

Field	Bits	Description	
GFIFOTHR	7:6	Gesture FIFO Threshold. Defines the FIFO Level, the number of NSWE datasets, required to generate an interrupt (if enabled).	
		VALUE	FIFO LEVEL FOR INTERRUPT
		0	1
		1	4
		2	8
3	16		
GPULSE	5:0	Maximum Gesture Pulse Count. Specifies the maximum number of pulses to be generated for each gesture dataset. The maximum number of pulses is calculated as follows:	
		$n_{Pulses} = GPULSE + 1$	

Gesture Configuration Register Two (GCFG2 0xB2)

Figure 61:
Gesture Configuration Register Two

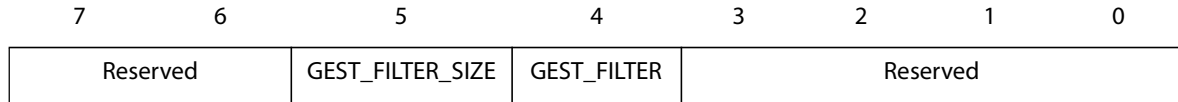

Field	Bits	Description	
Reserved	7:6	Reserved.	
GEST_FILTER_SIZE	5	Proximity Filter Size. Determines the number of consecutive gesture samples to average to filter out noise.	
		VALUE	FILTER
		0	2 samples
		1	4 samples
GEST_FILTER	4	Gesture Filter. If asserted, enables gesture filter functionality. Depending on GEST_FILTER_SIZE, 2 or 4 consecutive gesture samples are averaged. A moving window is used and gesture data is added to the buffer at every cycle.	
Reserved	3:0	Reserved.	

Status Register Three (STATUS3 0xB3)

Figure 62:
Status Register Three

7	6	5	4	3	2	1	0
Reserved						SAI_ACTIVE	Reserved

Field	Bits	Description
Reserved	7:2	Reserved.
SAI_ACTIVE	1	Sleep-After-Interrupt Active. If SAI is set, indicates that the oscillator has been stopped and the device is in sleep after an interrupt. SAI_ACTIVE must be cleared (CONTROL 0xBC[0]: CLEAR_SAI_ACTIVE) to clear SAI and resume chip operation.
Reserved	0	Reserved.

Gesture Sample Time Register (GTIME 0xB4)

Figure 63:
Gesture Sample Time Register

7	6	5	4	3	2	1	0
GTIME							

Field	Bits	Description	
GTIME	7:0	Gesture Sample Time. Sets the gesture sample rate while in gesture mode, GMODE. The power on reset value is 0x0A. Gesture data is collected once for each sample time. There is a minimum GTIME that must be configured that depends on the GPULSE and PGPULSE_LEN settings. The maximum GPULSE and PGPULSE_LEN settings for the default GTIME (0x0A) are GPULSE = 15 (16 pulses) and PGPULSE_LEN = 1 (8μs). Contact technical support for more information.	
		VALUE	SAMPLE
		0x00	88μs
		0x01	176μs
		0x0A	968μs
		0x70	9.9ms
		...	$88\mu s \times (GTIME + 1)$
		0xFF	22.5ms

Gesture Control Register (GST_CTRL 0xB5)

Figure 64:
Gesture Control Register

7	6	5	4	3	2	1	0
Reserved						GIEN	GMODE

Field	Bits	Description
Reserved	7:2	Reserved.
GIEN	1	Gesture Interrupt Enable. When asserted permits all gesture-related interrupts to occur. The first gesture interrupt is subject to GFIFOTHR.
GMODE	0	Gesture Mode. Reports if the device is in gesture mode. In gesture mode, GTIME sets the sample rate of the proximity/gesture state machine, and datasets are added to the FIFO buffer. Writing 1 to this bit forces the device to enter gesture mode (as if GTHR_IN has been exceeded). Writing a 0 to this bit causes exit of gesture when current analog conversion has finished (as if all gesture data is below GTHR_OUT).

Gesture Threshold Registers (0xB6 – 0xB9)

PDATA is compared to GTHR_IN if GEN = 1. If PDATA is greater than GTHR_IN, the device enters gesture mode (GMODE). Once in GMODE, the gesture data from each channel is compared to GTHR_OUT to determine when the device should exit GMODE. The criteria for exiting GMODE are user-configured. The proximity persistence filter, PERS, is not used to determine gesture state machine entry.

Figure 65:
Gesture Threshold Registers

Field	Register	Bits	Description
GTHR_IN	0xB6	7:0	Gesture entry threshold low byte
	0xB7	15:8	Gesture entry threshold high byte
GTHR_OUT	0xB8	7:0	Gesture exit threshold low byte
	0xB9	15:8	Gesture exit threshold high byte

Gesture FIFO Buffer Level Register (GFIFO_LVL 0xBA)

Figure 66:
Gesture FIFO Buffer Level Register

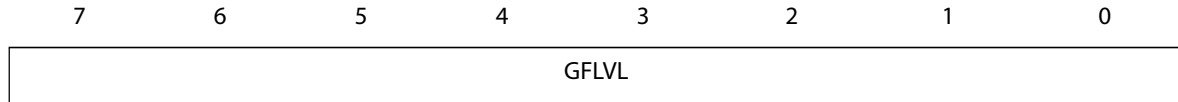

Field	Bits	Description
GFIFO_LVL	7:0	Gesture FIFO Buffer Level. Indicates the number of unread NSWE datasets in the FIFO buffer.

Gesture Status Register (GSTATUS 0xBB)

Figure 67:
Gesture Status Register

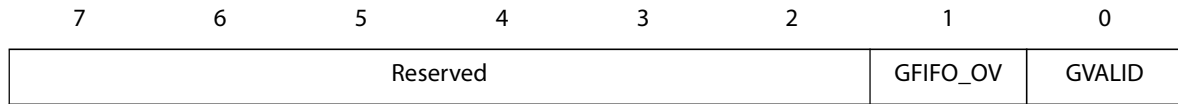

Field	Bits	Description
Reserved	7:2	Reserved.
GFIFO_OV	1	Gesture FIFO Overflow. Indicates that the FIFO buffer has been filled to capacity and data may be lost.
GVALID	0	Gesture FIFO Data. Indicates when GFIFO_LVL has exceeded GFIFOTHR. If enabled, a gesture interrupt (GINT) is asserted at this time. GINT clears as soon GFIFO_LVL = 0, but GVALID only clears after the gesture event is over when GFIFO_LVL = 0 and GMODE = 0.

Control Register (CONTROL 0xBC)

Figure 68:
Control Register

7	6	5	4	3	2	1	0
Reserved							SAI_ACTIVE_CLEAR

Field	Bits	Description
Reserved	7:1	Reserved.
SAI_ACTIVE_CLEAR	0	Sleep-After-Interrupt Active Clear. If SAI is set and SAI_ACTIVE is true (an Interrupt has occurred), asserting this pin clears the SAI_ACTIVE flag and restarts the device oscillator to resume chip operation if functions are enabled.

Auxiliary ID Register (AUXID 0xBD)

Figure 69:
Auxiliary ID Register

7	6	5	4	3	2	1	0
Reserved				AUXID			

Field	Bits	Description
Reserved	7:4	Reserved.
AUXID	3:0	Auxiliary ID. Value is 0000.

Proximity/Gesture Offset Registers (0xC0 – 0xC7)

Proximity/gesture offset values have a range of ± 255 and are expressed as 9-bit two's-complement values. Do not program values outside of this range. Only the lower 9 bits are significant, but the high byte must only be programmed with values of 0x00 (indicates that the low byte has a positive value) or 0xFF (indicates that the low byte has a negative value).

Figure 70:
Proximity/Gesture Offset Registers

Field	Register	Bits	Description
OFFSETN	0xC0	7:0	North channel offset low byte
	0xC1	15:8	North channel offset high byte
OFFSETS	0xC2	7:0	South channel offset low byte
	0xC3	15:8	South channel offset high byte
OFFSETW	0xC4	7:0	West channel offset low byte
	0xC5	15:8	West channel offset high byte
OFFSETE	0xC6	7:0	East channel offset low byte
	0xC7	15:8	East channel offset high byte

Proximity/Gesture Baseline Registers (0xD0 – 0xD3)

After proximity/gesture calibration is complete, the user may define a number of consecutive proximity cycles for which PDATA is averaged. The number of consecutive PDATA cycles to be averaged is defined by PXDCAVG_BASELINE_WINDOW (0xD9[2:0]). Averaging will repeat after every window of PDATA cycles. The latest averaged result is stored in the PBSLN_MEAS field.

The second proximity baseline field, PBSLN, is first updated at the end of proximity/gesture calibration. This value does not change unless the user sets PXDCAVG_AUTO_BASELINE (0xD9[3]) to 1. If asserted, PBSLN will be updated with the value of PBSLN_MEAS whenever PBSLN_MEAS is less than PBSLN. In addition, a multiple of PBSLN is used at the end of the calibration routine to set the gesture entry and exit thresholds if the user sets PXDCAVG_AUTO_GTHR field (0xD9[7]) to 1. The multiplication factor for setting the entry and exit thresholds is user-defined in the AUTO_GTHR_IN_MULT (0xDA[3:0]).

Figure 71:
Proximity/Gesture Baseline Registers

Field	Register	Bits	Description
PBSLN_MEAS	0xD0	7:0	Measured baseline low byte
	0xD1	15:8	Measured baseline high byte
PBSLN	0xD2	7:0	Stored baseline low byte
	0xD3	15:8	Stored baseline high byte

Autozero Configuration Register (AZ_CONFIG 0xD6)

Figure 72:
Autozero Configuration Register

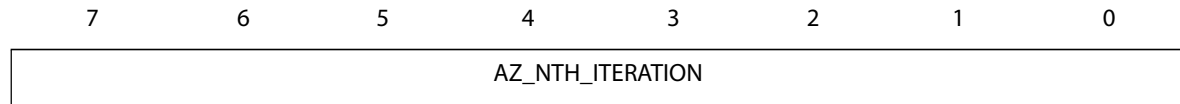

Field	Bits	Description	
AZ_NTH_ITERATION	7:0	ALS Autozero Frequency. Sets the frequency at which the device performs autozero of the ALS pulse counter.	
		VALUE	AUTOZERO FREQUENCY
		0	Never
		1	Every cycle
		2	Every 2 cycles
		...	Every (AZ_NTH_ITERATION) cycles
		253	Every 253 cycles
		254	Every 254 cycles
		255	Only once (before 1 st cycle)

Calibration Register (CALIB 0xD7)

Figure 73:
Calibration Register

7	6	5	4	3	2	1	0
Reserved							START_OFFSET_CALIB

Field	Bits	Description
Reserved	7:1	Reserved.
START_OFFSET_CALIB	0	Start Offset Calibration. Starts the proximity/gesture offset register calibration routine. Results are stored in the Proximity/Gesture Offset Registers (0xC0 – 0xC7). The CALIB_FINISHED flag is asserted when calibration is complete and an interrupt (CINT) is asserted if CIEN is set. Calibration can be stopped by writing a 0 to this field.

Calibration Configuration Register Zero (CALIBCFG0 0xD8)

Figure 74:
Calibration Configuration Register Zero

7	6	5	4	3	2	1	0
Reserved	DCAVG_ AUTO_OFFSET_ ADJUST	Reserved	ELECTRICAL_ CALIBRATION	BINSRCH_ SKIP	DCAVG_ITERATIONS		

Field	Bits	Description
Reserved	7	Reserved.
DCAVG_AUTO_OFFSET_ADJUST	6	DC Averaging Auto Offset Adjust. If set, then during DC averaging, whenever an ADC measurement is zero, the appropriate offset register will be decreased and the OFFSET_ADJUSTED flag is set. Note also that DC averaging is not automatically restarted when this happens, so the calculated baseline might be wrong. Software could restart averaging in this case.
Reserved	5	Reserved.
ELECTRICAL_CALIBRATION	4	Enable Electrical Calibration. When asserted the calibration routine will perform an internal electrical calibration to adjust the proximity offset registers to remove electrical crosstalk – there is no optical response at all for this routine. When not asserted, calibration will measure both optical and electrical crosstalk during calibration.
BINSRCH_SKIP	3	Binary Search Skip. When asserted the calibration routine will skip the binary search step. It is useful if zeroes are detected during the DC averaging process to manually reset the baseline and reduce the likelihood of zero counts.

Field	Bits	Description														
DCAVG_ITERATIONS	2:0	<p>DC Averaging Iterations. Sets the number of proximity results during calibration that are averaged after the binary search is complete. During this period, whenever a result is zero, the appropriate offset register is automatically decremented. The default value is 4 (16 iterations).</p>														
		<table border="1"> <thead> <tr> <th>VALUE</th> <th>SAMPLES</th> </tr> </thead> <tbody> <tr> <td>0</td> <td>Skip</td> </tr> <tr> <td>1</td> <td>2</td> </tr> <tr> <td>2</td> <td>4</td> </tr> <tr> <td>...</td> <td>$n_{Iterations} = 2^{DCAVG_ITERATIONS}$</td> </tr> <tr> <td>6</td> <td>64</td> </tr> <tr> <td>7</td> <td>128</td> </tr> </tbody> </table>	VALUE	SAMPLES	0	Skip	1	2	2	4	...	$n_{Iterations} = 2^{DCAVG_ITERATIONS}$	6	64	7	128
		VALUE	SAMPLES													
		0	Skip													
		1	2													
		2	4													
		...	$n_{Iterations} = 2^{DCAVG_ITERATIONS}$													
		6	64													
7	128															
0	Skip															
1	2															
2	4															
...	$n_{Iterations} = 2^{DCAVG_ITERATIONS}$															
6	64															
7	128															

Calibration Configuration Register One (CALIBCFG1 0xD9)

Figure 75:
Calibration Configuration Register One

7	6	5	4	3	2	1	0
PXDCAVG_AUTO_GTHR	PROX_AUTO_OFFSET_ADJUST	Reserved		PXDCAVG_AUTO_BASELINE	PXDCAVG_BASELINE_WINDOW		

Field	Bits	Description	
PXDCAVG_AUTO_GTHR	7	Proximity Automatic Thresholds. When asserted, GTHR_IN and GTHR_OUT are automatically written with a multiple of the PBSLN every time PBSLN changes. The multiplication factor is set in AUTO_GTHR_IN_MULT. PBSLN can only change if PXDCAVG_AUTO_BASELINE is asserted and PBSLN_MEAS is less than PBSLN.	
PROX_AUTO_OFFSET_ADJUST	6	Proximity Auto Offset Adjust. If set, then during proximity/gesture mode, whenever an ADC measurement is zero, the appropriate offset register will be decreased. Will set the OFFSET_ADJUSTED flag if it happens.	
Reserved	5:4	Reserved.	
PXDCAVG_AUTO_BASELINE	3	Proximity Automatic Baseline. When asserted, PBSLN_MEAS is written to PBSLN whenever PBSLN_MEAS is less than PBSLN. When this happens, the BASELINE_ADJUSTED flag is raised. The default value is 1.	
PXDCAVG_BASELINE_WINDOW	2:0	Prox Baseline Averaging Window. Sets the number of proximity samples averaged to calculate PBSLN_MEAS, which is updated at the end of each window. The default value is 16 samples.	
		VALUE	SAMPLES
		0	Skip
		1	2
		2	4
		...	$n_{Iterations} = 2^{PXDCAVG_BASELINE_WINDOW}$
		6	64
		7	128

Calibration Configuration Register Two (CALIBCFG2 0xDA)

Figure 76:
Calibration Configuration Register Two

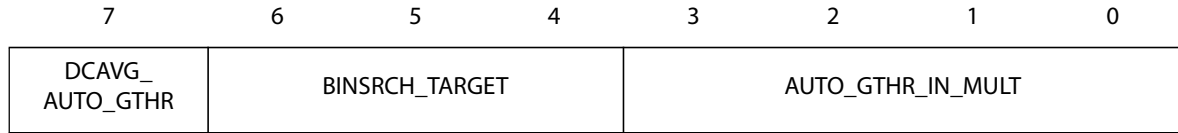

Field	Bits	Description														
DCAVG_AUTO_GTHR	7	DC Averaging Automatic Thresholds. When asserted, GTHR_IN and GTHR_OUT are automatically written with a multiple of the PBSLN at the end of the calibration routine. The multiplication factor is set in AUTO_GTHR_IN_MULT.														
BINSRCH_TARGET	6:4	<p>Binary Search Target. Sets the ADC target for proximity/gesture calibration. The default value is 2.</p> <table border="1" style="width: 100%; border-collapse: collapse;"> <thead> <tr> <th style="width: 20%;">VALUE</th> <th style="width: 80%;">SEARCH TARGET</th> </tr> </thead> <tbody> <tr><td style="text-align: center;">0</td><td style="text-align: center;">0</td></tr> <tr><td style="text-align: center;">1</td><td style="text-align: center;">1</td></tr> <tr><td style="text-align: center;">2</td><td style="text-align: center;">3</td></tr> <tr><td style="text-align: center;">...</td><td style="text-align: center;">$Target_{BINSRCH} = 2^{BINSRCH_TARGET} - 1$</td></tr> <tr><td style="text-align: center;">6</td><td style="text-align: center;">63</td></tr> <tr><td style="text-align: center;">7</td><td style="text-align: center;">127</td></tr> </tbody> </table>	VALUE	SEARCH TARGET	0	0	1	1	2	3	...	$Target_{BINSRCH} = 2^{BINSRCH_TARGET} - 1$	6	63	7	127
VALUE	SEARCH TARGET															
0	0															
1	1															
2	3															
...	$Target_{BINSRCH} = 2^{BINSRCH_TARGET} - 1$															
6	63															
7	127															
AUTO_GTHR_IN_MULT	3:0	<p>Automatic Gesture Threshold Multiplier. Sets the multiplication factor used if the gesture entry and exit thresholds are automatically calculated as a multiple of PBSLN. The default value is 0, but the recommended value is 8 (3x factor).</p> <table border="1" style="width: 100%; border-collapse: collapse;"> <thead> <tr> <th style="width: 20%;">VALUE</th> <th style="width: 80%;">MULTIPLIER</th> </tr> </thead> <tbody> <tr><td style="text-align: center;">0</td><td style="text-align: center;">1.00</td></tr> <tr><td style="text-align: center;">1</td><td style="text-align: center;">1.25</td></tr> <tr><td style="text-align: center;">2</td><td style="text-align: center;">1.50</td></tr> <tr><td style="text-align: center;">...</td><td style="text-align: center;">$factor = \frac{(AUTO_GTHR_IN_MULT + 4)}{4}$</td></tr> <tr><td style="text-align: center;">14</td><td style="text-align: center;">4.50</td></tr> <tr><td style="text-align: center;">15</td><td style="text-align: center;">4.75</td></tr> </tbody> </table>	VALUE	MULTIPLIER	0	1.00	1	1.25	2	1.50	...	$factor = \frac{(AUTO_GTHR_IN_MULT + 4)}{4}$	14	4.50	15	4.75
VALUE	MULTIPLIER															
0	1.00															
1	1.25															
2	1.50															
...	$factor = \frac{(AUTO_GTHR_IN_MULT + 4)}{4}$															
14	4.50															
15	4.75															

Calibration Configuration Register Three (CALIBCFG3 0xDB)

Figure 77:
Calibration Configuration Register Three

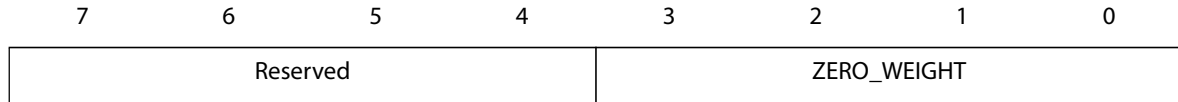

Field	Bits	Description			
ZERO_WEIGHT	3:0	<p>Zero Detection Weighting Filter. Sets the frequency of detection of zeroes necessary to raise the ZERO_DETECTED flag. ZERO_WEIGHT should only be used if DCAVG_AUTO_OFFSET_ADJUST and PROX_AUTO_OFFSET_ADJUST are NOT used, in other words, when offset adjustments are handled only by software. If the automatic on-chip adjustments are made, ZERO_WEIGHT has no purpose. ZERO_DETECTED is raised when an internal counter reaches a value of 15. During normal proximity/gesture operation, if any of the ADC values on the four channels is zero, the counter increments by ZERO_WEIGHT. Every time there are no zeroes, it decrements by 1. At each weight, there is an equilibrium frequency that will rarely raise the ZERO_DETECTED flag. For example, if ZERO_WEIGHT is set to 3, zero detection will be at equilibrium if there are 3 non-zero cycles for every 1 zero cycle, a 25% frequency of zeroes. Even at equilibrium, there is a chance that enough zeroes will occur in a short period of time to raise the ZERO_DETECTED flag. For each weighting, there is a never flag frequency below which it is exceedingly unlikely that the flag will be raised.</p>			
		VALUE	WEIGHT	EQUILIBRIUM FREQUENCY	NEVER FLAG FREQUENCY
		0	0	Never (Ignored)	Never (Ignored)
		1	1	50%	35%
		2	2	33%	16%
		3	3	25%	8%
		4	4	20%	4%
		5	5	17%	2%

Calibration Status Register (CALIBSTAT 0xDC)

Figure 78:
Calibration Status Register

7	6	5	4	3	2	1	0
Reserved				ZERO_ DETECTED	BASELINE_ ADJUSTED	OFFSET_ ADJUSTED	CALIB_ FINISHED

Field	Bits	Description
Reserved	7:4	Reserved.
ZERO_DETECTED	3	Zero Detected. Indicates that zeroes are being detected in proximity or gesture often enough to exceed the ZERO_WEIGHT conditions. Recalibration is recommended. Bit generates interrupt if CIEN is asserted. To prevent interrupt, set ZERO_WEIGHT to zero. Clear this bit by writing '1' to it.
BASELINE_ADJUSTED	2	Proximity/Gesture Baseline Adjusted. Indicates that the proximity baseline, PBSLN, has changed. This may occur in two ways: During DC averaging at calibration, if DCAVG_AUTO_BASELINE is asserted (independent of actual value). During regular proximity/gesture operation if DCAVG_AUTO_BASELINE is set and a new PBSLN_MEAS value is collected that is lower than previous PBSLN). Bit generates interrupt if CIEN is asserted. To prevent interrupt, set DCAVG_AUTO_BASELINE and PXDCAVG_AUTO_BASELINE to zero. Clear bit by writing '1' to it or by writing '1' to INTCLEAR_CINT.
OFFSET_ADJUSTED	1	Proximity/Gesture Offset Adjusted. Indicates that one or more proximity/gesture offset register values were automatically adjusted. Bit generates interrupt if CIEN is asserted. To prevent interrupt, set DCAVG_AUTO_OFFSET_ADJUST and PROX_AUTO_OFFSET_ADJUST to zero. Clear bit by writing '1' to it.
CALIB_FINISHED	0	Calibration Finished. Indicates that calibration is complete. Bit generates interrupt if CIEN is asserted. Clear bit by writing '1' to it.

Interrupt Enable Register (INTENAB 0xDD)

Figure 79:
Interrupt Enable Register

7	6	5	4	3	2	1	0
ASIEN	PGSIEN	PIEN	AIEN	IIEN	GIEN	CIEN	Reserved

Field	Bits	Description
ASIEN	7	ALS Saturation Interrupt Enable. When asserted permits ALS saturation interrupts to be generated. Bit is mirrored in the CFG1 register.
PGSIEN	6	Proximity Saturation Interrupt Enable. When asserted permits proximity saturation interrupts to be generated. Bit is mirrored in the CFG1 register.
PIEN	5	Proximity Interrupt Enable. When asserted permits proximity interrupts to be generated, subject to the proximity thresholds and persistence filter. Bit is mirrored in the ENABLE register.
AIEN	4	ALS Interrupt Enable. When asserted permits ALS interrupts to be generated, subject to the ALS thresholds and persistence filter. Bit is mirrored in the ENABLE register.
IIEN	3	IRBeam Interrupt Enable. When asserted permits IRBeam interrupts to be generated. Bit is mirrored in the ICONFIG register.
GIEN	2	Gesture Interrupt Enable. When asserted permits all gesture-related interrupts to occur. The first gesture interrupt is subject to GFIFOTHR. Bit is mirrored in the GST_CTRL register.
CIEN	1	Calibration Interrupt Enable. When asserted permits calibration interrupts to be generated.
Reserved	0	Reserved.

Interrupt Clear Register (INTCLEAR 0xDE)

Figure 80:
Interrupt Clear Register

7	6	5	4	3	2	1	0
INTCLEAR_ ASAT	INTCLEAR_ PGSAT	INTCLEAR_ PINT	INTCLEAR_ AINT	INTCLEAR_ IINT	INTCLEAR_ GINT	INTCLEAR_ CINT	Reserved

Field	Bits	Description
INTCLEAR_ASAT	7	Clear Interrupt: Analog Saturation. Clears the analog saturation interrupt.
INTCLEAR_PGSAT	6	Clear Interrupt: Proximity Saturation. Clears the proximity saturation interrupt.
INTCLEAR_PINT	5	Clear Interrupt: Proximity. Clears the proximity interrupt.
INTCLEAR_AINT	4	Clear Interrupt: ALS. Clears the ALS interrupt.
INTCLEAR_IINT	3	Clear Interrupt: IRBeam. Clears the IRBeam interrupt.
INTCLEAR_GINT	2	Clear Interrupt: Gesture. Must be used to clear the gesture interrupt after device exits GMODE and GVALID is asserted. If there is a gesture interrupt because the gesture FIFO level (GFIFO_LVL) is above the gesture FIFO threshold (GFIFOTHR), INTCLEAR_GINT will not clear the interrupt. To clear the gesture interrupt in this case, the data in the FIFO must be read.
INTCLEAR_CINT	1	Clear Interrupt: Calibration. Clears the calibration interrupt.
Reserved	0	Reserved.

Gesture FIFO Access Registers (0xF8 – 0xFF)

Gesture data is stored in a 256 byte FIFO buffer containing 32 eight byte datasets. Each dataset contains one sample each of North, South, West, & East gesture data. If the FIFO overflows (i.e. 33 datasets before host/system reads data from the FIFO buffer), an overflow flag will be set and new data will be lost.

Host/Systems acquire gesture data by reading addresses: 0xF8 – 0xFF, which directly correspond to North, South, West, and East data points. The register address pointer automatically wraps from 0xFF to 0xF8. Data can be read one byte at a time (eight consecutive I²C transactions) or in blocks (there is no block-read length limit). When reading single bytes, the internal FIFO read pointer and the Gesture FIFO Buffer Level, GFIFO_LVL, are updated each time register 0xFF is read. For block-reads, the internal FIFO read pointer and the Gesture FIFO Buffer Level, GFIFO_LVL update for each eight byte dataset. If the FIFO continues to be accessed after GFIFO_LVL = 0, the device will return 0 for all data.

Gesture interrupts and the gesture valid (GVALID) flag indicate when there is valid data in the FIFO buffer. When the Gesture FIFO Buffer Level exceeds the Gesture Entry Threshold (GFIFO_LVL > GTHR_IN), a gesture interrupt is generated, and the GVALID flag is raised. Reading any data will clear the gesture interrupt, but GVALID will remain raised. A second interrupt is generated when the gesture is complete (GTHR_OUT conditions are met). The GVALID flag will remain raised until all data has been read, clearing the FIFO buffer. Once the FIFO buffer is empty, GVALID will be cleared to indicate that the gesture is complete and all data is read. The amount of unread data is indicated by the GFIFO_LVL.

Figure 81:
Gesture FIFO Access Registers

Field	Register	Bits	Description
GFIFO_N	0xF8	7:0	Gesture North FIFO low byte
	0xF9	15:8	Gesture North FIFO high byte
GFIFO_S	0xFA	7:0	Gesture South FIFO low byte
	0xFB	15:8	Gesture South FIFO high byte
GFIFO_W	0xFC	7:0	Gesture West FIFO low byte
	0xFD	15:8	Gesture West FIFO high byte
GFIFO_E	0xFE	7:0	Gesture East FIFO low byte
	0xFF	15:8	Gesture East FIFO high byte

Application Information

The typical application hardware circuit of this device is shown below.

Figure 82:
TMG4903 Typical Application Circuit

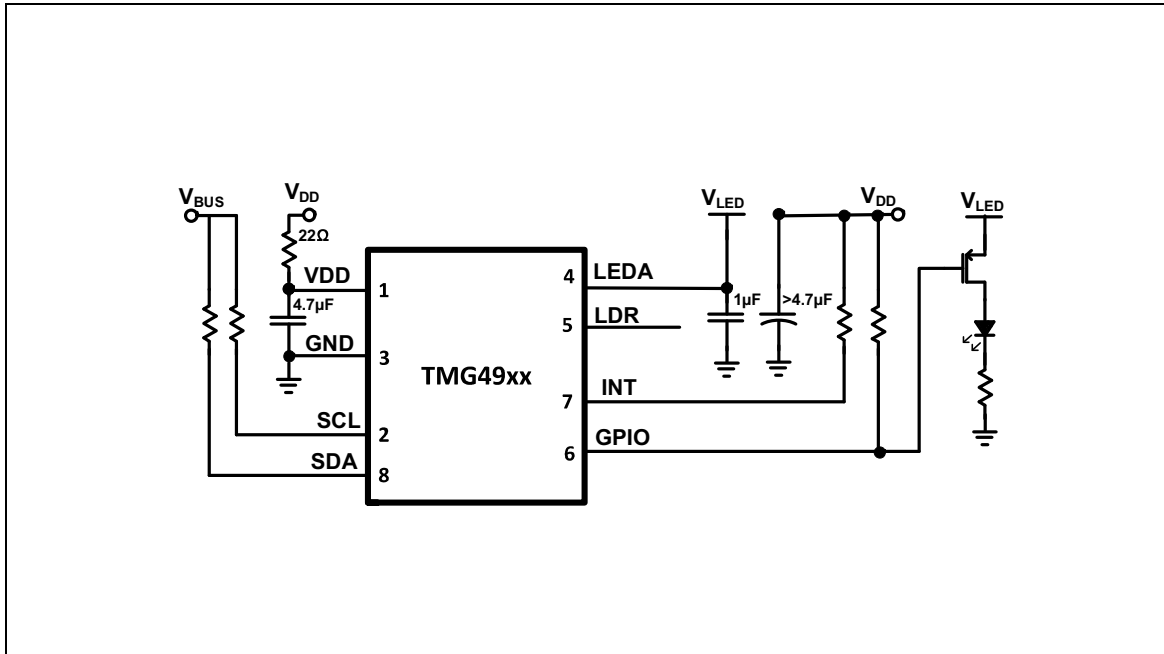
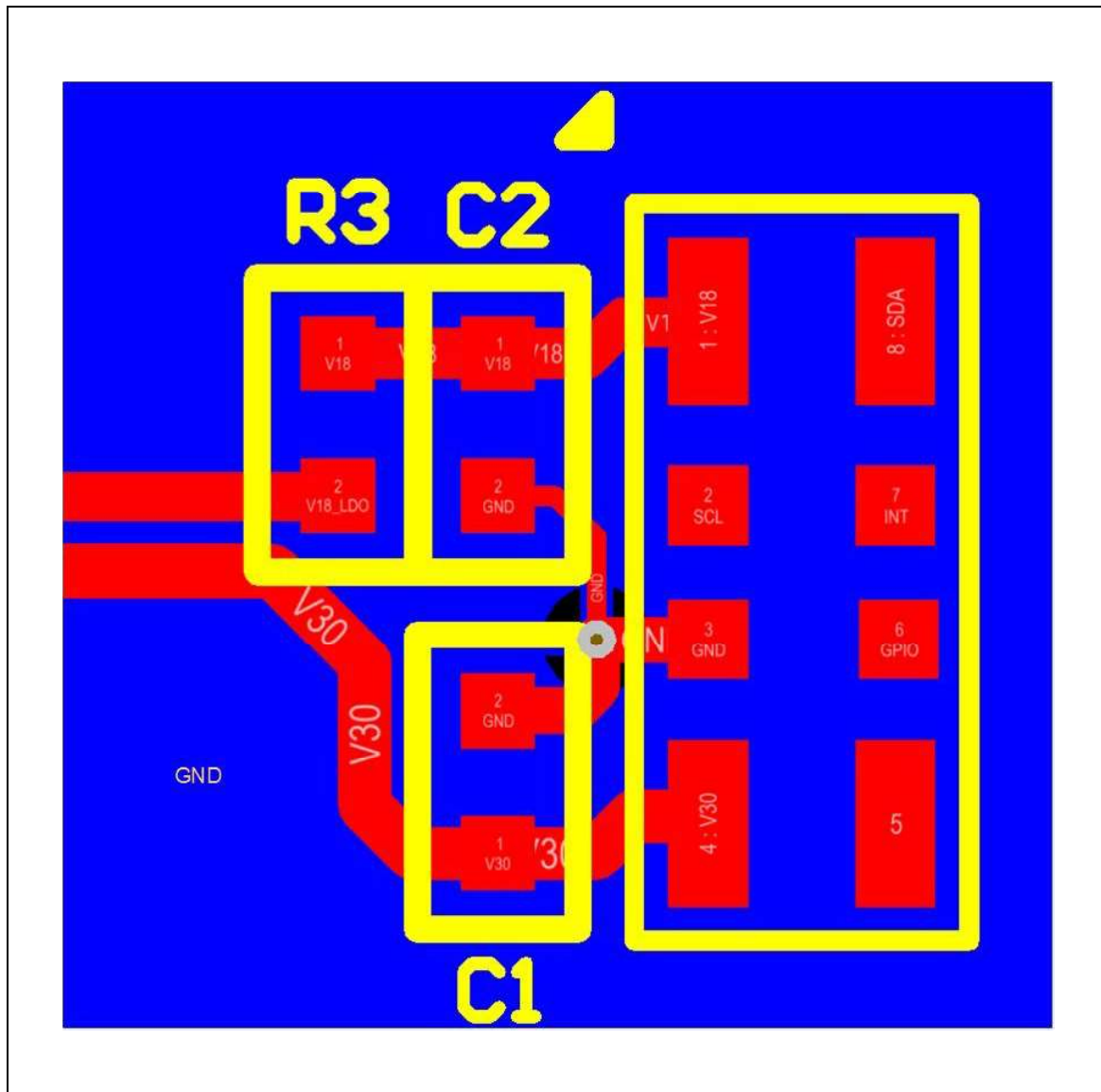

Figure 83:
TMG4903 Recommended Circuit Layout



Remote Control

General Description of RC Functionality

The TMG4903 is equipped with Remote Control functionality which is used to generate and transmit patterns over IR for electronic equipment (e.g. television, DVD, or audio receiver). Virtually all protocols can be accommodated by the specialized architecture of the Remote Control engine. The engine contains 256 bytes of pattern RAM and controls for carrier frequency, duty cycle and pattern repetition to easily create and broadcast a complete command waveform. The command waveform is output on a device pin allowing direct control of an external transistor and LED (pull-up resistor required). The integrated LED may also be used to output the IR waveform.

Detailed Descriptions of RC Functionality

Remote Control functionality uses a digital core that is independent of the analog sensor operation. The logic internal to the digital core is activated when IBEN=1. In this operational mode the LDR pin is exclusively acquired; during this time sensor functionality will not operate.

Most of the functional engines are controlled by dedicated registers; however, some devices use a "shared register" scheme. For example, this device uses address space: 0xA0 to 0xAF to also control mobeam operation. Because each functional block serves a different purpose and utilizes common on-chip resources, only one may be activated at a time.

Block Diagram of Remote Control Functionality

Figure 84:
Block Diagram of RC Functionality

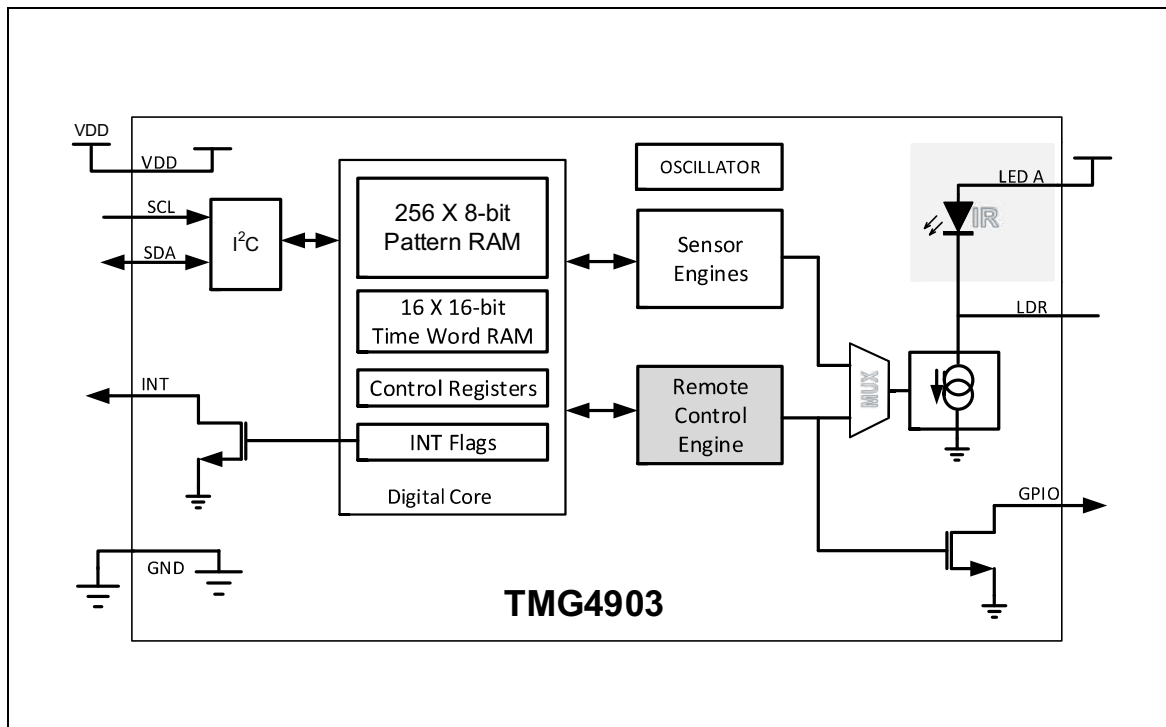

Block Diagram of RC Functionality: Resources associated with Remote Control.

There are many different remote control protocols currently in use; and to meet the multitude of requirements the remote control engine has been designed to be flexible. The remote control engine consists of four major components: Pattern RAM, Timeword RAM, control registers, and pattern output pin (or integrated LED).

Pattern RAM

The Pattern RAM is 256 bytes in length and is divided into two banks with 128 bytes each. Both banks must be used to enable all Pattern RAM. To access the Pattern RAM, write 0 or 1 to RAM_BANK (0x8D<0>). Functionally, the RAM is split into the MSB and LSB nibbles; each of which are used to index the Timeword RAM table. The MSB is used for “pulses”, and the LSB is used for “gaps”.

Figure 85:
Terminology of Pattern RAM

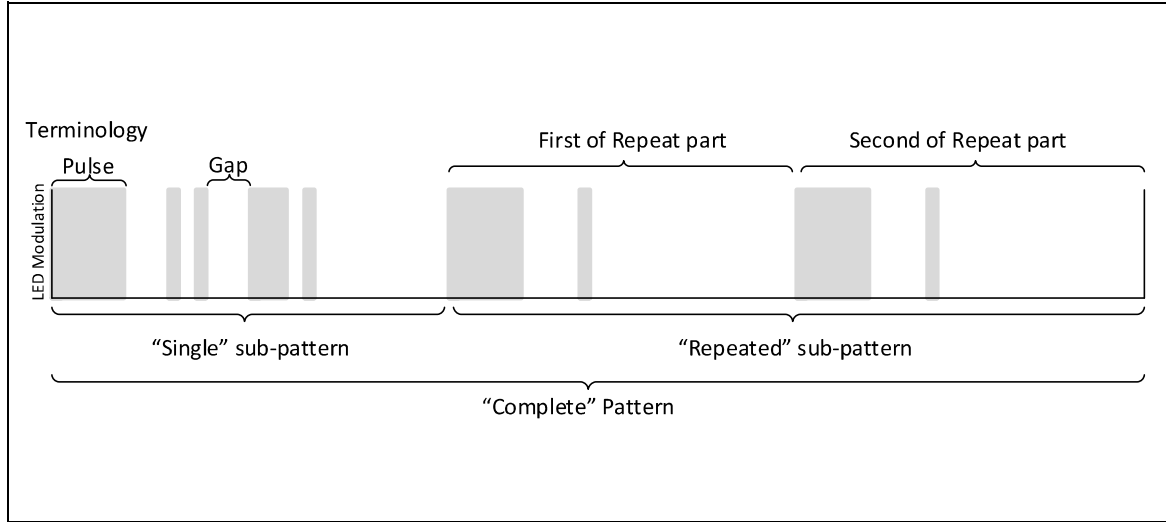

Terminology of Pattern RAM: Pulses/Gaps, and Single/Repeated/Complete Patterns are shown.

The pulse-gap pair defines when the LED is modulating or deactivated, respectively. The control logic processes the RAM locations sequentially until special operator values are encountered.

Figure 86:
Pattern RAM Table

Pattern RAM	
Address (Bank 0)	Data (Pulse-Gap)
0	0x0 to 0xFF
1	0x0 to 0xFF
2	0x0 to 0xFF
3	0x0 to 0xFF
~	~
255	0x0 to 0xFF

Pattern RAM: Volatile memory used for storing pattern data.

Note(s):

1. T_DATA = 0xFE is a special instruction. The following value in RAM becomes the start address of any repeated sub-pattern.
2. T_DATA = 0xFF is a special instruction. It identifies the end of the pattern.

There are two special values that control the flow of the pattern: Stop and Repeat-destination. A Stop is signified by the value of 0xFF loaded into a pattern ram location. The value is analogous to a *null* character at the end of a text file. Any remaining RAM after the 0xFF operator is encountered is not executed and the pattern is finished. The Repeat-destination operator is signified by a value of 0xFE followed by the start address of any repeated sub-pattern. This value is analogous to a “goto” statement. Once this value is encountered instruction pointer to the pattern RAM is changed to the address stored in the *next* pattern RAM location. These data values will not be decoded by the logic as a reference/pointer to the timeword table, that is, 0xFF will not index timeword location 15 for pulse and gap.

Timeword RAM

The Timeword RAM is a dedicated table that contains sixteen, 16-bit words which are used to set pulse and gap widths. The pulse and gap widths are described as a multiple of carrier periods, T_{CAR} . For example, if the LED must modulate for 8 carrier periods, then be off for 15 carrier periods, index 0 could be loaded with 0x0008 and index 1 could be loaded with 0x000F. A pattern RAM value of 0x01 would result in LED activation for 8 T_{CAR} s, as stored in index 0, and a LED deactivation for 15 T_{CAR} s.

Similarly to pattern RAM, the Timeword table also has a special operator. If the timeword value is zero, then whatever state the LED was in last (i.e. modulating or deactivated) will be continued into the next pulse or gap defined in pattern RAM. For example, if the RAM Pulse nibble (MSB) indexes a timeword set to 5, and the gap (LSB) nibble indexes a timeword set to 0, the LED will modulate for 5 T_{CAR} s then instead of deactivating, the modulation is continued into the next pulse in pattern RAM. In this way pulses or gaps longer than 65535 T_{CAR} s can be generated.

Figure 87:
Timeword RAM Table

Timeword RAM			
T_INDEX	T_DATA	I ² C Address (Bank 1)	
0	0 to 65535	0x01 8-bit MSB	0x00 8-bit LSB
1	0 to 65535	0x03 8-bit MSB	0x02 8-bit LSB
2	0 to 65535	0x05 8-bit MSB	0x04 8-bit LSB
3	0 to 65535	0x07 8-bit MSB	0x06 8-bit LSB
~	~	~	~
15	0 to 65535	0x0F 8-bit MSB	0x1E 8-bit LSB

Timeword RAM: Volatile memory used for storing 16-bit timing data.

The Timeword table is located in RAM bank two. Each 16-bit word is accessible using two byte locations: MSB bytes are stored in even addresses and LSBs are stored in odd addresses. For example, if 0x2953 is to be stored at index 0, then 0x29 is written to: bank 2, I²C address of 0x00, and 0x53 is written to bank 2, I²C address of 0x01.

Control Registers

The remote control engine has 19 fields that govern pattern timing and flow, output selection, and report status. All pertinent fields are listed in the figure below.

Figure 88:
Remote Control Registers and Fields

Register / Bit	Address	Description
ENABLE<PON>	0x80<0>	Power On
ENABLE<IBEN>	0x80<7>	IRBeam Enable
CFG0 <RAM_BANK>	0x8D<0>	RAM Bank Select
PGCFG1 <PGLDRIVE>	0x8F<4:0>	LED Drive Strength
STATUS <IINT>	0x93<3>	IRBeam Interrupt (mirrors ISTATUS<IINT>)
ICONFIG <IEN>	0xA0<5>	IRBeam Interrupt Enable
ICONFIG2 <IINVERT>	0xA1<5>	IRBeam Polarity Inversion
ICONFIG2 <IOUTPUT>	0xA1<4:3>	Output Select
ICONFIG2 <IRCDCMODE>	0xA1<2>	DC Carrier Select
ICONFIG2 <IDUTY>	0xA1<1:0>	Duty Cycle Select
ISNL <ISNL>	0xA2<7:0>	Number of Repeated Sub-pattern Loops
ISOFF <ISOFF>	0xA3<7:0>	Pause between Sub-pattern Bursts
IPNL <IPNL>	0xA4<7:0>	Number of Complete Pattern Loops
IPOFF <IPOFF>	0xA5<7:0>	Pause between Pattern Bursts
IBT <IBT>	0xA6<5:0>	Carrier Selection Time
ISTATUS <IINT>	0xA8<1>	IRBeam Interrupt
ISTATUS <IBUSY>	0xA8<0>	IRBeam Busy
ISTART <ISTARTREMCON>	0xA9<1>	Remote Control Start Pattern Burst
INTCLEAR <INTCLEAR_IINT>	0xDE<3>	IRBeam Interrupt Clear

Pertinent Control Registers: Resources associated with Remote Control.

Carrier frequency, Duty cycle, and Pause (the delay between complete patterns) comprise the registers associated with timing. Carrier periods are selectable in 250ns increments in with register settings in the range of 8 to 255. Carrier frequencies are in the range of 16 kHz to 460 kHz. Typical carrier frequencies are listed in the table below. Protocols that do not use carriers can also be accommodated by enabling the DC Carrier Selection bit. The duty cycle of the carrier is selectable as: 50%, 37%, 25%, and 12%. Note that these duty cycles do not translate exactly to the actual LED duty cycle, depending on the external circuit. Finally, if desired, complete pattern rebursts are separated by a selectable delay of 0µs to 2.55s, in 10µs increments.

Figure 89:
Carrier Frequencies

Desired Frequency (kHz)	Generated Frequency (kHz)	IBT
36	36.04	111
38	38.10	105
40	40.00	100
56	56.34	71
450	444.44	9

Carrier Frequencies: Typical carrier frequencies can be reproduced to closely match the desired value.

Controls associated with the output are:
Output select, Output Polarity Inversion, and LED Drive Strength. Output Select is used to choose output on the integrated LED or the GPIO pin. The polarity inversion control inverts the waveform on both the LED and the GPIO pin if enabled. The LED Drive Strength controls the current through the integrated LED which effectively sets its intensity.

Controls associated with interrupts are:
Pattern Burst Interrupt Enable, Pattern Burst Interrupt flag, Pattern Burst Interrupt Clear, Pattern Burst Interrupt Force, and Pattern Burst Busy. Following an entire pattern burst, including all repeats, loops, and delays, a pattern burst interrupt bit is set. This bit is readable from two locations: STATUS register and ISTATUS register. If the interrupt enable bit is set, then the INT pin will also activate when the burst is finished. To clear the interrupt, the host must write a zero to IRBeam Interrupt Clear (0xDE<3>). For debugging purposes the interrupt bits and pin can be forced to activate by setting the Pattern Burst Interrupt Force bit. The Pattern Burst Busy bit is automatically set whenever a pattern is actively being transmitted; it is reset once the remote control engine returns to the IDLE state.

Controls associated to define the number of complete pattern loops and sub-pattern repeats are: Number of Repeated Sub-pattern Loops and Number of Complete Pattern Loops.

As depicted below, the number of “run-once” pattern loops sets the amount of *additional* iterations, up to 254. If the register is set to 0xFF then the sub-pattern is continuously repeated until the value is changed or IBEN bit is reset.

Figure 90:
Complete Pattern Loops

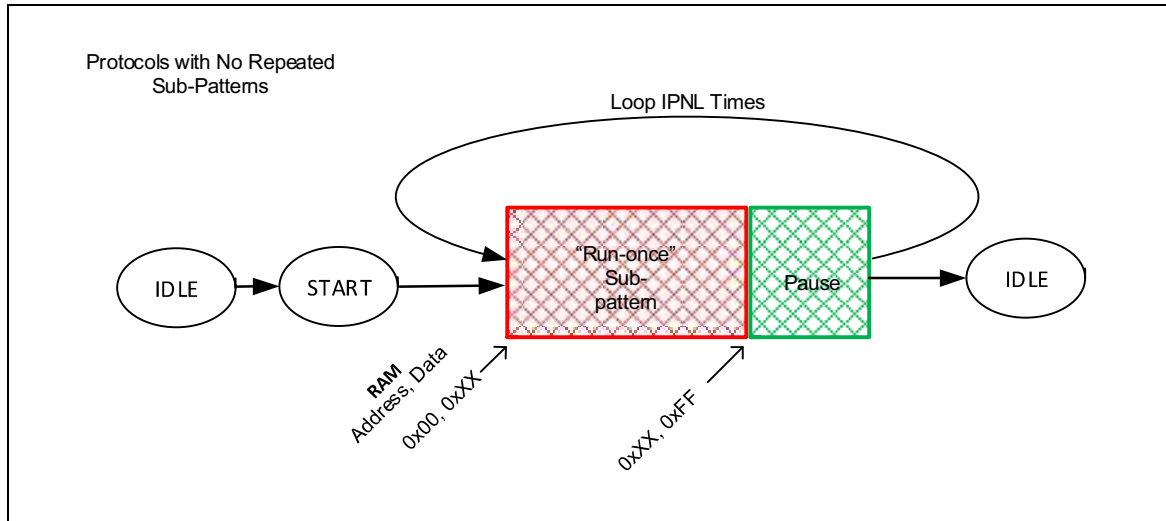

Complete Pattern Loops: The red box represents a “run-once” pattern. The pattern begins at pattern ram address 0x00 and bursts until the end of the pattern is encountered. The complete pattern can be reiterated 1 to 254 times, or continuously.

As depicted below, the number of repeated sub-pattern loops sets the amount of additional “repeated part” burst iterations, up to 254. If the register is set to 0xFF then the sub-pattern is continuously repeated until the value is changed or IBEN bit is reset.

Figure 91:
Number of Repeated Sub-Pattern Loops

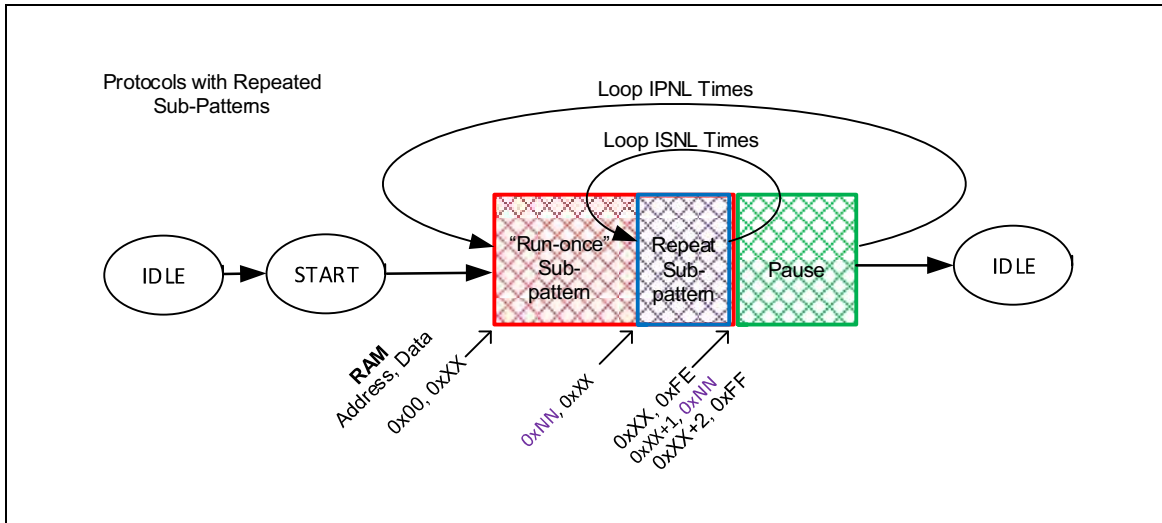

Protocols with “Repeated” Sub-Patterns: The blue box represents a repeated part of a pattern. These sub-patterns begin at an address within the red box and burst until the end of the pattern is encountered. The repeated sub-pattern can be reiterated 1 to 254 times, or continuously.

Digital Logic

The Simplified Flow Diagram depicts the basic premise of how an entire waveform is generated. Protocols of the form described in Figure 90 and Figure 91 can be generated using the mechanism depicted below. Any functionality shown in the red, blue, or green boxes can be activated or omitted via control register settings or special operators in pattern RAM to produce virtually any waveform.

Typically, patterns are built by assembling pulses and gaps in a particular order. To this end the length of time for each pulse and gap, measured in multiples of carrier periods, as well as the order of each pulse/gap pair are specified in the equipment/button data. The remote control engine can directly accept the data in this format. Pulse/Gap order is stored in pattern RAM and pulse/gap time durations are stored in the Timewords table.

Figure 92:
Simplified Flow Diagram

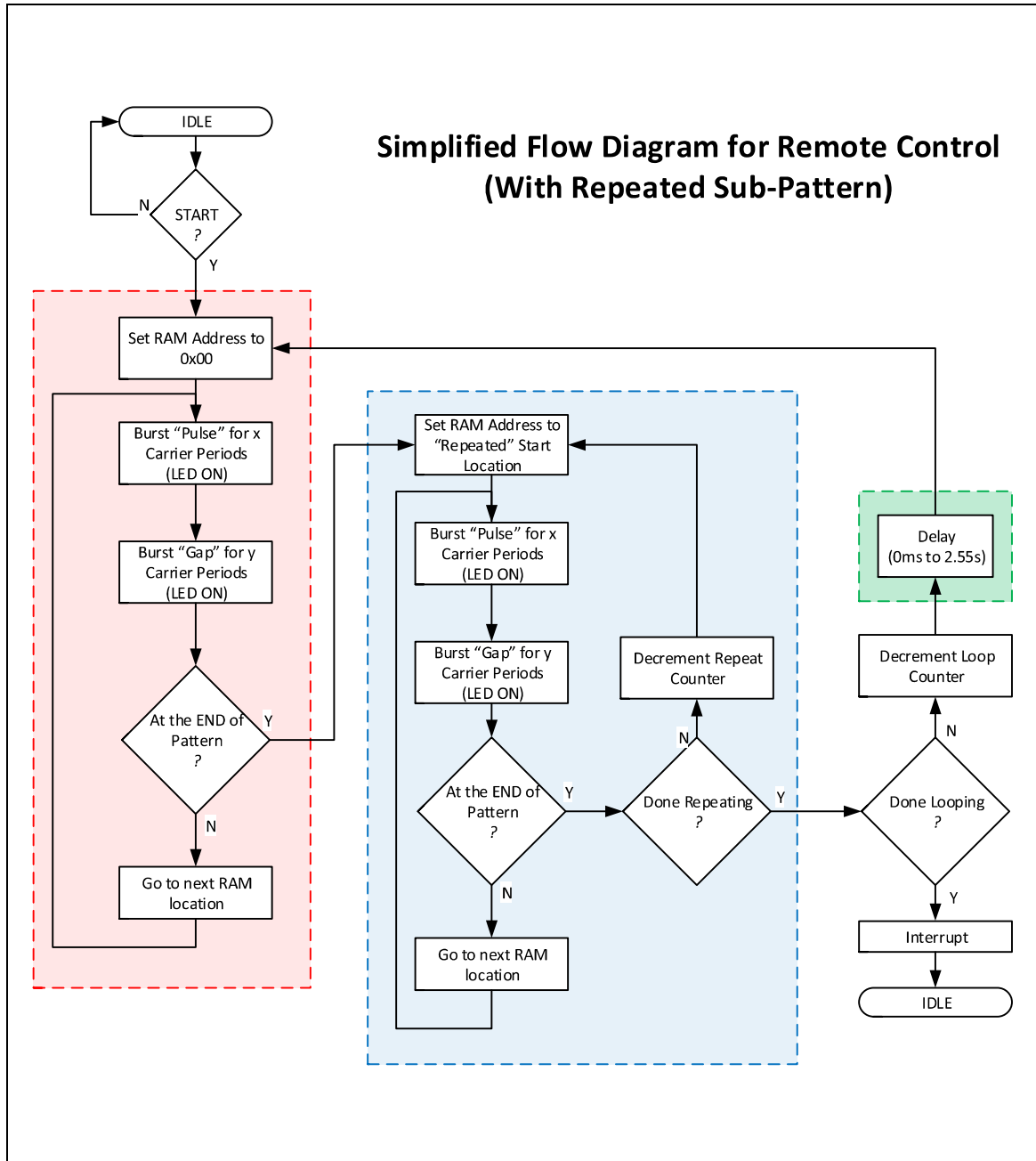

Simplified Flow Diagram: The digital logic in the remote control engine has been tailored to fit the data format and protocol specifications for IR remote control. “Press and Release” type buttons (e.g. Power) are generated using the logic in the red box (logic in the blue box is not needed). “Press and Hold” type buttons (e.g. Volume+) are generated using logic in both the red and blue boxes.

The digital logic in the remote control engine has been tailored to fit the data format and protocol specifications for IR remote control. “Press and Release” type buttons (e.g. Power) are generated using the logic in the red box. “Press and Hold” type buttons (e.g. Volume+) are generated using logic in both the red and blue boxes. Figure 93 depicts how a command pattern with a repeated sub-pattern is created using the logic shown in the Simplified Flow Diagram. All of the “run-once” sub-pattern and the “first” instance of the “repeated” sub-pattern is actually run by the logic in the red box. The second instance of the “repeated” sub-pattern is run by the logic in the blue box.

Figure 93:
Pattern Generation by Logical Block

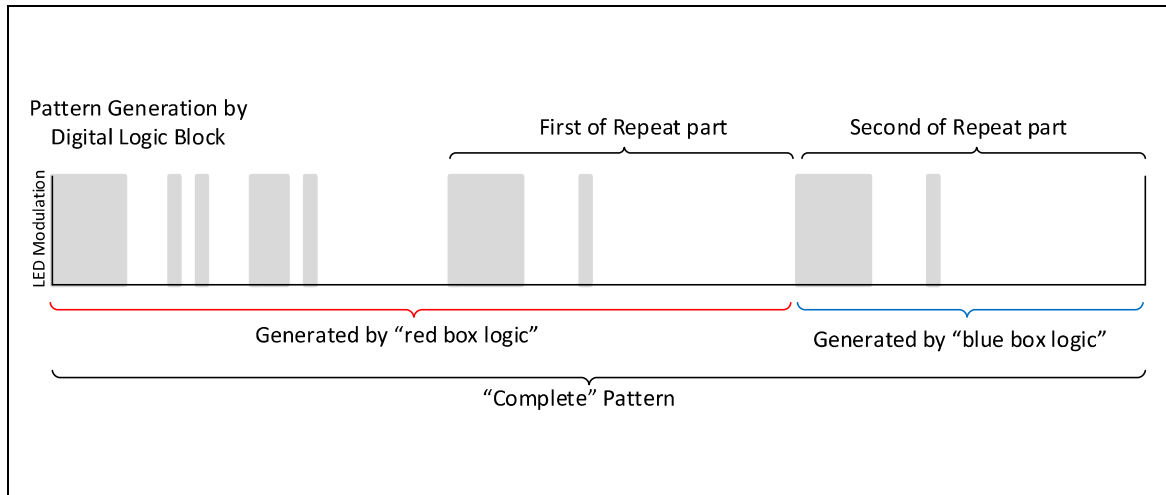

Pattern Generation: All of the “one-time” sub-pattern and the “first” instance of the “repeated” sub-pattern is actually run by the logic in the red box. The second instance of the “repeated” sub-pattern is run by the logic in the blue box.

Complete patterns can also be automatically reburst from 1 to 254 times or continuously. Complete patterns can also be separated by a pause, or time delay, as generated by the logic in the green block. The entire pattern consists of a multiple of complete patterns and pause delays. During this length of time the entire pattern is bursting the IBUSY bit is set. Upon completion the IBUSY bit is cleared and the interrupts are set.

Figure 94:
Entire Pattern Waveform

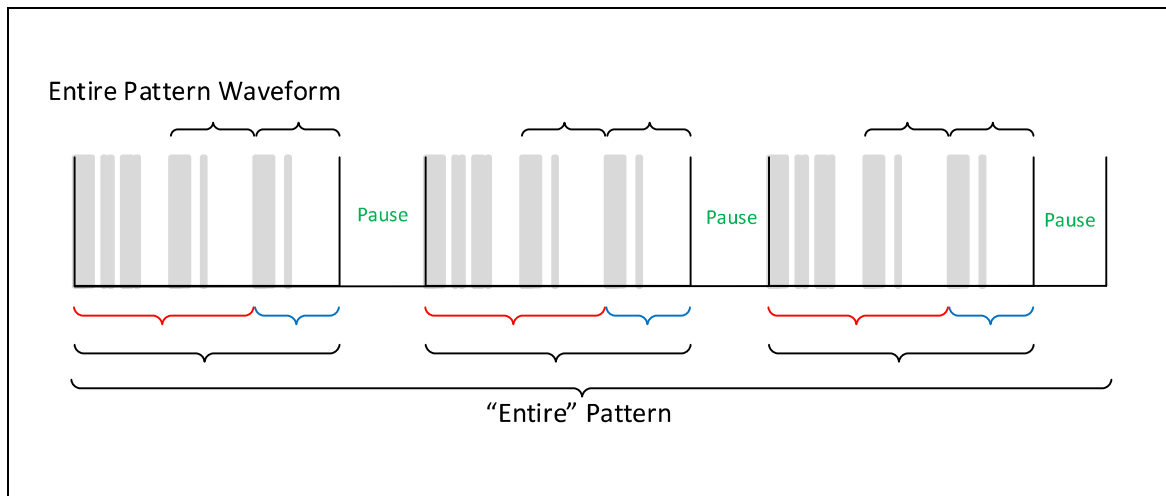

Entire Pattern: Complete patterns can also be separated by a pause, or time delay, as generated by the logic in the green block. The entire pattern consists of a multiple of complete patterns and pause delays. During the length of time the entire pattern is bursting, the PBUSY bit is set.

Refer to the Remote Control Engine diagram which depicts the how the engine functions in great detail.

Figure 95:
Detailed Flow Diagram of the Remote Control Engine

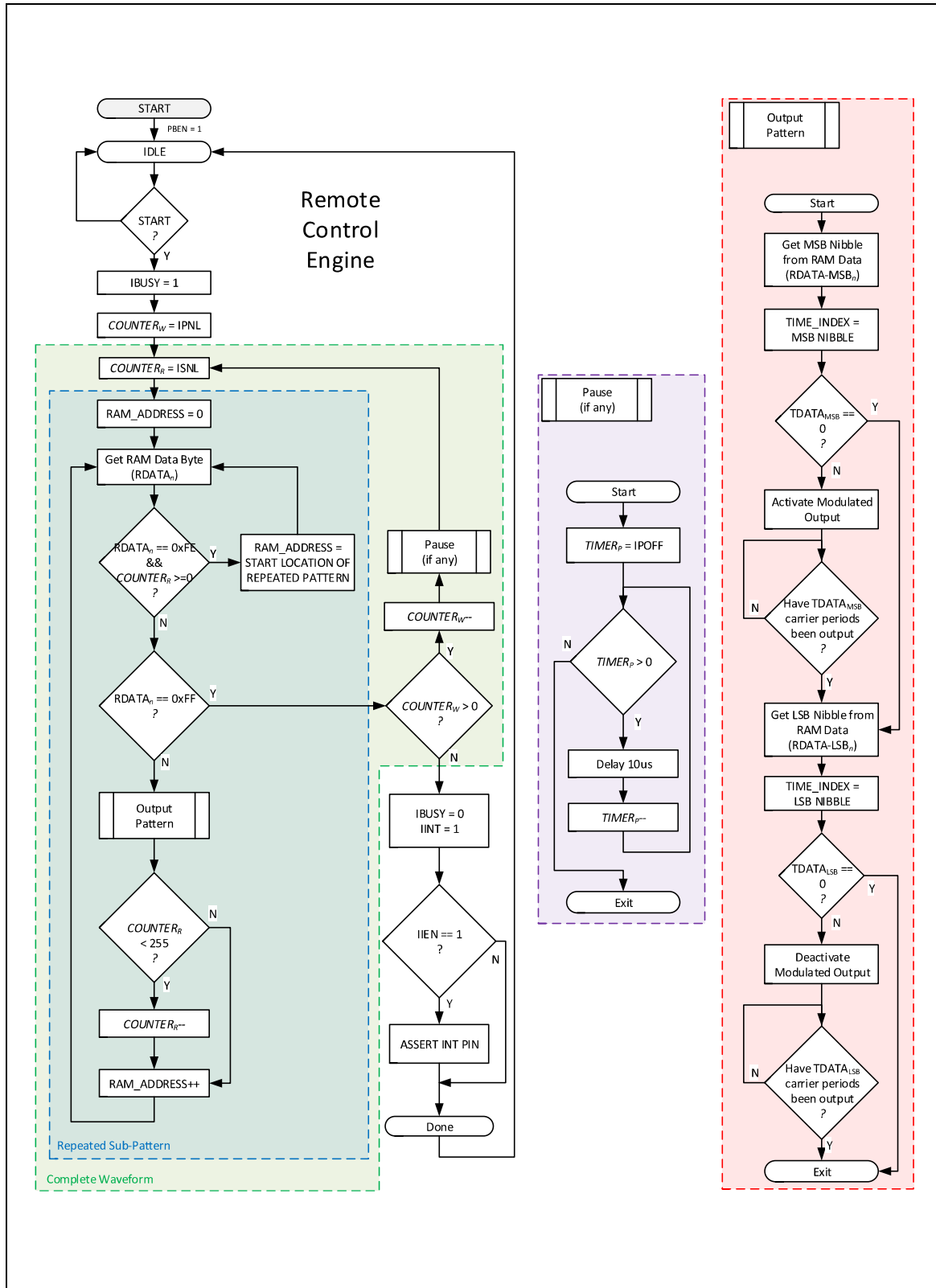

Remote Control Engine: Complete guide to the inner workings and use of the remote control functionality.

Electrical and Optical Output

The electrical or optical output of the remote control engine can be realized in three ways: use of the integrated top-facing LED, use of the LDR pin to directly drive an external LED, or use of the GPIO pin to drive an external FET and IR LED.

The LDR pin has a regulated current sink with selectable drive value. This is an attractive way to use an external LED without having an additional LED drive FET. If this method is to be used, then LEDA must be disconnected from the circuit. Since the cathode of the integrated LED is connected to the LDR pin internal to the module any current that is sourced through LEDA will reduce the current available on the external remote control LED. When the remote control functionality is not used the external LED must be electrically disconnected from the LDR pin to prevent it from illuminating.

Figure 96:
External IR LED Using the LDR Pin

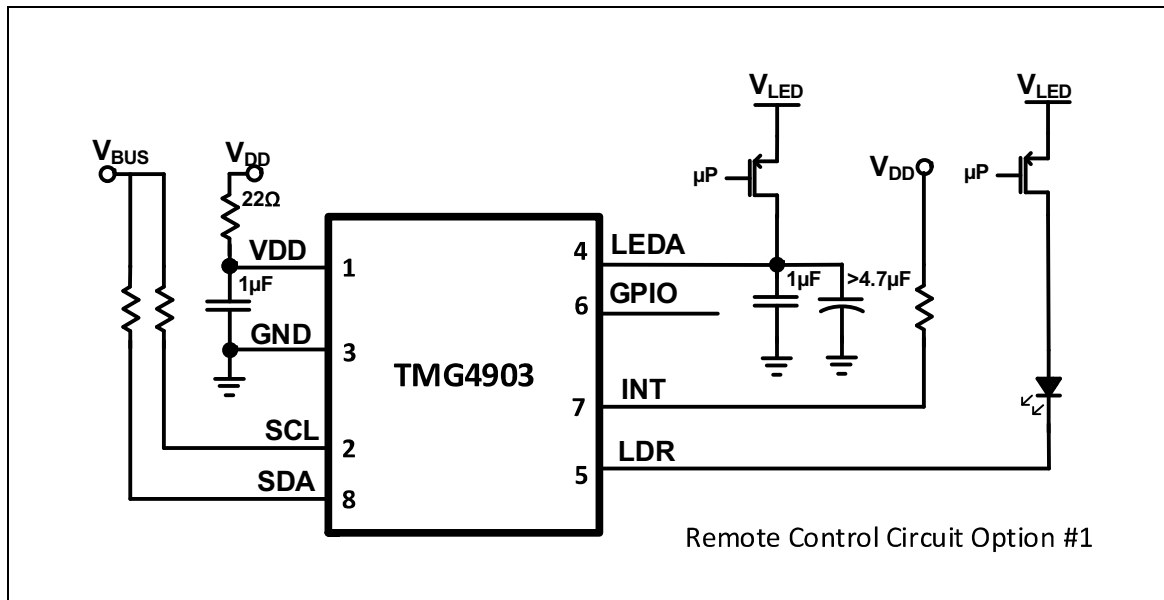

Recommended Connection: Option number one.

If the LDR pin is not used as the pattern output, the GPIO pin can be used. With this method both the LEDA and external remote control IR LED may remain connected to the LED power supply, but an additional FET is needed to drive the remote control LED.

Figure 97:
External IR LED Using the GPIO Pin

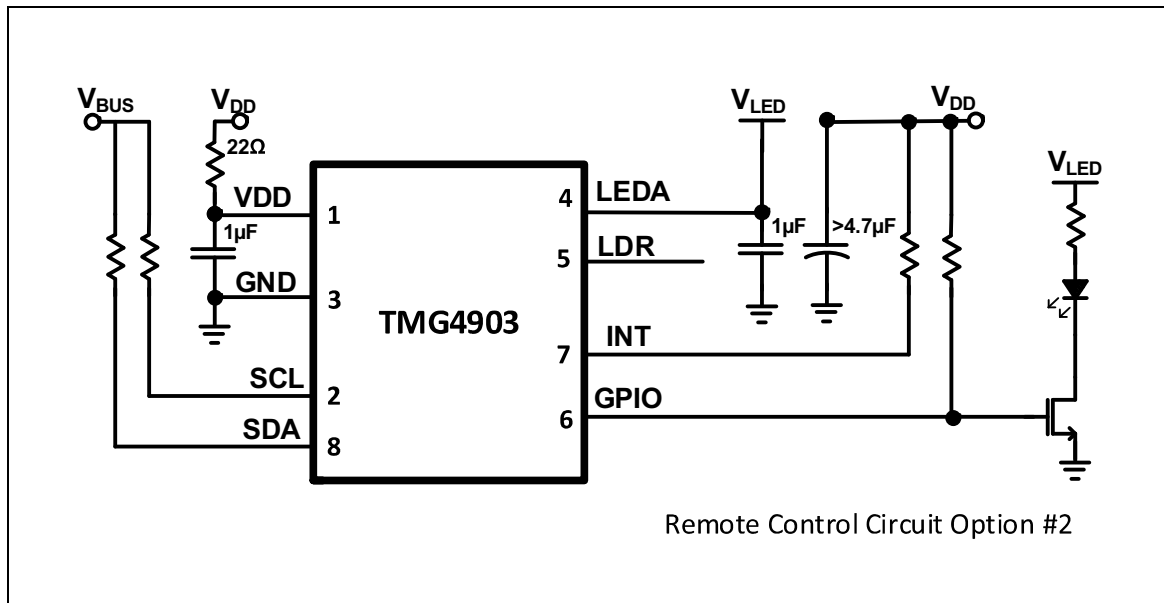

Recommended Connection: Option number two.

Example Waveform and Device Setup

A practical example is included to describe how each register is used and how to setup the device to burst a real waveform. The physical waveform, as seen on an oscilloscope, is described by the depiction in Figure 95. The Figure 98 depicts the mechanics to precondition the remote control engine for proper operation.

Figure 98:
Practical Example

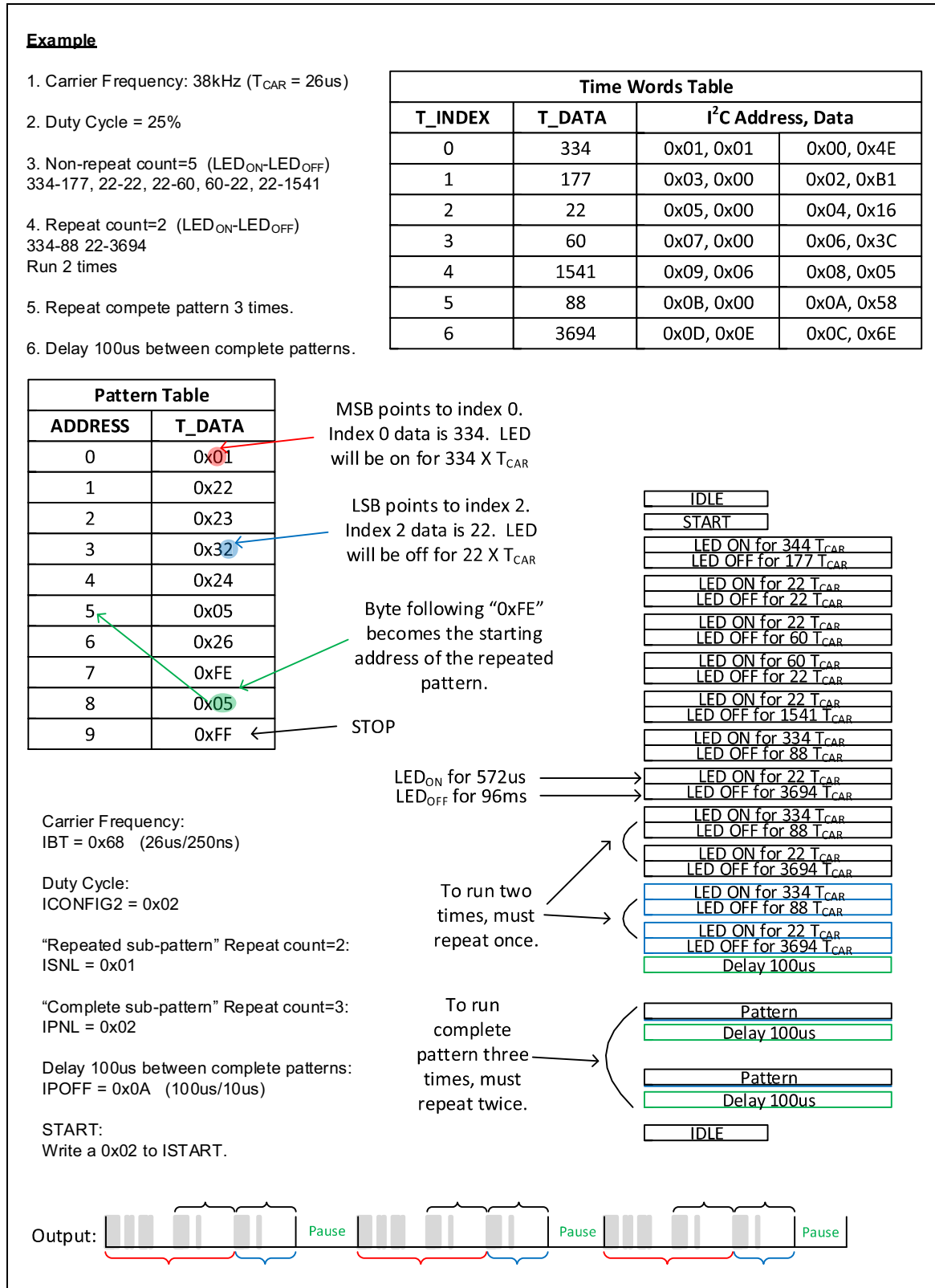

Practical Example: Device registers and RAM are loaded with values to generate a real remote control waveform.

Protocol Accommodation Checklist

The Remote Control pattern generation/transmission feature can be configured to broadcast virtually all IR communication protocols used for commanding consumer electronic devices. There are many different remote control protocols currently in use; and to meet the multitude of requirements the remote control engine has been designed to be flexible. In general, a protocol functions within the following transmission specifications can be accommodated:

- Carrier periods are selectable in 250ns increments. Carrier frequencies are in the range of 15.625 kHz to 460 kHz. Protocols that do not use carriers can also be accommodated.
- Duty cycle of the carrier is selectable: 50%, 37%, 25%, and 12%. Exact LED duty cycle depends on the external circuit.
- Pulse (LED on) and Gap (LED off) widths are a multiple of carrier periods (T_{CAR}). Pulse and Gap length is selectable from 0 to 65535 carrier periods. Patterns with exceptionally long pulses or gaps (i.e. longer than 65535 carrier periods) may be accommodated. This requires setting contiguous pattern ram locations, but results in a glitch-free long pulse/gap.
- A dedicated “time word” RAM table contains sixteen, 16-bit words which are used to set pulse and gap widths. Simply stated, a pattern must contain sixteen or fewer unique pulse/gap widths. Note: patterns containing more than 16 unique pulse/gap widths may be accommodated by using the 16-bit timewords as “building blocks” to form longer pulse/gaps. For example, if a pattern has a pulse/gap of both $3T_{CAR}$ and $6T_{CAR}$, then only the $3T_{CAR}$ need be represented in the Time Word table; then the $6T_{CAR}$ can be generated by indexing into the $3T_{CAR}$ twice (This requires the use of additional pattern RAM).
- A dedicated “pattern” RAM contains 256 bytes of data. Each byte indexes into the Timeword table to form a complete pulse and gap pair. A pattern that does not contain a “repeated” sub-pattern must have 255 or fewer pulse/gap pairs. A pattern that contains a “repeated” sub-pattern must have 254 or fewer pulse/gap pairs, not including the *additional* repetitions of the “repeated” sub-pattern.
- Entire patterns can be reburst up to an additional 255 times and are separated by a selectable delay of 0 μ s to 2.55s, in 10 μ s increments.

Package Drawings & Markings

Figure 99:
TMG4903 Module Dimensions

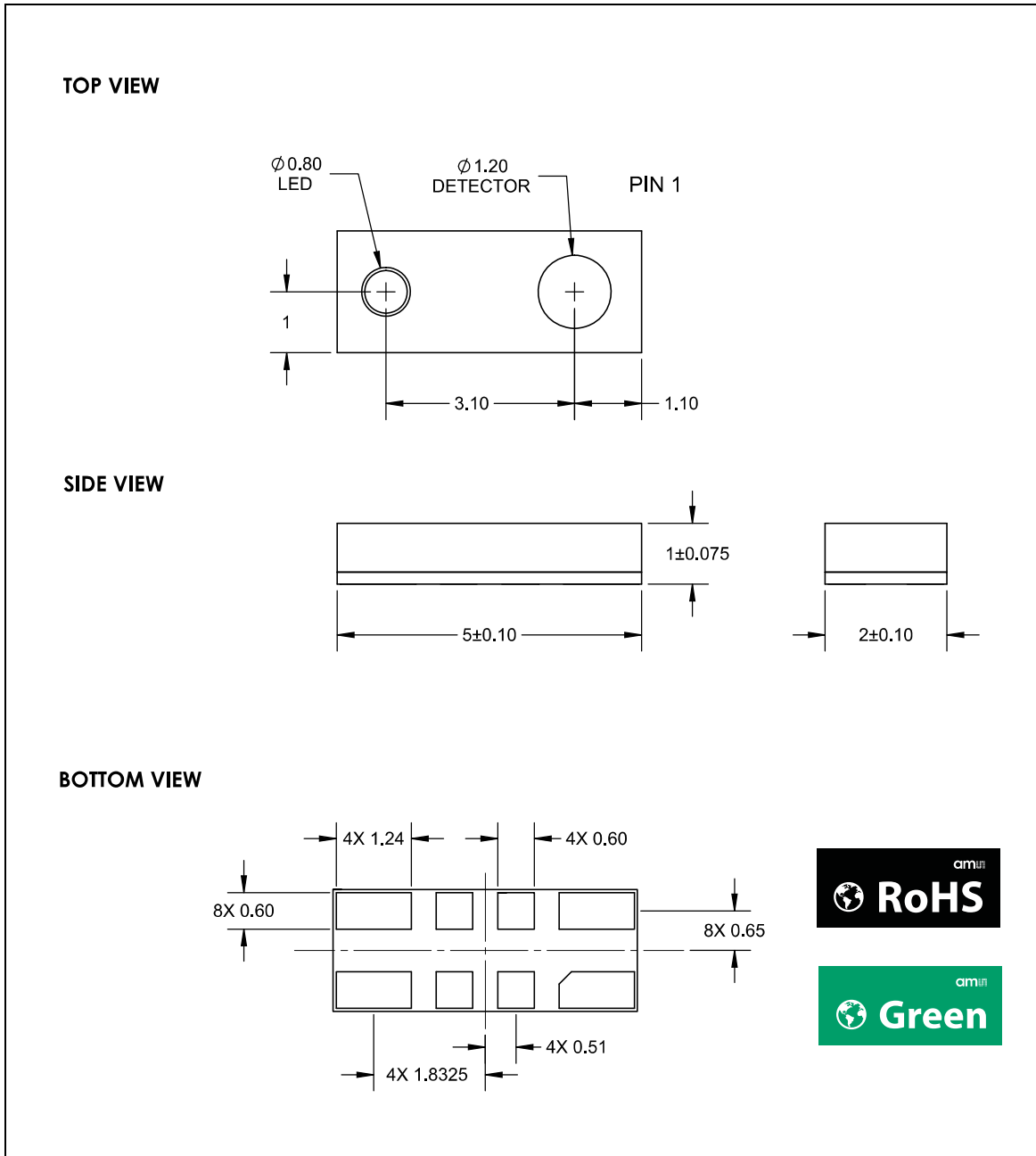

Note(s):

1. Package type: oLGA8
2. All linear dimensions are in millimeters.
3. Dimension tolerances are $\pm 0.05\text{mm}$ unless otherwise noted.
4. Contacts are copper with NiPdAu plating.
5. This package contains no lead (Pb).
6. This drawing is subject to change without notice.
7. Measurement guarantee by lot acceptance testing using 20 units.

PCB Pad Layout

Suggested PCB pad layout guidelines for the surface mount module are shown. Flash Gold is recommended as a surface finish for the landing pads.

Figure 100:
Recommended PCB Pad Layout

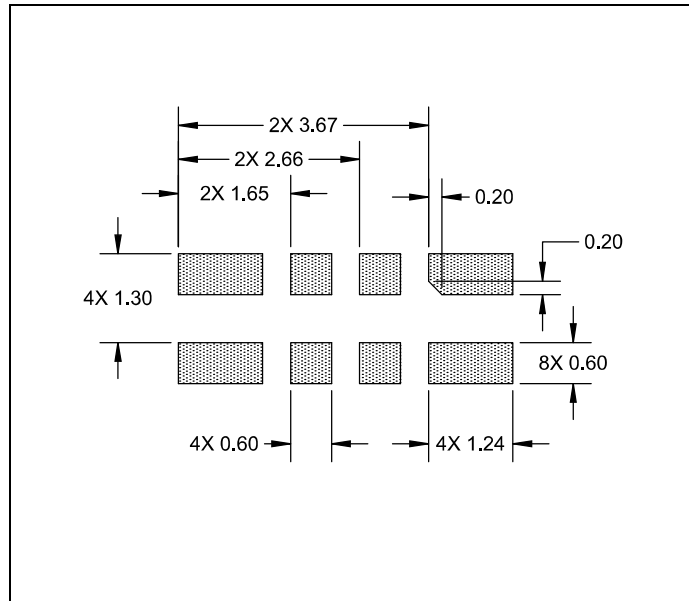

Note(s):

1. All linear dimensions are in millimeters.
2. Dimension tolerances are $\pm 0.05\text{mm}$ unless otherwise noted.
3. This drawing is subject to change without notice.

Soldering and Storage Information

Soldering Information

The module has been tested and has demonstrated an ability to be reflow soldered to a PCB substrate.

The solder reflow profile describes the expected maximum heat exposure of components during the solder reflow process of product on a PCB. Temperature is measured on top of component. The components should be limited to a maximum of three passes through this solder reflow profile.

Figure 102:
Solder Reflow Profile

Parameter	Reference	Device
Average temperature gradient in preheating		2.5 °C/s
Soak time	t_{soak}	2 to 3 minutes
Time above 217 °C (T1)	t_1	Max 60s
Time above 230 °C (T2)	t_2	Max 50s
Time above $T_{\text{peak}} - 10\text{ °C}$ (T3)	t_3	Max 10s
Peak temperature in reflow	T_{peak}	260 °C
Temperature gradient in cooling		Max -5 °C/s

Figure 103:
Solder Reflow Profile Graph

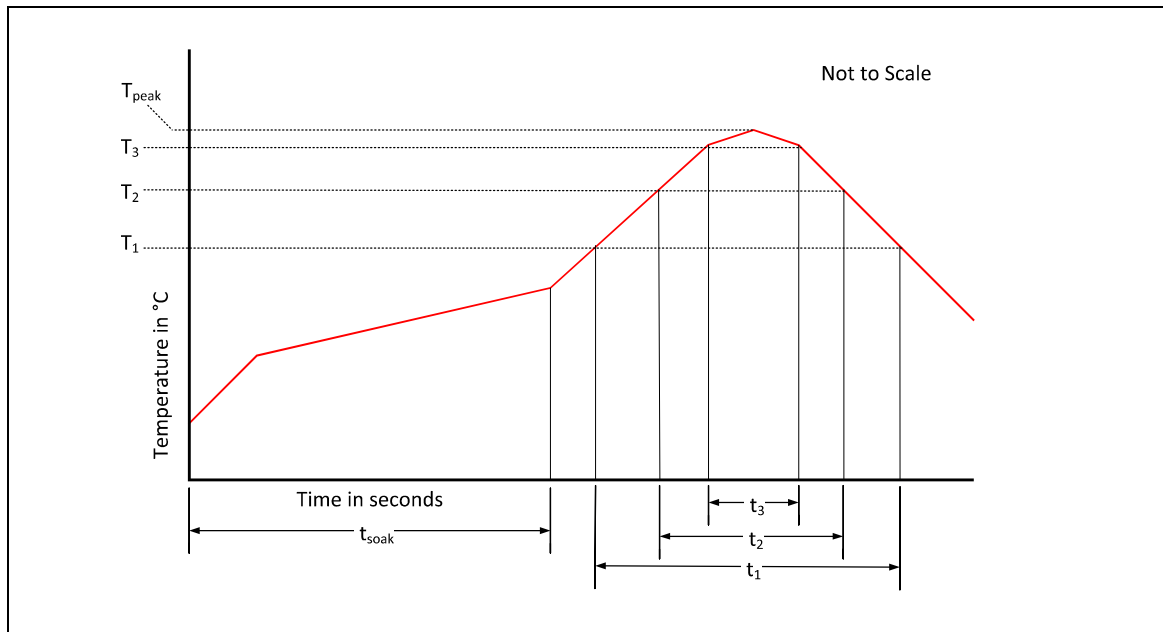

Storage Information

Moisture Sensitivity

Optical characteristics of the device can be adversely affected during the soldering process by the release and vaporization of moisture that has been previously absorbed into the package. To ensure the package contains the smallest amount of absorbed moisture possible, each device is baked prior to being dry packed for shipping.

Devices are dry packed in a sealed aluminized envelope called a moisture-barrier bag with silica gel to protect them from ambient moisture during shipping, handling, and storage before use.

Shelf Life

The calculated shelf life of the device in an unopened moisture barrier bag is 12 months from the date code on the bag when stored under the following conditions:

- Shelf Life: 12 months
- Ambient Temperature: <40°C
- Relative Humidity: <90%

Rebaking of the devices will be required if the devices exceed the 12 month shelf life or the Humidity Indicator Card shows that the devices were exposed to conditions beyond the allowable moisture region.

Floor Life

The module has been assigned a moisture sensitivity level of MSL 3. As a result, the floor life of devices removed from the moisture barrier bag is 168 hours from the time the bag was opened, provided that the devices are stored under the following conditions:

- Floor Life: 168 hours
- Ambient Temperature: <30°C
- Relative Humidity: <60%

If the floor life or the temperature/humidity conditions have been exceeded, the devices must be rebaked prior to solder reflow or dry packing.

Rebaking Instructions

When the shelf life or floor life limits have been exceeded, rebake at 50°C for 12 hours.

Ordering & Contact Information

Figure 104:
Ordering Information

Ordering Code	Address	Interface	Delivery Form
TMG49033	0x39	I ² C bus = 1.8V Interface	Tape & Reel
TMG49037	0x29	I ² C bus = 1.8V Interface	Tape & Reel

Buy our products or get free samples online at:

www.ams.com/ICdirect

Technical Support is available at:

www.ams.com/Technical-Support

Provide feedback about this document at:

www.ams.com/Document-Feedback

For further information and requests, e-mail us at:

ams_sales@ams.com

For sales offices, distributors and representatives, please visit:

www.ams.com/contact

Headquarters

ams AG

Tobelbader Strasse 30

8141 Premstaetten

Austria, Europe

Tel: +43 (0) 3136 500 0

Website: www.ams.com

RoHS Compliant & ams Green Statement

RoHS: The term RoHS compliant means that ams AG products fully comply with current RoHS directives. Our semiconductor products do not contain any chemicals for all 6 substance categories, including the requirement that lead not exceed 0.1% by weight in homogeneous materials. Where designed to be soldered at high temperatures, RoHS compliant products are suitable for use in specified lead-free processes.

ams Green (RoHS compliant and no Sb/Br): ams Green defines that in addition to RoHS compliance, our products are free of Bromine (Br) and Antimony (Sb) based flame retardants (Br or Sb do not exceed 0.1% by weight in homogeneous material).

Important Information: The information provided in this statement represents ams AG knowledge and belief as of the date that it is provided. ams AG bases its knowledge and belief on information provided by third parties, and makes no representation or warranty as to the accuracy of such information. Efforts are underway to better integrate information from third parties. ams AG has taken and continues to take reasonable steps to provide representative and accurate information but may not have conducted destructive testing or chemical analysis on incoming materials and chemicals. ams AG and ams AG suppliers consider certain information to be proprietary, and thus CAS numbers and other limited information may not be available for release.

Copyrights & Disclaimer

Copyright ams AG, Tobelbader Strasse 30, 8141 Premstaetten, Austria-Europe. Trademarks Registered. All rights reserved. The material herein may not be reproduced, adapted, merged, translated, stored, or used without the prior written consent of the copyright owner.

Devices sold by ams AG are covered by the warranty and patent indemnification provisions appearing in its General Terms of Trade. ams AG makes no warranty, express, statutory, implied, or by description regarding the information set forth herein. ams AG reserves the right to change specifications and prices at any time and without notice. Therefore, prior to designing this product into a system, it is necessary to check with ams AG for current information. This product is intended for use in commercial applications. Applications requiring extended temperature range, unusual environmental requirements, or high reliability applications, such as military, medical life-support or life-sustaining equipment are specifically not recommended without additional processing by ams AG for each application. This product is provided by ams AG "AS IS" and any express or implied warranties, including, but not limited to the implied warranties of merchantability and fitness for a particular purpose are disclaimed.

ams AG shall not be liable to recipient or any third party for any damages, including but not limited to personal injury, property damage, loss of profits, loss of use, interruption of business or indirect, special, incidental or consequential damages, of any kind, in connection with or arising out of the furnishing, performance or use of the technical data herein. No obligation or liability to recipient or any third party shall arise or flow out of ams AG rendering of technical or other services.

Document Status

Document Status	Product Status	Definition
Product Preview	Pre-Development	Information in this datasheet is based on product ideas in the planning phase of development. All specifications are design goals without any warranty and are subject to change without notice
Preliminary Datasheet	Pre-Production	Information in this datasheet is based on products in the design, validation or qualification phase of development. The performance and parameters shown in this document are preliminary without any warranty and are subject to change without notice
Datasheet	Production	Information in this datasheet is based on products in ramp-up to full production or full production which conform to specifications in accordance with the terms of ams AG standard warranty as given in the General Terms of Trade
Datasheet (discontinued)	Discontinued	Information in this datasheet is based on products which conform to specifications in accordance with the terms of ams AG standard warranty as given in the General Terms of Trade, but these products have been superseded and should not be used for new designs

Revision Information

Changes from 1-02 (2015-May-14) to current revision 1-03 (2017-May-26)	Page
Updated notes under Figure 99	91

Note(s):

1. Page and figure numbers for the previous version may differ from page and figure numbers in the current revision.
2. Correction of typographical errors is not explicitly mentioned.

Content Guide

1	General Description
2	Key Benefits & Features
2	Applications
3	Block Diagram
4	Pin Assignment
4	Pin Description
5	Absolute Maximum Ratings
6	Electrical Characteristics
11	Timing Characteristics
11	Timing Diagram
12	Typical Operating Characteristics
17	I²C Protocol
17	I ² C Write Transaction
17	I ² C Read Transaction
20	Detailed Description
20	Sleep After Interrupt Operation
21	Register Description
25	Enable Register (ENABLE 0x80)
26	ALS Integration Time Register (ATIME 0x81)
27	Proximity Sample Time Register (PTIME 0x82)
28	Wait Time Register (WTIME 0x83)
29	ALS Interrupt Threshold Registers (0x84 – 0x87)
30	Proximity Interrupt Threshold Registers (0x88 – 0x8B)
31	Interrupt Persistence Register (PERS 0x8C)
32	Configuration Register Zero (CFG0 0x8D)
33	Proximity/Gesture Configuration Register Zero (PGCFG0 0x8E)
34	Proximity/Gesture Configuration Register One (PGCFG1 0x8F)
35	Configuration Register One (CFG1 0x90)
36	Revision ID Register (REVID 0x91)
36	ID Register (ID 0x92)
37	Status Register (STATUS 0x93)
38	CRGB Data Registers (0x94 – 0x9B)
39	Proximity Data Registers (0x9C – 0x9D)
40	Status Register Two (STATUS2 0x9E)
41	Configuration Register Two (CFG2 0x9F)
42	IRBeam Configuration Register (ICONFIG 0xA0)
43	IRBeam Configuration Register Two (ICONFIG2 0xA1)
44	IRBeam Symbol Looping Register (ISNL 0xA2)
44	IRBeam Inter-Symbol OFF Register (ISOFF 0xA3)
45	IRBeam Packet Looping Register (IPNL 0xA4)
45	IRBeam Inter-Packet OFF Register (IPOFF 0xA5)
46	IRBeam Bit Time Register (IBT 0xA6)

46	IRBeam Symbol Length Register (ISLEN 0xA7)
47	IRBeam Status Register (ISTATUS 0xA8)
47	IRBeam Start Register (ISTART 0xA9)
48	Configuration Register Three (CFG3 0xAB)
49	Configuration Register Four (CFG4 0xAC)
50	Configuration Register Five (CFG5 0xAD)
51	Gesture Configuration Register Zero (GCFG0 0xB0)
52	Gesture Configuration Register One (GCFG1 0xB1)
53	Gesture Configuration Register Two (GCFG2 0xB2)
54	Status Register Three (STATUS3 0xB3)
54	Gesture Sample Time Register (GTIME 0xB4)
55	Gesture Control Register (GST_CTRL 0xB5)
55	Gesture Threshold Registers (0xB6 – 0xB9)
56	Gesture FIFO Buffer Level Register (GFIFO_LVL 0xBA)
56	Gesture Status Register (GSTATUS 0xBB)
57	Control Register (CONTROL 0xBC)
57	Auxiliary ID Register (AUXID 0xBD)
58	Proximity/Gesture Offset Registers (0xC0 – 0xC7)
59	Proximity/Gesture Baseline Registers (0xD0 – 0xD3)
60	Autozero Configuration Register (AZ_CONFIG 0xD6)
61	Calibration Register (CALIB 0xD7)
62	Calibration Configuration Register Zero (CALIBCFG0 0xD8)
64	Calibration Configuration Register One (CALIBCFG1 0xD9)
65	Calibration Configuration Register Two (CALIBCFG2 0xDA)
66	Calibration Configuration Register Three (CALIBCFG3 0xDB)
67	Calibration Status Register (CALIBSTAT 0xDC)
68	Interrupt Enable Register (INTENAB 0xDD)
69	Interrupt Clear Register (INTCLEAR 0xDE)
70	Gesture FIFO Access Registers (0xF8 – 0xFF)
72	Application Information
74	Remote Control
74	General Description of RC Functionality
74	Detailed Descriptions of RC Functionality
75	Block Diagram of Remote Control Functionality
76	Pattern RAM
78	Timeword RAM
79	Control Registers
82	Digital Logic
87	Electrical and Optical Output
88	Example Waveform and Device Setup
90	Protocol Accommodation Checklist

- 91 Package Drawings & Markings**
- 92 PCB Pad Layout**
- 93 Mechanical Data**

- 94 Soldering and Storage Information**
- 94 Soldering Information
- 95 Storage Information
- 95 Moisture Sensitivity
- 95 Shelf Life
- 95 Floor Life
- 95 Rebaking Instructions

- 96 Ordering & Contact Information**
- 97 RoHS Compliant & ams Green Statement**
- 98 Copyrights & Disclaimer**
- 99 Document Status**
- 100 Revision Information**