

# Switch-mode Power Rectifier

## DPAK Surface Mount Package



ON Semiconductor®

[www.onsemi.com](http://www.onsemi.com)

# MURD320, NRVUD320, SURD8320

These state-of-the-art devices are designed for use in switching power supplies, inverters and as free wheeling diodes.

### Features

- Ultrafast 35 Nanosecond Recovery Time
- Low Forward Voltage Drop
- Low Leakage
- NRVUD, SURD8 Prefixes for Automotive and Other Applications Requiring Unique Site and Control Change Requirements; AEC-Q101 Qualified and PPAP Capable
- These Devices are Pb-Free and are RoHS Compliant\*

### Mechanical Characteristics

- Case: Epoxy, Molded
- Weight: 0.4 Gram (Approximately)
- Finish: All External Surfaces Corrosion Resistant and Terminal Leads are Readily Solderable
- Lead and Mounting Surface Temperature for Soldering Purposes: 260°C Max. for 10 Seconds
- ESD Ratings:
  - ◆ Machine Model = C (> 400 V)
  - ◆ Human Body Model = 3B (> 8 kV)

### MAXIMUM RATINGS

| Rating   | Symbol                          | Value       | Unit |
|--|---------------------------------|-------------|------|
| Peak Repetitive Reverse Voltage<br>Working Peak Reverse Voltage<br>DC Blocking Voltage           | $V_{RRM}$<br>$V_{RWM}$<br>$V_R$ | 200         | V    |
| Average Rectified Forward Current<br>( $T_C = 158^\circ\text{C}$ )                               | $I_{F(AV)}$                     | 3.0         | A    |
| Peak Repetitive Forward Current<br>(Square Wave, Duty = 0.5,<br>$T_C = 158^\circ\text{C}$ )      | $I_{FRM}$                       | 6.0         | A    |
| Non-Repetitive Peak Surge Current<br>(Surge Applied at Rated Load<br>Conditions Halfwave, 60 Hz) | $I_{FSM}$                       | 75          | A    |
| Operating Junction and Storage<br>Temperature Range  | $T_J, T_{stg}$                  | -65 to +175 | °C   |

Stresses exceeding those listed in the Maximum Ratings table may damage the device. If any of these limits are exceeded, device functionality should not be assumed, damage may occur and reliability may be affected.

## ULTRAFAST RECTIFIER 3.0 AMPERES, 200 VOLTS

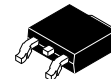

DPAK  
CASE 369C

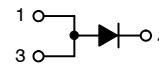

STYLE 3

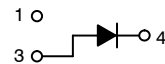

STYLE 8

### MARKING DIAGRAM

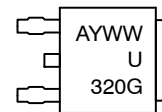

MURD320T4G  
SURD8320T4G  
NRVUD320VT4G

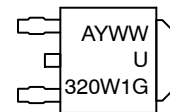

NRVUD320W1T4G

- A = Assembly Location\*\*
- Y = Year
- WW = Work Week
- G = Pb-Free Package

\*\*The Assembly Location Code (A) is front side optional. In cases where the Assembly Location is stamped in the package bottom (molding ejector pin), the front side assembly code may be blank.

### ORDERING INFORMATION

| Device             | Package           | Shipping†          |
|--------------------|-------------------|--------------------|
| MURD320T4G         | DPAK<br>(Pb-Free) | 2500 / Tape & Reel |
| NRVUD320VT4G       | DPAK<br>(Pb-Free) | 2500 / Tape & Reel |
| NRVUD320W1T4G      | DPAK<br>(Pb-Free) | 2500 / Tape & Reel |
| NRVUD320W1T4G-VF01 | DPAK<br>(Pb-Free) | 2500 / Tape & Reel |
| SURD8320T4G        | DPAK<br>(Pb-Free) | 2500 / Tape & Reel |

†For information on tape and reel specifications, including part orientation and tape sizes, please refer to our Tape and Reel Packaging Specifications Brochure, BRD8011/D.

# MURD320, NRVUD320, SURD8320

## THERMAL CHARACTERISTICS

| Characteristics                                   | Symbol          | Value | Unit          |
|---|-----------------|-------|---------------|
| Thermal Resistance – Junction-to-Case             | $R_{\theta JC}$ | 6     | $^{\circ}C/W$ |
| Thermal Resistance – Junction-to-Ambient (Note 1) | $R_{\theta JA}$ | 80    | $^{\circ}C/W$ |

1. Rating applies when surface mounted on the minimum pad sizes recommended.

## ELECTRICAL CHARACTERISTICS

| Characteristics   | Symbol   | Value        | Unit    |
|---|----------|--------------|---------|
| Maximum Instantaneous Forward Voltage Drop (Note 2)<br>( $i_F = 3$ Amps, $T_J = 25^{\circ}C$ )<br>( $i_F = 3$ Amps, $T_J = 125^{\circ}C$ )  | $V_F$    | 0.95<br>0.75 | Volts   |
| Maximum Instantaneous Reverse Current (Note 2)<br>( $T_J = 25^{\circ}C$ , Rated dc Voltage)<br>( $T_J = 125^{\circ}C$ , Rated dc Voltage)   | $i_R$    | 5<br>500     | $\mu A$ |
| Maximum Reverse Recovery Time<br>( $I_F = 1$ Amp, $di/dt = 50$ Amps/ $\mu s$ , $V_R = 30$ V, $T_J = 25^{\circ}C$ )<br>( $I_F = 0.5$ Amp, $i_R = 1$ Amp, $I_{REC} = 0.25$ A, $V_R = 30$ V, $T_J = 25^{\circ}C$ ) | $t_{rr}$ | 35<br>25     | ns      |

Product parametric performance is indicated in the Electrical Characteristics for the listed test conditions, unless otherwise noted. Product performance may not be indicated by the Electrical Characteristics if operated under different conditions.

2. Pulse Test: Pulse Width = 300  $\mu s$ , Duty Cycle  $\leq 2.0\%$ .

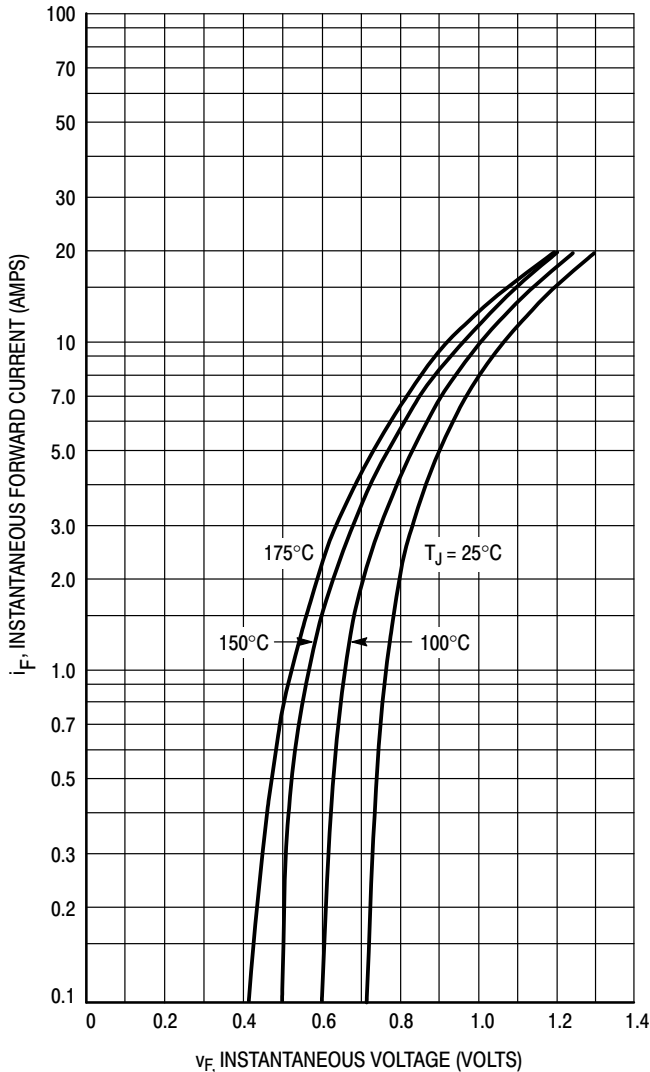

Figure 1. Typical Forward Voltage

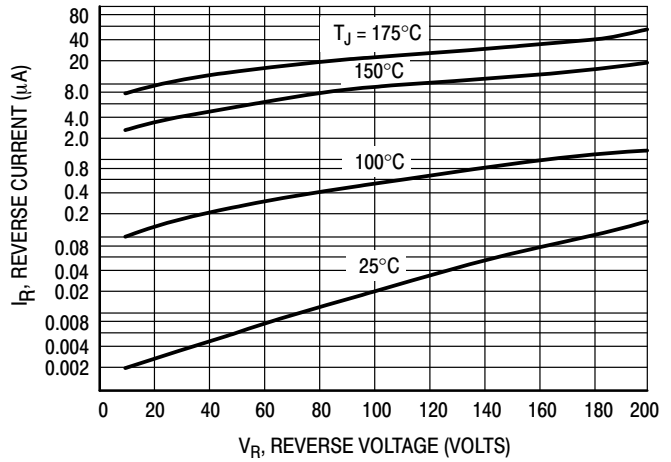

Figure 2. Typical Reverse Current\*

\* The curves shown are typical for the highest voltage device in the voltage grouping. Typical reverse current for lower voltage selections can be estimated from these curves if  $V_R$  is sufficiently below rated  $V_R$ .

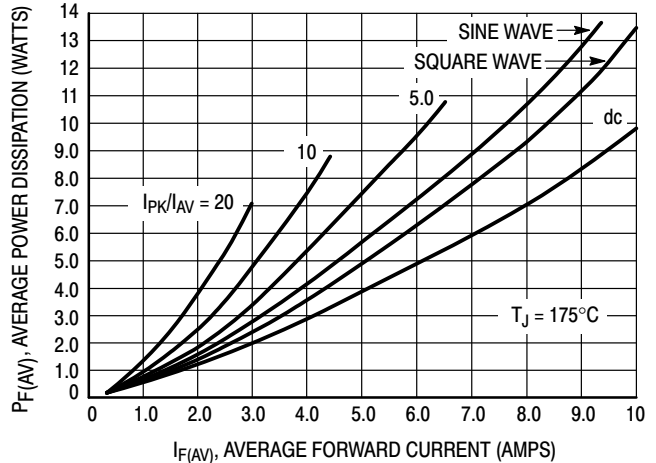

Figure 3. Average Power Dissipation

# MURD320, NRVUD320, SURD8320

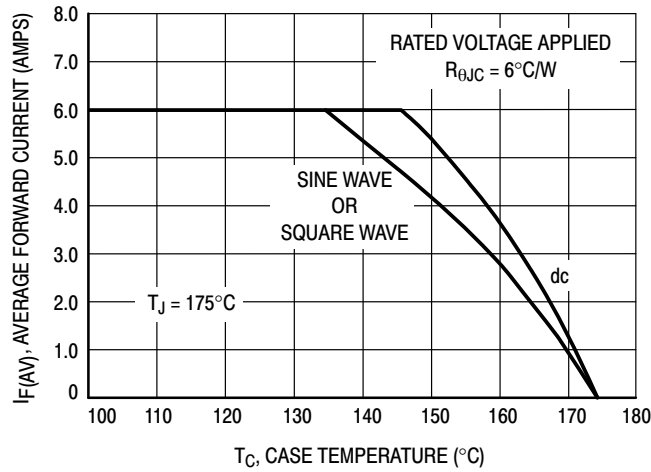

Figure 4. Current Derating, Case

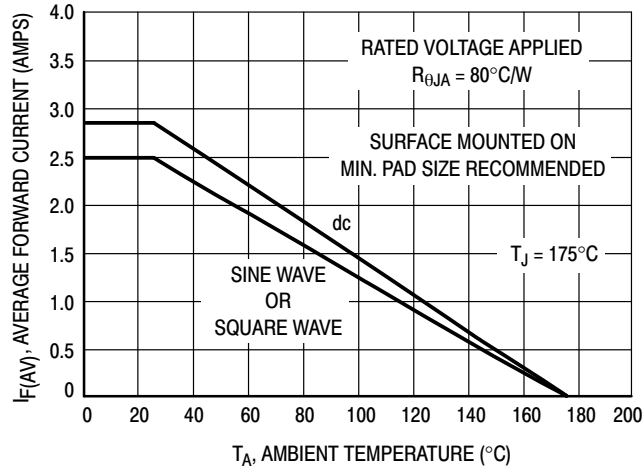

Figure 5. Current Derating, Ambient

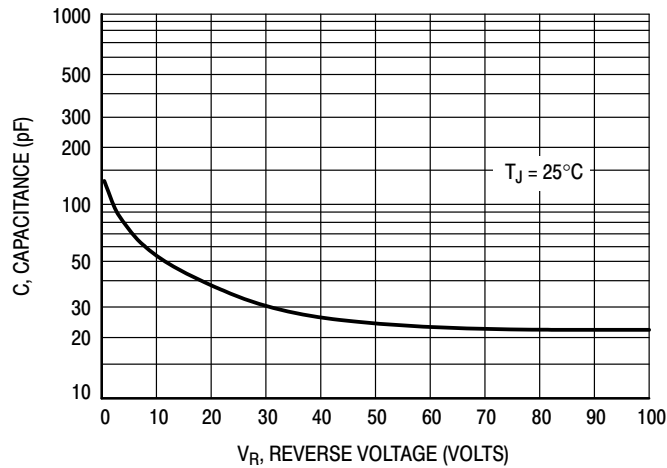

Figure 6. Typical Capacitance

# MECHANICAL CASE OUTLINE PACKAGE DIMENSIONS



## DPAK (SINGLE GAUGE) CASE 369C ISSUE G

DATE 31 MAY 2023

SCALE 1:1

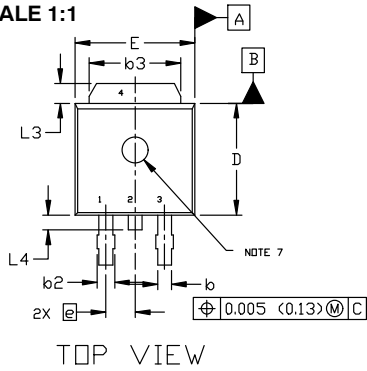

TOP VIEW

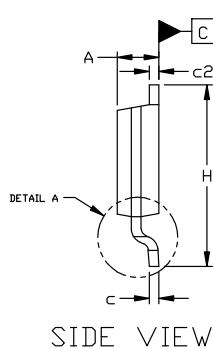

SIDE VIEW

NOTES:

1. DIMENSIONING AND TOLERANCING ASME Y14.5M, 1994.
2. CONTROLLING DIMENSION: INCHES
3. THERMAL PAD CONTOUR OPTIONAL WITHIN DIMENSIONS b3, L3, AND Z.
4. DIMENSIONS D AND E DO NOT INCLUDE MOLD FLASH, PROTRUSIONS, OR BURRS. MOLD FLASH, PROTRUSIONS, OR GATE BURRS SHALL NOT EXCEED 0.006 INCHES PER SIDE.
5. DIMENSIONS D AND E ARE DETERMINED AT THE OUTERMOST EXTREMES OF THE PLASTIC BODY.
6. DATUMS A AND B ARE DETERMINED AT DATUM PLANE H.
7. OPTIONAL MOLD FEATURE.

| DIM | INCHES |       | MILLIMETERS |       |
|-----|--------|-------|-------------|-------|
|     | MIN.   | MAX.  | MIN.        | MAX.  |
| A   | 0.086  | 0.094 | 2.18        | 2.38  |
| A1  | 0.000  | 0.005 | 0.00        | 0.13  |
| b   | 0.025  | 0.035 | 0.63        | 0.89  |
| b2  | 0.028  | 0.045 | 0.72        | 1.14  |
| b3  | 0.180  | 0.215 | 4.57        | 5.46  |
| c   | 0.018  | 0.024 | 0.46        | 0.61  |
| c2  | 0.018  | 0.024 | 0.46        | 0.61  |
| D   | 0.235  | 0.245 | 5.97        | 6.22  |
| E   | 0.250  | 0.265 | 6.35        | 6.73  |
| e   | 0.090  | BSC   | 2.29        | BSC   |
| H   | 0.370  | 0.410 | 9.40        | 10.41 |
| L   | 0.055  | 0.070 | 1.40        | 1.78  |
| L1  | 0.114  | REF   | 2.90        | REF   |
| L2  | 0.020  | BSC   | 0.51        | BSC   |
| L3  | 0.035  | 0.050 | 0.89        | 1.27  |
| L4  | ----   | 0.040 | ---         | 1.01  |
| Z   | 0.155  | ----  | 3.93        | ---   |

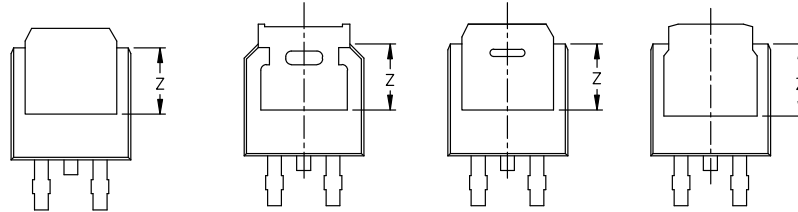

BOTTOM VIEW

BOTTOM VIEW

ALTERNATE CONSTRUCTIONS

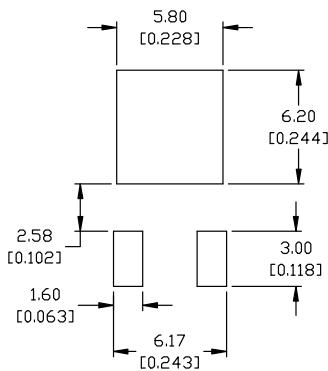

### RECOMMENDED MOUNTING FOOTPRINT\*

\*FOR ADDITIONAL INFORMATION ON OUR Pb-FREE STRATEGY AND SOLDERING DETAILS, PLEASE DOWNLOAD THE ON SEMICONDUCTOR SOLDERING AND MOUNTING TECHNIQUES REFERENCE MANUAL, SOLDERRM/D.

- |  |  |   |   |  |
|--|--|---|---|--|
| <p>STYLE 1:<br/>PIN 1. BASE<br/>2. COLLECTOR<br/>3. EMITTER<br/>4. COLLECTOR</p> | <p>STYLE 2:<br/>PIN 1. GATE<br/>2. DRAIN<br/>3. SOURCE<br/>4. DRAIN</p>          | <p>STYLE 3:<br/>PIN 1. ANODE<br/>2. CATHODE<br/>3. ANODE<br/>4. CATHODE</p> | <p>STYLE 4:<br/>PIN 1. CATHODE<br/>2. ANODE<br/>3. GATE<br/>4. ANODE</p>              | <p>STYLE 5:<br/>PIN 1. GATE<br/>2. ANODE<br/>3. CATHODE<br/>4. ANODE</p>     |
| <p>STYLE 6:<br/>PIN 1. MT1<br/>2. MT2<br/>3. GATE<br/>4. MT2</p>                 | <p>STYLE 7:<br/>PIN 1. GATE<br/>2. COLLECTOR<br/>3. EMITTER<br/>4. COLLECTOR</p> | <p>STYLE 8:<br/>PIN 1. N/C<br/>2. CATHODE<br/>3. ANODE<br/>4. CATHODE</p>   | <p>STYLE 9:<br/>PIN 1. ANODE<br/>2. CATHODE<br/>3. RESISTOR ADJUST<br/>4. CATHODE</p> | <p>STYLE 10:<br/>PIN 1. CATHODE<br/>2. ANODE<br/>3. CATHODE<br/>4. ANODE</p> |

### GENERIC MARKING DIAGRAM\*

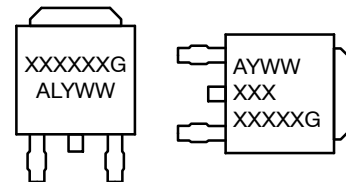

IC

Discrete

- XXXXXX = Device Code
- A = Assembly Location
- L = Wafer Lot
- Y = Year
- WW = Work Week
- G = Pb-Free Package

\*This information is generic. Please refer to device data sheet for actual part marking. Pb-Free indicator, "G" or microdot "•", may or may not be present. Some products may not follow the Generic Marking.

|                         |                            |  |
|-------------------------|----------------------------|--|
| <b>DOCUMENT NUMBER:</b> | <b>98AON10527D</b>         | Electronic versions are uncontrolled except when accessed directly from the Document Repository. Printed versions are uncontrolled except when stamped "CONTROLLED COPY" in red. |
| <b>DESCRIPTION:</b>     | <b>DPAK (SINGLE GAUGE)</b> | <b>PAGE 1 OF 1</b>   |

onsemi and onsemi are trademarks of Semiconductor Components Industries, LLC dba onsemi or its subsidiaries in the United States and/or other countries. onsemi reserves the right to make changes without further notice to any products herein. onsemi makes no warranty, representation or guarantee regarding the suitability of its products for any particular purpose, nor does onsemi assume any liability arising out of the application or use of any product or circuit, and specifically disclaims any and all liability, including without limitation special, consequential or incidental damages. onsemi does not convey any license under its patent rights nor the rights of others.

**onsemi**, **Onsemi**, and other names, marks, and brands are registered and/or common law trademarks of Semiconductor Components Industries, LLC dba "**onsemi**" or its affiliates and/or subsidiaries in the United States and/or other countries. **onsemi** owns the rights to a number of patents, trademarks, copyrights, trade secrets, and other intellectual property. A listing of **onsemi**'s product/patent coverage may be accessed at [www.onsemi.com/site/pdf/Patent-Marking.pdf](http://www.onsemi.com/site/pdf/Patent-Marking.pdf). **onsemi** reserves the right to make changes at any time to any products or information herein, without notice. The information herein is provided "as-is" and **onsemi** makes no warranty, representation or guarantee regarding the accuracy of the information, product features, availability, functionality, or suitability of its products for any particular purpose, nor does **onsemi** assume any liability arising out of the application or use of any product or circuit, and specifically disclaims any and all liability, including without limitation special, consequential or incidental damages. Buyer is responsible for its products and applications using **onsemi** products, including compliance with all laws, regulations and safety requirements or standards, regardless of any support or applications information provided by **onsemi**. "Typical" parameters which may be provided in **onsemi** data sheets and/or specifications can and do vary in different applications and actual performance may vary over time. All operating parameters, including "Typicals" must be validated for each customer application by customer's technical experts. **onsemi** does not convey any license under any of its intellectual property rights nor the rights of others. **onsemi** products are not designed, intended, or authorized for use as a critical component in life support systems or any FDA Class 3 medical devices or medical devices with a same or similar classification in a foreign jurisdiction or any devices intended for implantation in the human body. Should Buyer purchase or use **onsemi** products for any such unintended or unauthorized application, Buyer shall indemnify and hold **onsemi** and its officers, employees, subsidiaries, affiliates, and distributors harmless against all claims, costs, damages, and expenses, and reasonable attorney fees arising out of, directly or indirectly, any claim of personal injury or death associated with such unintended or unauthorized use, even if such claim alleges that **onsemi** was negligent regarding the design or manufacture of the part. **onsemi** is an Equal Opportunity/Affirmative Action Employer. This literature is subject to all applicable copyright laws and is not for resale in any manner.

## ADDITIONAL INFORMATION

### TECHNICAL PUBLICATIONS:

Technical Library: [www.onsemi.com/design/resources/technical-documentation](http://www.onsemi.com/design/resources/technical-documentation)  
onsemi Website: [www.onsemi.com](http://www.onsemi.com)

### ONLINE SUPPORT: [www.onsemi.com/support](http://www.onsemi.com/support)

For additional information, please contact your local Sales Representative at [www.onsemi.com/support/sales](http://www.onsemi.com/support/sales)