

DDR SDRAM TERMINATOR TECHNICAL DATA SHEET

FEATURES

- 18 Bit SSTL_2 Termination Sets
- Compliant to JEDEC Standard 8-9A
- Excellent High Frequency Performance
- Slim BGA Package
- 1% Resistor Tolerance
- Low Channel Capacitance
- Tape and Reel Packaging
- RoHS Compliant Designs Available
 - Compatible with both lead and lead-free manufacturing processes
- **RoHS Compliant in Accordance with EU Directive 2011/65/EU**
 - Lead-Free Termination Finish
 - Exemption 7(c)-1, Electrical and electronic components containing lead [Pb] in glass

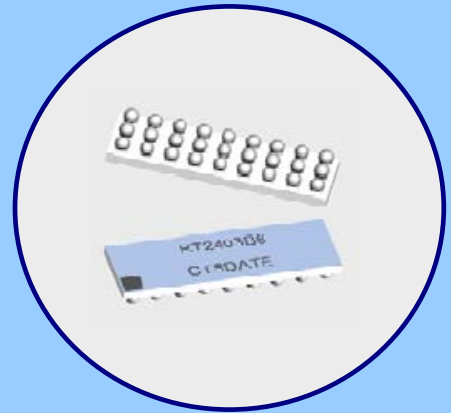

DESCRIPTION

This SSTL_2 terminator network provides high performance resistor termination for SSTL_2 Class I or Class II systems. Designed with a ceramic substrate, this device minimizes channel capacitance, a primary cause of reduced system performance. In addition, the BGA package eases routing design, saving the designer many hours of printed circuit layout. The BGA packaging has been proved to reduce rework and improve reliability.

ORDERING INFORMATION

| 1.27mm PITCH NON-RoHS PART NUMBER | 1.00mm PITCH NON-RoHS PART NUMBER | CIRCUIT STYLE | R1 [Ohms] | R2 [Ohms] | ARRAY SIZE | 1.27mm PITCH RoHS PART NUMBER | 1.00mm PITCH RoHS PART NUMBER |
|---|---|------------------|--------------|--------------|---------------|-------------------------------------|-------------------------------------|
| RT1400B6 * | RT1400B7 * | H | 50 | 25 | 3 x 9 | RT2400B6 * | RT2400B7 * |
| RT1401B6 | RT1401B7 | H | 25 | 22 | 3 x 9 | RT2401B6 | RT2401B7 |
| RT1402B6 * | RT1402B7 * | F | 50 | - | 3 x 9 | RT2402B6 * | RT2402B7 * |
| RT1403B6 * | RT1403B7 * | F | 25 | - | 3 x 9 | RT2403B6 * | RT2403B7 * |
| RT1404B6 * | RT1404B7 * | C | 25 | - | 4 x 9 | RT2404B6 * | RT2404B7 * |
| RT1405B6 * | RT1405B7 * | C | 22 | - | 4 x 9 | RT2405B6 * | RT2405B7 * |
| RT1407B6 * | RT1407B7 * | F | 35 | - | 3 x 9 | RT2407B6 * | RT2407B7 * |
| RT1408B6 * | RT1408B7 * | H | 60 | 25 | 3 x 9 | RT2408B6 * | RT2408B7 * |
| RT1409B6 | RT1409B7 | C | 120 | - | 4 x 9 | RT2409B6 | RT2409B7 |
| RT1410B6 | RT1410B7 | F | 100,000 | - | 3 x 9 | RT2410B6 | RT2410B7 |
| RT1430B6 | RT1430B7 | F | 60 | - | 3 x 9 | RT2430B6 | RT2430B7 |
| RT1432B6 | RT1432B7 | F | 120 | - | 3 x 9 | RT2432B6 | RT2432B7 |
| RT1460B6 | RT1460B7 | C | 50 | - | 4 x 9 | RT2460B6 | RT2460B7 |
| RT1463B6 * | RT1463B7 | C | 33 | - | 4 x 9 | RT2463B6 * | RT2463B7 |
| RT1465B6 | RT1465B7 | C | 47 | - | 4 x 9 | RT2465B6 | RT2465B7 |
| RT1467B6 * | RT1467B7 * | F | 75 | - | 3 x 9 | RT2467B6 * | RT2467B7 * |
| RT1468B6 * | RT1468B7 * | F | 150 | - | 3 x 9 | RT2468B6 * | RT2468B7 * |

* Indicates available Top Probe-able part numbers.

Refer to the following link for detailed Top Side Probe-able information: www.ctscorp.com/components/clearone/TopProveClearOne.pdf

TAPE & REEL INFORMATION

| SUFFIX | TR7 | TR13 |
|---------------|-------|--------|
| Tape Width | 24mm | 24mm |
| Carrier Pitch | 8mm | 8mm |
| Reel Diameter | 7inch | 13inch |
| Parts/Reel | 1,000 | 4,000 |

Part Number Coding

For 7inch reel, add TR7 to part number

Ex. RT2400B6TR7

For 13inch reel, add TR13 to part number

Ex. RT2400B6TR13

(Bulk packaging is not available)

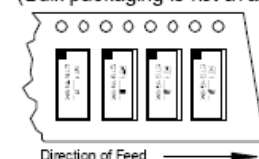

ELECTRICAL & ENVIRONMENTAL CHARACTERISTICS

| | |
|------------------------------------|--------------------------|
| Resistor Tolerance | ±1% |
| TCR | ±200ppm/°C |
| Operating Temperature Range | -55°C to +125°C |
| Maximum Resistor Power | 0.05 Watts at 70°C |
| Maximum Package Power | 1.0 Watts at 70°C |
| Process Requirements | |
| Maximum Re-flow Temperature | Per IPC/JEDEC J-STD-020C |

CIRCUIT TYPES

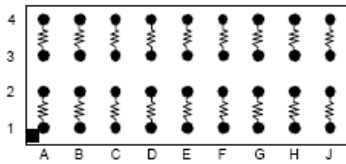

Style C

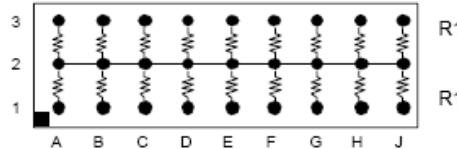

Style F

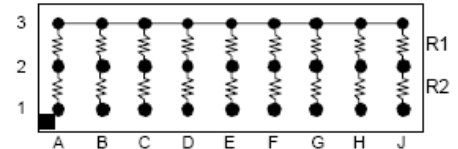

Style H

PACKAGE OUTLINES

| 1.27mm PITCH | | L | W | H | P | D | K |
|---------------------|------|--------------|--------------|--------------|--------------|--------------|--------------|
| Styles H & F | mm | 11.43 ±0.15 | 3.81 ±0.15 | 1.32 ±0.15 | 1.27 ±0.25 | 0.76 ±0.05 | 0.64 ±0.25 |
| | inch | 0.450 ±0.006 | 0.150 ±0.006 | 0.052 ±0.006 | 0.050 ±0.010 | 0.030 ±0.002 | 0.025 ±0.010 |
| 1.00mm PITCH | | L | W | H | P | D | K |
| Styles H & F | mm | 9.00 ±0.15 | 3.00 ±0.15 | 1.19 ±0.15 | 1.00 ±0.25 | 0.64 ±0.05 | 0.50 ±0.25 |
| | inch | 0.354 ±0.006 | 0.118 ±0.006 | 0.047 ±0.006 | 0.039 ±0.010 | 0.025 ±0.002 | 0.020 ±0.010 |

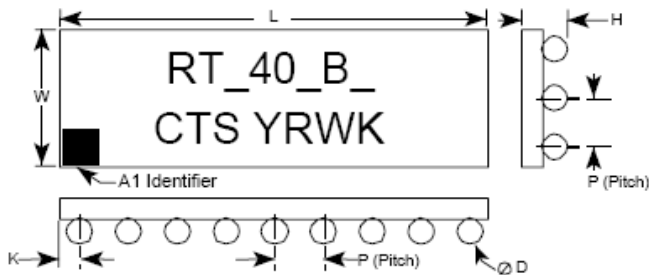

| 1.27mm PITCH | | L | W | H | P | D | K |
|---------------------|------|--------------|--------------|--------------|--------------|--------------|--------------|
| Style C | mm | 11.43 ±0.15 | 5.08 ±0.15 | 1.32 ±0.15 | 1.27 ±0.25 | 0.76 ±0.05 | 0.64 ±0.25 |
| | inch | 0.450 ±0.006 | 0.200 ±0.006 | 0.052 ±0.006 | 0.050 ±0.010 | 0.030 ±0.002 | 0.025 ±0.010 |
| 1.00mm PITCH | | L | W | H | P | D | K |
| Style C | mm | 9.00 ±0.15 | 4.00 ±0.15 | 1.19 ±0.15 | 1.00 ±0.25 | 0.64 ±0.05 | 0.50 ±0.25 |
| | inch | 0.354 ±0.006 | 0.157 ±0.006 | 0.047 ±0.006 | 0.039 ±0.010 | 0.025 ±0.002 | 0.020 ±0.010 |

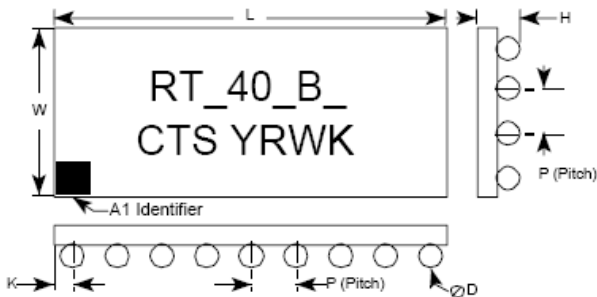

PACKAGE OUTLINES

LAND PATTERNS

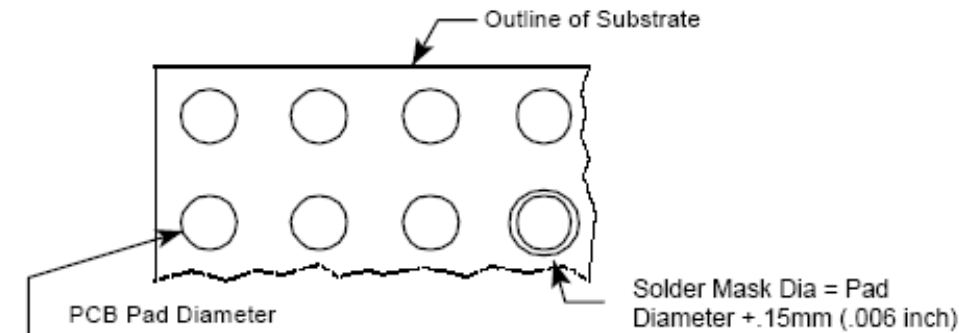

- ⊘ 1.00mm Pitch (B7) = 0.51mm/.020 inch (minimum)
- 1.27mm pitch (B6) = 0.64mm/.025 inch (minimum)

For .006" Thick Solder Paste Stencil, Aperture Opening Should be Equal to the PCB Pad Diameter.

Refer to www.ctscorp.com/components/clearone.asp for additional PCB design information

BGA Routing Schemes

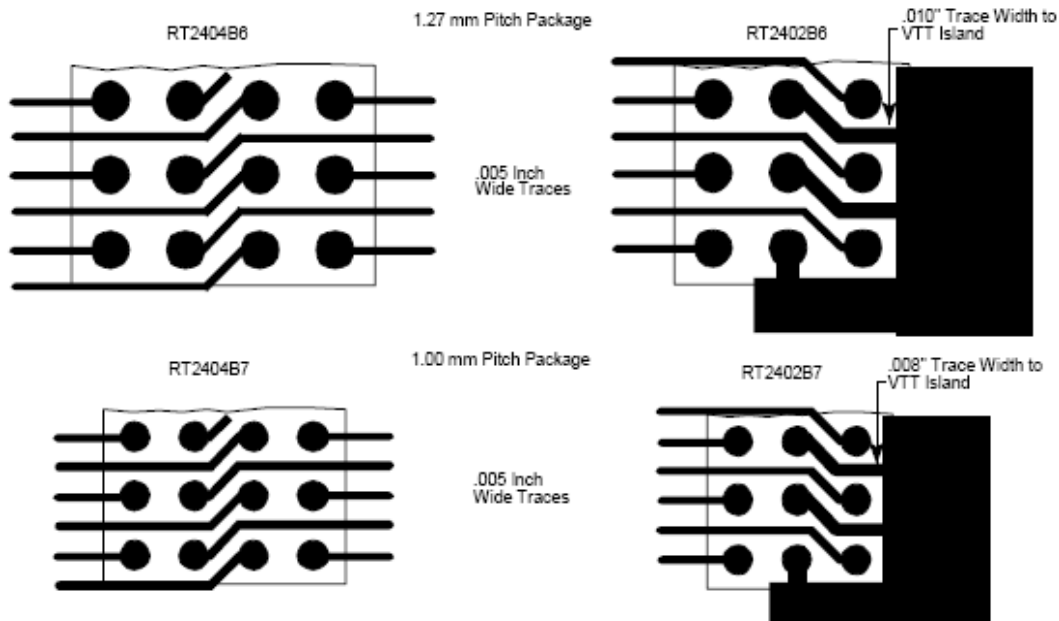

APPLICATIONS

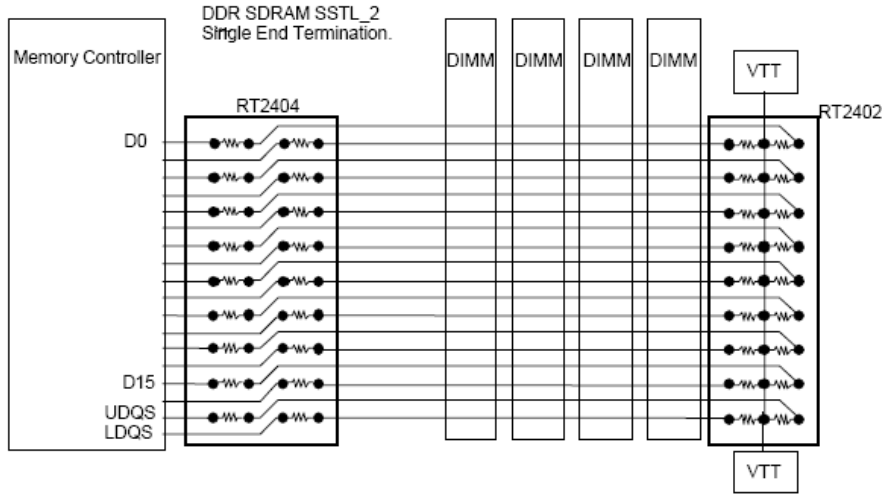
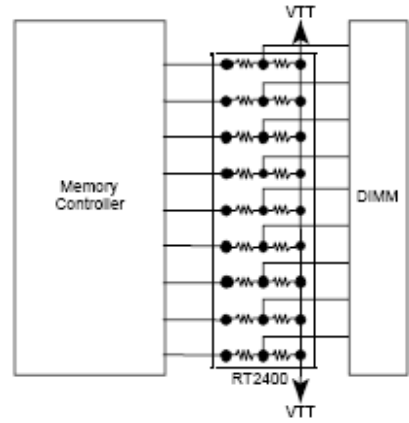
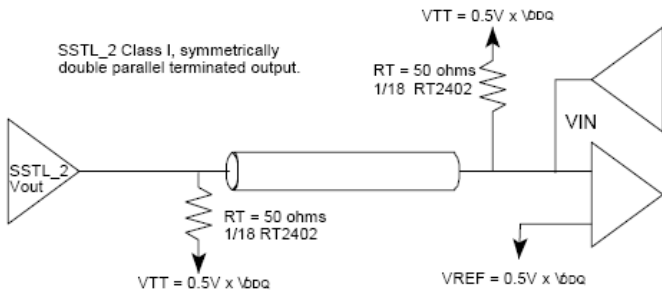
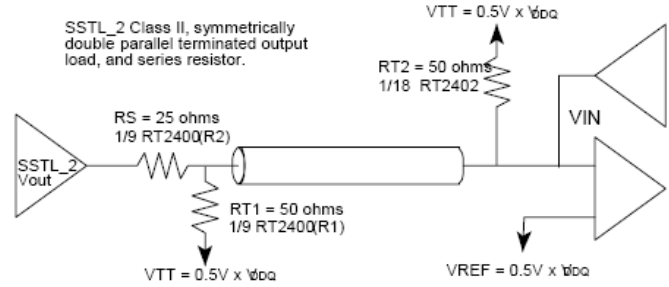
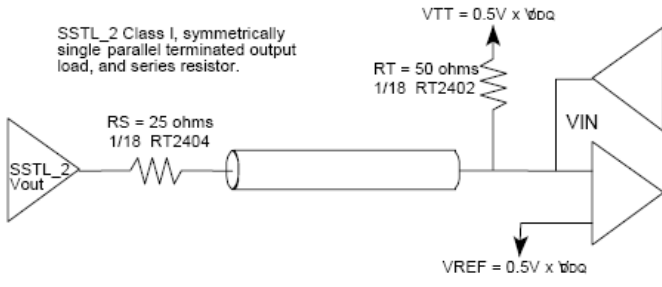

Complete ClearONE Product, Processing, and Application Information can be found at the following link:
<http://www.ctscorp.com/components/clearone.asp>

This product is covered by one or more of the following U.S. and foreign patents:
US 5,977,863; TW 133,148; US 6,005,777; US 6,194,979; TW 89104035; US 6,097,277; US 6,246,312; US 6,749,775; US 6,577,225; US 6,963,265;
US 6,897,761; US 6,882,266; US 6,946,733; US 6,856,516. Other U.S. and foreign patents pending.