

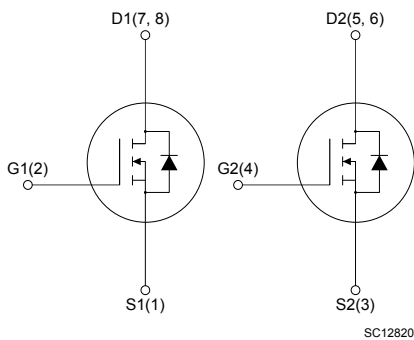

Automotive-grade dual N-channel 60 V, 35 mΩ typ., 5 A STripFET II Power MOSFET in an SO-8 package

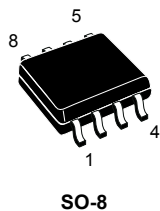

Features

Order code	V _{DS}	R _{DS(on)} max.	I _D
STS5DNF60L	60 V	45 mΩ	5 A

- AEC-Q101 qualified 
- Exceptional dv/dt capability
- 100% avalanche tested
- Low gate charge

Applications

- Switching applications

Description

This Power MOSFET has been developed using STMicroelectronics' unique STripFET process, which is specifically designed to minimize input capacitance and gate charge. This renders the device suitable for use as primary switch in advanced high-efficiency isolated DC-DC converters for telecom and computer applications, and applications with low gate charge driving requirements.



Product status link

[STS5DNF60L](#)

Product summary

Order code	STS5DNF60L
Marking	5DF60L
Package	SO-8
Packing	Tape and reel

1 Electrical ratings

Table 1. Absolute maximum ratings

Symbol	Parameter	Value	Unit
V_{DS}	Drain-source voltage	60	V
V_{GS}	Gate-source voltage	± 15	V
I_D	Drain current (continuous) at $T_{amb} = 25\text{ }^\circ\text{C}$	5	A
	Drain current (continuous) at $T_{amb} = 100\text{ }^\circ\text{C}$	3	A
$I_{DM}^{(1)}$	Drain current (pulsed)	16	A
$P_{TOT}^{(2)}$	Total power dissipation at $T_{amb} = 25\text{ }^\circ\text{C}$	2	W
T_{stg}	Storage temperature range	-55 to 150	$^\circ\text{C}$
T_J	Operating junction temperature range		$^\circ\text{C}$

1. Pulse width limited by safe operating area.
2. $P_{TOT} = 1.6\text{ W}$ for single operation.

Table 2. Thermal data

Symbol	Parameter	Value	Unit
$R_{thJB}^{(1)}$	Thermal resistance, junction-to-board	62.5	$^\circ\text{C/W}$

1. When mounted on 1 inch² FR-4 board, 2 Oz Cu, $t \leq 10\text{ s}$, dual operation.

2 Electrical characteristics

$T_C = 25\text{ °C}$ unless otherwise specified.

Table 3. On/off states

Symbol	Parameter	Test conditions	Min.	Typ.	Max.	Unit
$V_{(BR)DSS}$	Drain-source breakdown voltage	$V_{GS} = 0\text{ V}$, $I_D = 250\text{ }\mu\text{A}$	60			V
I_{DSS}	Zero gate voltage drain current	$V_{GS} = 0\text{ V}$, $V_{DS} = 60\text{ V}$			1	μA
		$V_{GS} = 0\text{ V}$, $V_{DS} = 60\text{ V}$, $T_C = 125\text{ °C}^{(1)}$			10	μA
I_{GSS}	Gate-body leakage current	$V_{DS} = 0\text{ V}$, $V_{GS} = \pm 15\text{ V}$			± 100	nA
$V_{GS(th)}$	Gate threshold voltage	$V_{DS} = V_{GS}$, $I_D = 250\text{ }\mu\text{A}$	1.0	1.7	2.5	V
$R_{DS(on)}$	Static drain-source on-resistance	$V_{GS} = 10\text{ V}$, $I_D = 2\text{ A}$		35	45	m Ω
		$V_{GS} = 4.5\text{ V}$, $I_D = 2\text{ A}$		45	55	

1. Defined by design, not subject to production test.

Table 4. Dynamic

Symbol	Parameter	Test conditions	Min.	Typ.	Max.	Unit
C_{iss}	Input capacitance	$V_{DS} = 25\text{ V}$, $f = 1\text{ MHz}$, $V_{GS} = 0\text{ V}$	-	1030	-	pF
C_{oss}	Output capacitance		-	140	-	pF
C_{rSS}	Reverse transfer capacitance		-	40	-	pF
Q_g	Total gate charge	$V_{DD} = 48\text{ V}$, $I_D = 4\text{ A}$, $V_{GS} = 4.5\text{ V}$ (see Figure 12. Test circuit for gate charge behavior)	-	15	-	nC
Q_{gs}	Gate-source charge		-	4	-	nC
Q_{gd}	Gate-drain charge		-	4	-	nC

Table 5. Switching times

Symbol	Parameter	Test conditions	Min.	Typ.	Max.	Unit
$t_{d(on)}$	Turn-on delay time	$V_{DD} = 30\text{ V}$, $I_D = 2.2\text{ A}$, $R_G = 4.7\text{ }\Omega$, $V_{GS} = 4.5\text{ V}$	-	15	-	ns
t_r	Rise time		-	28	-	ns
$t_{d(off)}$	Turn-off delay time	(see Figure 11. Test circuit for resistive load switching times and Figure 16. Switching time waveform)	-	45	-	ns
t_f	Fall time		-	10	-	ns

Table 6. Source-drain diode

Symbol	Parameter	Test conditions	Min.	Typ.	Max.	Unit
I_{SD}	Source-drain current		-		5	A
$I_{SDM}^{(1)}$	Source-drain current (pulsed)		-		16	A
$V_{SD}^{(2)}$	Forward on voltage	$I_{SD} = 4\text{ A}, V_{GS} = 0\text{ V}$	-		1.2	V
t_{rr}	Reverse recovery time	$I_{SD} = 4\text{ A}, di/dt = 100\text{ A}/\mu\text{s}, V_{DD} = 20\text{ V}$ (see Figure 16. Switching time waveform)	-	85		ns
Q_{rr}	Reverse recovery charge		-	85		nC
I_{RRM}	Reverse recovery current		-	2		A

1. Pulse width limited by safe operating area.
2. Pulsed: pulse duration = 300 μs , duty cycle 1.5%.

2.1 Electrical characteristics (curves)

Figure 1. Safe operating area

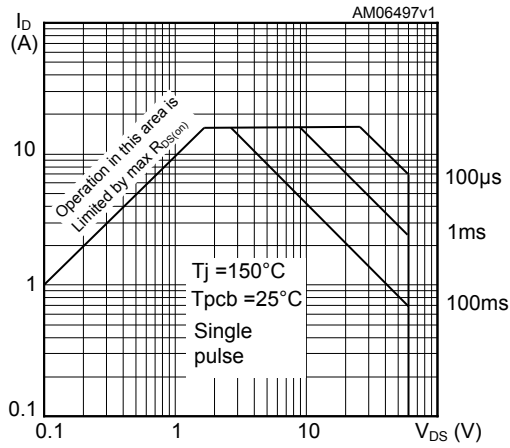

Figure 2. Thermal impedance

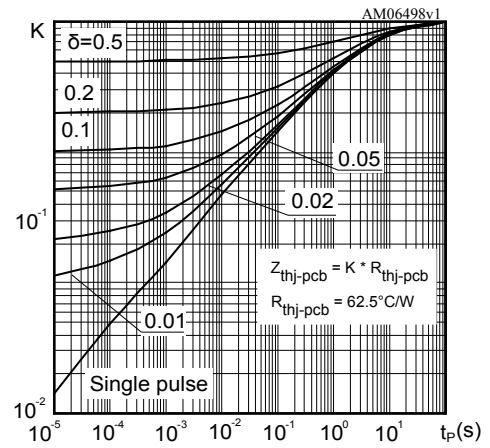

Figure 3. Output characteristics

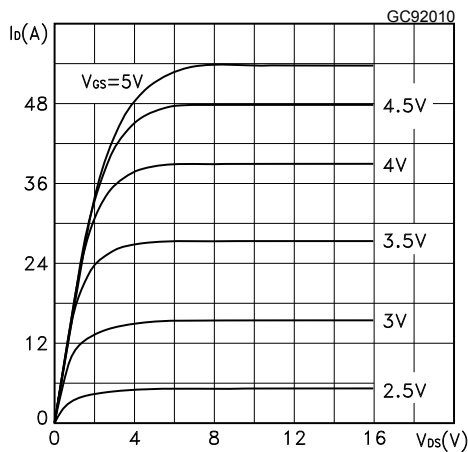

Figure 4. Transfer characteristics

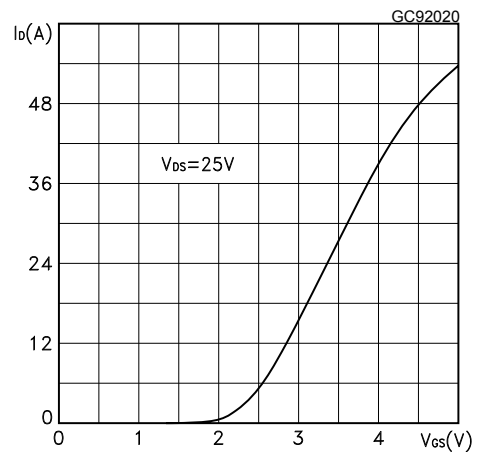

Figure 5. Source-drain diode forward characteristics

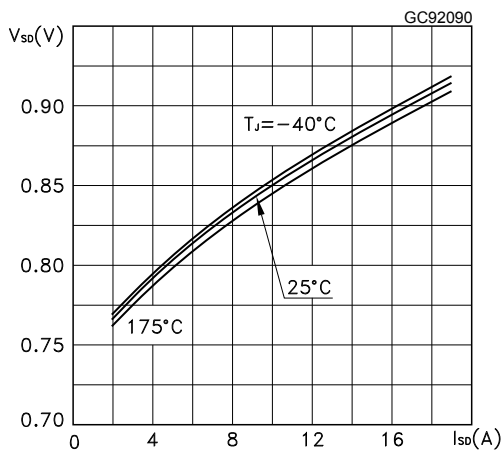

Figure 6. Static drain-source on-resistance

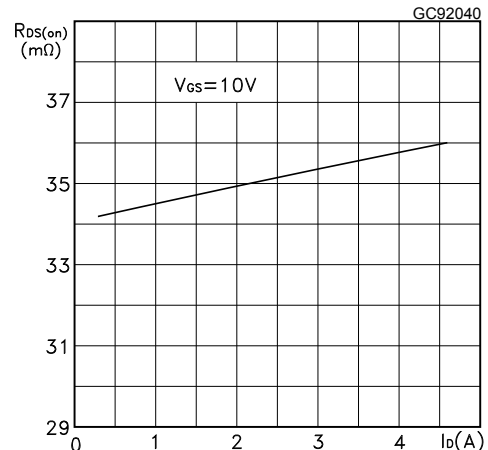

Figure 7. Gate charge vs gate-source voltage

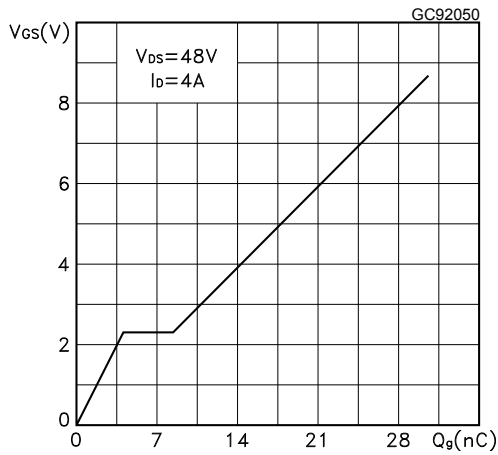

Figure 8. Capacitance variations

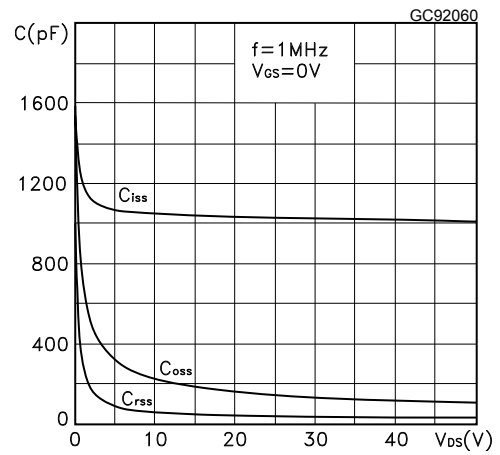

Figure 9. Normalized gate threshold voltage vs temperature

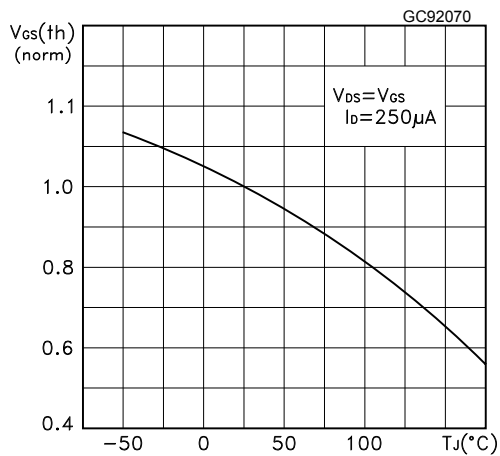
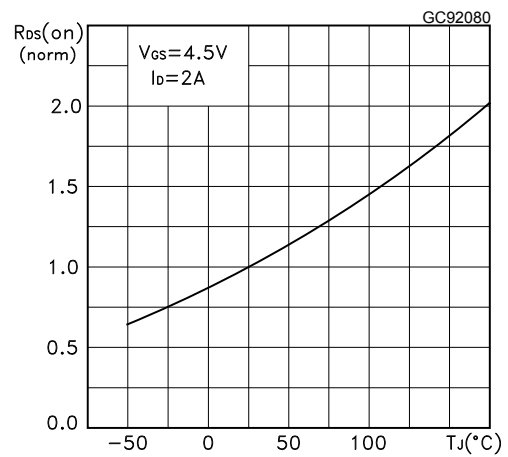
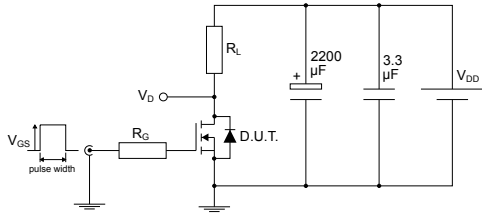

Figure 10. Normalized on-resistance vs temperature



3 Test circuits

Figure 11. Test circuit for resistive load switching times



AM01468v1

Figure 12. Test circuit for gate charge behavior

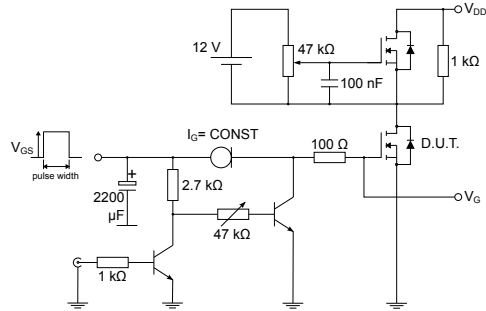

AM01469v1

Figure 13. Test circuit for inductive load switching and diode recovery times

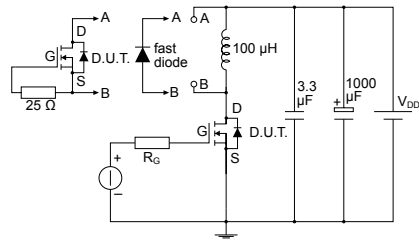

AM01470v1

Figure 14. Unclamped inductive load test circuit

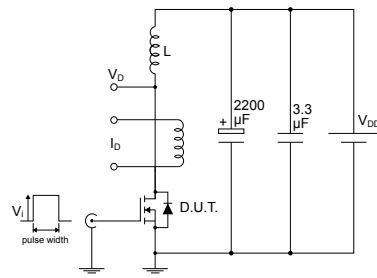

AM01471v1

Figure 15. Unclamped inductive waveform

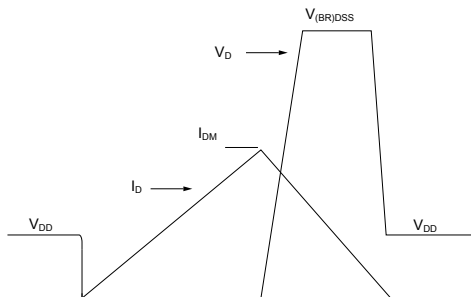

AM01472v1

Figure 16. Switching time waveform

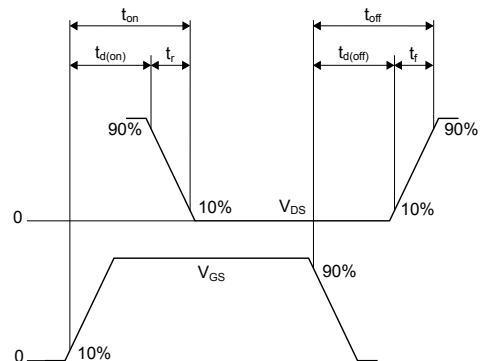

AM01473v1

4 Package information

In order to meet environmental requirements, ST offers these devices in different grades of **ECOPACK** packages, depending on their level of environmental compliance. ECOPACK specifications, grade definitions and product status are available at: www.st.com. ECOPACK is an ST trademark.

4.1 SO-8 package information

Figure 17. SO-8 package outline

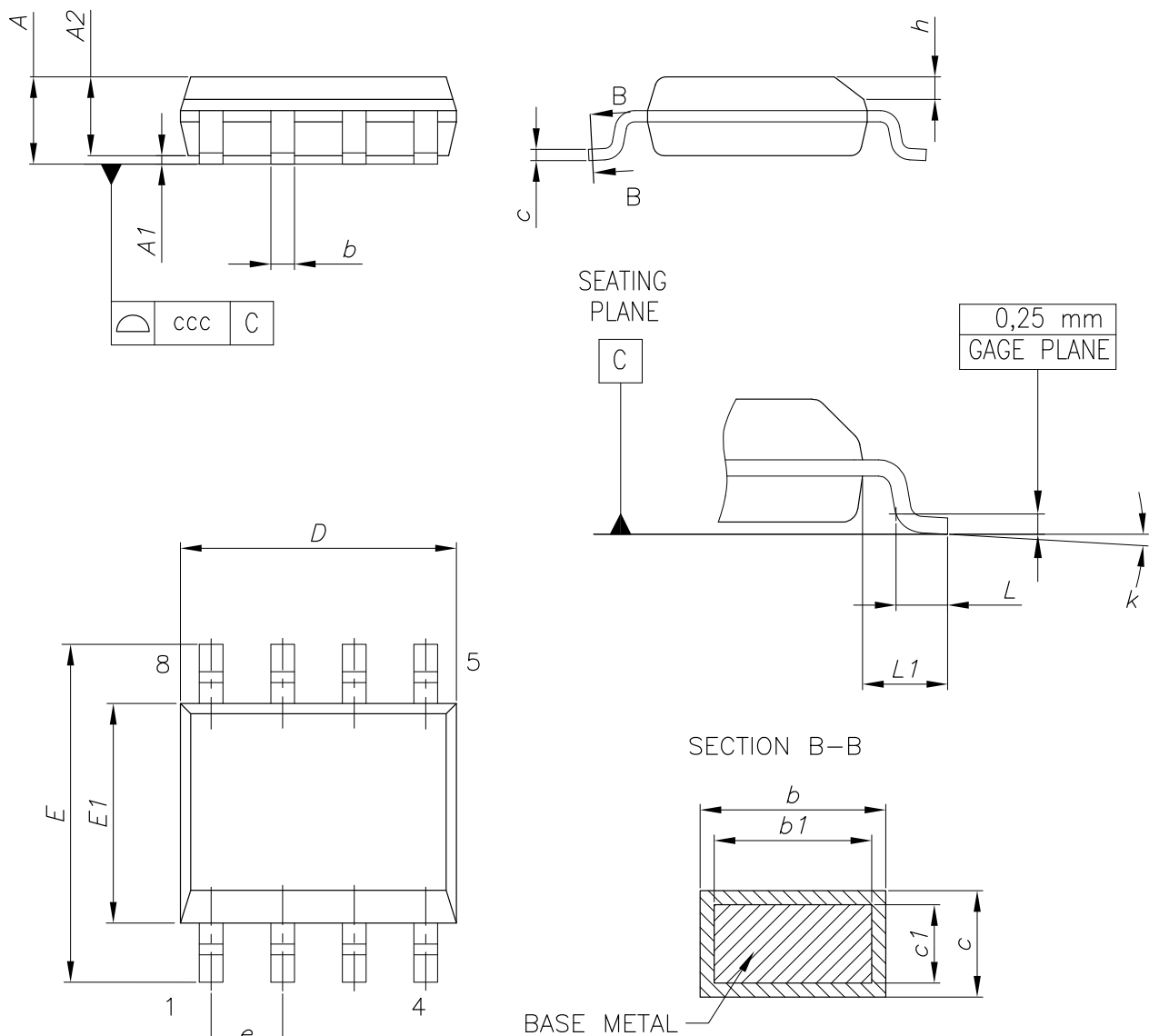

0016023_So-807_fig2_Rev10

Table 7. SO-8 mechanical data

Dim.	mm		
	Min.	Typ.	Max.
A			1.75
A1	0.10		0.25
A2	1.25		
b	0.31		0.51
b1	0.28		0.48
c	0.10		0.25
c1	0.10		0.23
D	4.80	4.90	5.00
E	5.80	6.00	6.20
E1	3.80	3.90	4.00
e		1.27	
h	0.25		0.50
L	0.40		1.27
L1		1.04	
L2		0.25	
k	0°		8°
ccc			0.10

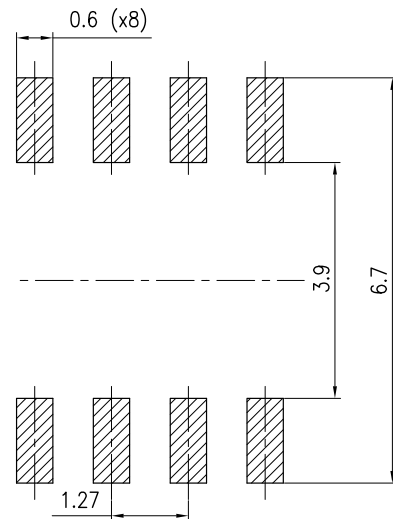
Figure 18. SO-8 recommended footprint (dimensions are in mm)

0016023_So-807_footprint_Rev10

4.2 SO-8 packing information

Figure 19. SO-8 tape and reel dimensions

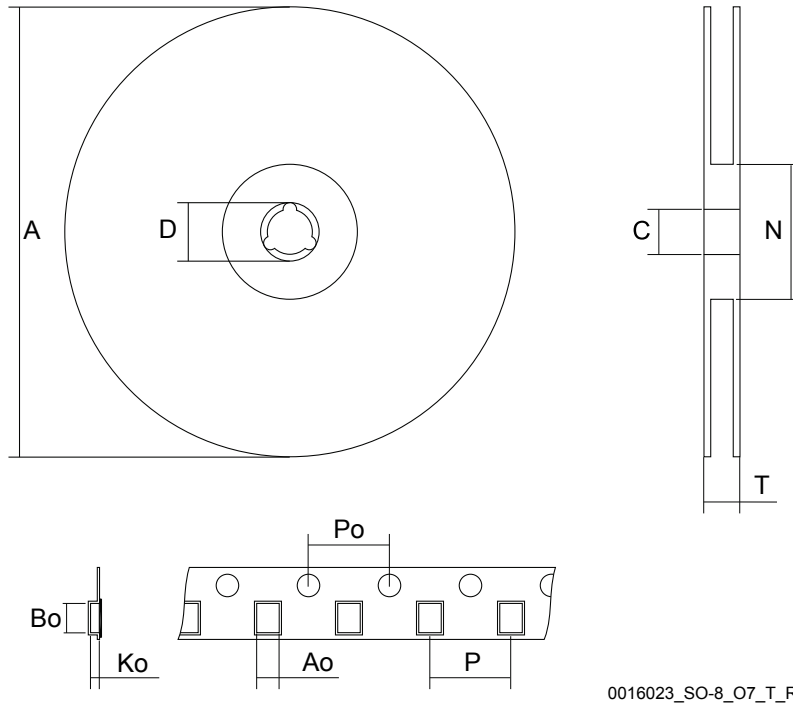

Figure 20. Tape orientation

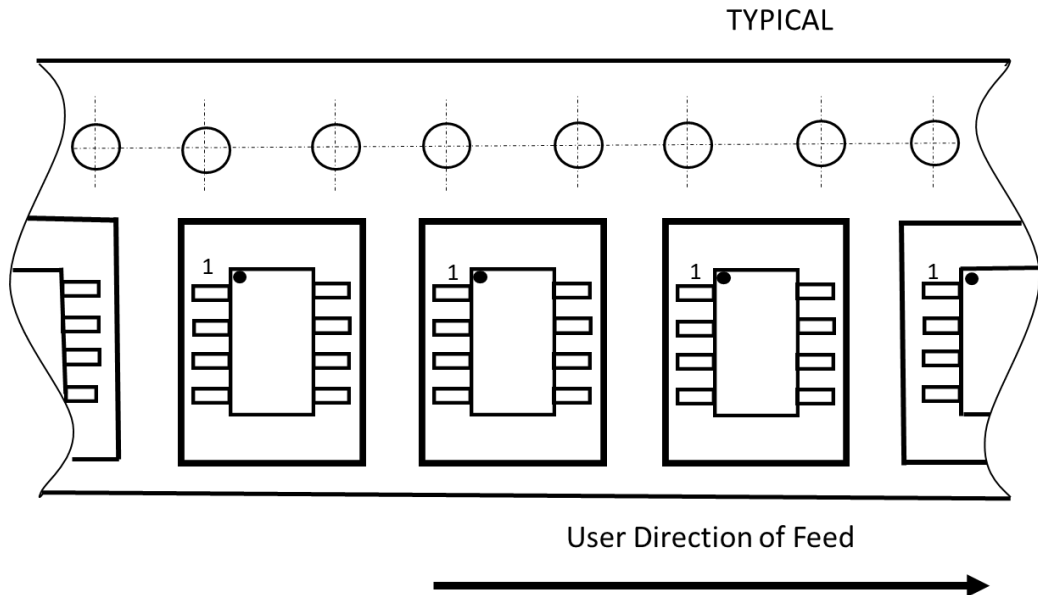

Table 8. SO-8 tape and reel mechanical data

Dim.	mm		
	Min.	Typ.	Max.
A			330
C	12.8		13.2
D	20.2		
N	60		
T			22.4
Ao	6.5	-	6.7
Bo	5.4		5.6
Ko	2.0		2.2
Po	3.9		4.1
P	7.9		8.1

Revision history

Table 9. Document revision history

Date	Version	Changes
03-Mar-2008	1	First release.
18-Mar-2010	2	<i>Figure 2: Safe operating area</i> and <i>Figure 3: Thermal impedance</i> have been changed.
17-Oct-2016	3	Updated title, features and description in cover page. Added AEC-Q101 qualified in the Features section. Updated <i>Package information</i> and <i>Packing information</i> . Minor text changes.
04-Mar-2021	4	Updated Internal schematic for SO-8 dual N-channel and Features in cover page. Updated Table 4. Dynamic . Updated Section 4.2 SO-8 packing information . Minor text changes.

Contents

1	Electrical ratings	2
2	Electrical characteristics	3
2.1	Electrical characteristics (curves)	5
3	Test circuits	7
4	Package information	8
4.1	SO-8 package information	8
4.2	SO-8 packing information	10
	Revision history	12

IMPORTANT NOTICE – PLEASE READ CAREFULLY

STMicroelectronics NV and its subsidiaries (“ST”) reserve the right to make changes, corrections, enhancements, modifications, and improvements to ST products and/or to this document at any time without notice. Purchasers should obtain the latest relevant information on ST products before placing orders. ST products are sold pursuant to ST’s terms and conditions of sale in place at the time of order acknowledgement.

Purchasers are solely responsible for the choice, selection, and use of ST products and ST assumes no liability for application assistance or the design of Purchasers’ products.

No license, express or implied, to any intellectual property right is granted by ST herein.

Resale of ST products with provisions different from the information set forth herein shall void any warranty granted by ST for such product.

ST and the ST logo are trademarks of ST. For additional information about ST trademarks, please refer to www.st.com/trademarks. All other product or service names are the property of their respective owners.

Information in this document supersedes and replaces information previously supplied in any prior versions of this document.

© 2021 STMicroelectronics – All rights reserved