



# PRODUCT/PROCESS CHANGE NOTIFICATION

---

PCN IPD-DIS/13/8275  
Dated 02 Jan 2014

---

**Front-end diffusion Multi sourcing and additional  
Electrical Wafer Sorting capacity for Field Effect Rectifiers Diodes**

**Table 1. Change Implementation Schedule**

Forecasted implementation date for change	26-Dec-2013
Forecasted availability date of samples for customer	26-Dec-2013
Forecasted date for <b>STMicroelectronics</b> change Qualification Plan results availability	26-Dec-2013
Estimated date of changed product first shipment	03-Apr-2014

**Table 2. Change Identification**

Product Identification (Product Family/Commercial Product)	Field Effect Rectifiers Diodes
Type of change	Waferfab additional location
Reason for change	increase the production capacity
Description of the change	- Additional Front-end in subcontractor for the production of the silicons in Singapore - Additional Wafer testing capability in ST Toa Payoh plant
Change Product Identification	Trace code and QA number
Manufacturing Location(s)	



## DOCUMENT APPROVAL

Name	Function
Paris, Eric	Marketing Manager
Duclos, Franck	Product Manager
Cazaubon, Guy	Q.A. Manager

<b>PCN</b>			
<b>Product/Process Change Notification</b>			
<b>Front-end diffusion Multi sourcing and additional Electrical Wafer Sorting capacity for Field Effect Rectifiers Diodes</b>			
<b>Notification number:</b>	IPG-DIS/13/8275	<b>Issue Date</b>	26/12/2013
<b>Issued by</b>	Aline AUGIS		
<b>Product series affected by the change</b>		FERD product family	
<b>Type of change</b>		Wafer fab additional location	
<b>Description of the change</b>			
<ul style="list-style-type: none"> <li>- Additional Front-end in subcontractor for the production of the silicons in Singapore</li> <li>- Additional Wafer testing capability in ST Toa Payoh plant</li> </ul>			
<b>Reason for change</b>			
<ul style="list-style-type: none"> <li>- Increase production capacity</li> <li>- Back-up silicon production , both at dice production and die test levels</li> </ul>			
<b>Former versus changed product:</b>		<p>The changed products do not present modified electrical, dimensional or thermal parameters, leaving unchanged the current information published in the product datasheet</p> <p>The Moisture Sensitivity Level of the part (according to the IPC/JEDEC JSTD-020D standard) remains unchanged.</p> <p>The footprint recommended by ST remains the same.</p> <p>There is no change in the packing modes and the standard delivery quantities either.</p> <p>The products remain in full compliance with the ST ECOPACK@2 grade (“halogen-free”).</p>	
<b>Disposition of former products</b>			
Former products will be continued, as ST is implementing a capacity increase in this change.			

(1) IPG: Industrial & Power Group - ASD: Application Specific Device – IPAD™: Integrated Passive and Active Devices

**Marking and traceability**

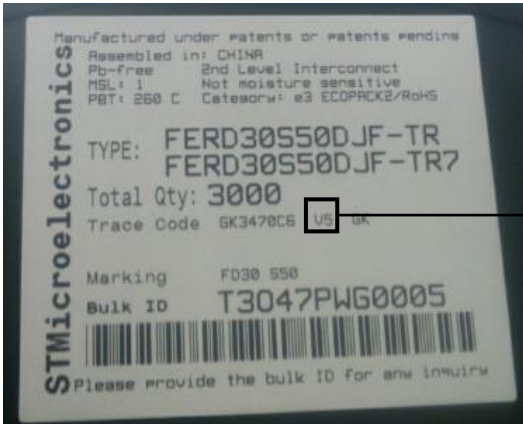
<b>CURRENTLY</b>	<b>AFTER PCN</b>
	<div style="border: 1px solid black; padding: 5px; width: fit-content; margin: 0 auto;"> V5 (ST plant) or F2 (subcontractor) </div>

**Qualification complete date**

W05-2014

**Forecasted sample availability**

Product family	Sub-family	Commercial part Number	Availability date
<b>RECTIFIER</b>	FERD	FERD30S50DJF-TR	Now
	FERD	FERD30M45CT	Now
	FERD	FERD30M45CG-TR	Now

**Change implementation schedule**

Sales types	Estimated production start	Estimated first shipments
<b>FERDxxxx50xx</b>	<b>Wk06-2014</b>	<b>Wk13-2014</b>
<b>FERDxxxx45xx</b>		

**Comments:**

**Customer's feedback**

Please contact your local ST sales representative or quality contact for requests concerning this change notification.  
Absence of acknowledgement of this PCN within 30 days of receipt will constitute acceptance of the change  
Absence of additional response within 90 days of receipt of this PCN will constitute acceptance of the change

**Qualification program and results**

13352QRP Attached

## Reliability Report

*Qualification of additional Front-End and Electrical  
 Wafer Sorting AFER rectifiers dice production*

General Information	
Product Line	RECTIFIERS (BU 78) FERD30M45CT
Product Description	FERD30M45CGTR FERD30S50DJFTR
Product division	ASD&IPAD
Packages	TO-220, D <sup>2</sup> PAK, PQFN 6x5 8L
Die Technology	AFER
Maturity level step	<b>TEMPORARY QUALIFICATION</b>

Locations	
Wafer fab	SUBCONTRACTOR SINGAPORE
Assembly plant	ST SHENZHEN
Reliability Lab	ST TOURS
Reliability assessment	ON GOING

### DOCUMENT INFORMATION

Version	Date	Pages	Prepared by	Comment
1.0	04/12/2013	11	Aude DROMEL	Initial release

Note: This report is a summary of the reliability trials performed in good faith by STMicroelectronics in order to evaluate the potential reliability risks during the product life using a set of defined test methods.

This report does not imply for STMicroelectronics expressly or implicitly any contractual obligations other than as set forth in STMicroelectronics general terms and conditions of Sale. This report and its contents shall not be disclosed to a third party without previous written agreement from STMicroelectronics.



## TABLE OF CONTENTS

<b>1</b>	<b>APPLICABLE AND REFERENCE DOCUMENTS .....</b>	<b>3</b>
<b>2</b>	<b>GLOSSARY .....</b>	<b>3</b>
<b>3</b>	<b>RELIABILITY EVALUATION OVERVIEW.....</b>	<b>4</b>
3.1	OBJECTIVES.....	4
3.2	CONCLUSION.....	4
<b>4</b>	<b>DEVICE CHARACTERISTICS .....</b>	<b>5</b>
4.1	DEVICE DESCRIPTION.....	5
4.2	CONSTRUCTION NOTE .....	5
<b>5</b>	<b>TESTS RESULTS SUMMARY .....</b>	<b>5</b>
5.1	TEST VEHICLE.....	5
5.2	TEST PLAN AND RESULTS SUMMARY .....	6
<b>6</b>	<b>ANNEXES .....</b>	<b>7</b>
6.1	PIN CONNECTION .....	7
6.2	BONDING DIAGRAM.....	8
6.3	PACKAGE OUTLINE/MECHANICAL DATA .....	9
6.4	TESTS DESCRIPTION.....	11





## **1 APPLICABLE AND REFERENCE DOCUMENTS**

Document reference	Short description
JESD47	Stress-Test-Driven Qualification of Integrated Circuits
RER1321008	Reliability Evaluation Report

## **2 GLOSSARY**

SS	Sample Size
PC	Pre-conditioning
HTRB	High Temperature Reverse Bias
TC	Temperature Cycling
AC	Autoclave Test (Pressure Pot)
THB	Temperature Humidity Bias
IOLT	Intermittent Operating Life Test

### **3 RELIABILITY EVALUATION OVERVIEW**

#### **3.1 Objectives**

The objective of this report is to assess a new subcontractor as FE Plant for AFER technology diffusion for 30Amps, 45/50V products mounted in D<sup>2</sup>PAK, TO-220 and PowerFlat 6x5 8leads packages.

Products perimeter and qualification test vehicles are listed below:

Product sub-family	Part Number	Packages
AFER Diodes 30A 45V	FERD30M45CT	TO-220AB
	FERD30M45CG	D <sup>2</sup> PAK
AFER Diodes 30A 50V	FERD30S50DJF	Power Flat

The reliability test methodology used follows the JESD47-H: « Stress Test Driven Qualification Methodology ». The following reliability tests ensuing are:

- TC and IOLT to ensure the mechanical robustness of the products.
- HTRB and HTFB to evaluate the risk of contamination from the resin and the assembly process versus the die layout sensitivity.
- THB, AC to check the robustness to corrosion and the good package hermeticity.

#### **3.2 Conclusion**

Qualification Plan requirements have been fulfilled without exception at this time (no failure). It is stressed that reliability tests have shown that the devices behave correctly against environmental tests. Moreover, the stability of electrical parameters during the accelerated tests demonstrates the ruggedness of the products and safe operation, which is consequently expected during their lifetime. No weakness has been identified by reliability test plan comparing results and drift analysis with initial technology's qualification results.

To prepare final qualification, test plan has to be fulfilled with last results available at this time. A final version of this reliability report will be issued once all tests finished.



## **4 DEVICE CHARACTERISTICS**

### **4.1 Device description**

Field Effect Rectifier

### **4.2 Construction note**

<b>FERDx0x45Cx</b>	
<b>Wafer/Die fab. information</b>	
Wafer fab manufacturing location	Subcontractor Singapore
Technology	AFER
<b>Wafer Testing (EWS) information</b>	
Electrical testing manufacturing location	ST Toa Payoh
<b>Assembly information</b>	
Assembly site	ST CHINA
Package description	TO-220AB / D <sup>2</sup> PAK/ PQFN
Molding compound	ECOPACK
Lead finishing process	Tin (Sn)
<b>Final testing information</b>	
Testing location	ST CHINA

## **5 TESTS RESULTS SUMMARY**

### **5.1 Test vehicle**

<b>Lot #</b>	<b>Part Number</b>	<b>Package</b>	<b>Comments</b>
1	FERD30M45CT	TO-220	
2	FERD30M45CT	TO-220	
3	FERD30M45CGTR	D <sup>2</sup> PAK	
4	FERD30M45CGTR	D <sup>2</sup> PAK	
5	FERD30S50DJFTR	PQFN 6x5 8L	

Detailed results in below chapter will refer to these references.



## 5.2 Test plan and results summary

Missing results for first release are replaced by the expected results availability date

Test	PC	Std ref.	Conditions	SS	Steps	Failure/SS					Note	
						Lot 1	Lot 2	Lot 3	Lot 4	Lot 5		
<b>Die Oriented Tests</b>												
HTRB	-	JESD22 A-108	Tj = Tjmax* VR=36V	187	168H						W51-13	
					500H	0/25**	0/25**	0/30**	0/30**	W01-14		
					1000H	0/25**	0/25**	0/30**	0/30**	W04-14		
* Tjmax=maximal available temperature preventing from thermal runaway. ***for lots with no 168h results, reverse current @high temperature is monitored on all DUTs during the test												
HTFB	-	JESD22 A-108	Tj=150°C	381	168H	0/76	0/77	0/77	0/77		W49-13	
					504H	0/76	0/77	0/77	W49-13	W51-13		
					1000H	0/76	0/77	0/77	W52-13	W02-14		
<b>Package Oriented Tests</b>												
TC	Y	JESD22 A-104	- 65°C/+150° C 2cy/h	177	500 cycles	0/25	0/25	0/25	0/25		W50-13	
IOLT	Y	MIL- STD 750 Metho d 1037	ΔTc = 85°C t <sub>on</sub> = t <sub>off</sub> = 210s	50	5K cycles		0/25		0/25			
					10K cycles		0/25		0/25			
AC	Y	JESD22 A-102	121°C 2 bars 100%RH	100	96H	0/25	0/25	0/25	0/25			
THB	Y	JESD22 A-101	85°C; 85%HR VR=36V	100	168H	0/25	0/25	0/25	0/25			
					504H							
					1000H							

## 6 ANNEXES

### 6.1 Pin connection

Package	Product	Pin connection
TO-220AB	FERD30M45CT	
D <sup>2</sup> PAK	FERD30M45CG	
PowerFLAT	FERD30S50DJF	<p>PowerFLAT 5x6        FERD30S50DJF</p>

## 6.2 Bonding diagram

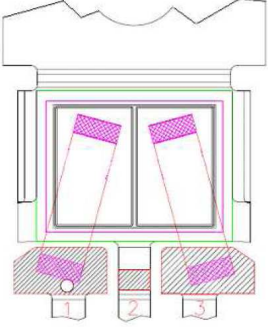
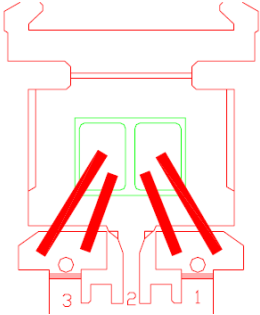
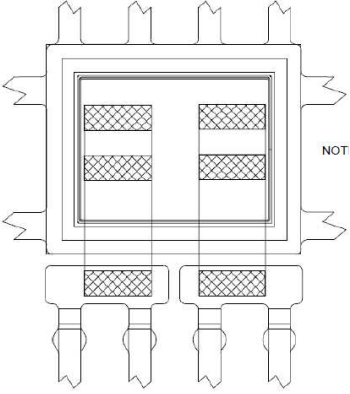
Package	Product	Bonding diagram
TO-220AB	FERD30M45CT	
D <sup>2</sup> PAK	FERD30M45CG	
PowerFLAT	FERD30S50DJF	

Note : Generic scheme (die / wire bonding sizes and die design given as example)

### 6.3 Package outline/Mechanical data

#### TO-220AB dimensions

Ref.	Dimensions			
	Millimeters		Inches	
	Min.	Max.	Min.	Max.
A	4.40	4.60	0.173	0.181
C	1.23	1.32	0.048	0.051
D	2.40	2.72	0.094	0.107
E	0.49	0.70	0.019	0.027
F	0.61	0.88	0.024	0.034
F1	1.14	1.70	0.044	0.066
F2	1.14	1.70	0.044	0.066
G	4.95	5.15	0.194	0.202
G1	2.40	2.70	0.094	0.106
H2	10	10.40	0.393	0.409
L2	16.4 typ.		0.645 typ.	
L4	13	14	0.511	0.551
L5	2.65	2.95	0.104	0.116
L6	15.25	15.75	0.600	0.620
L7	6.20	6.60	0.244	0.259
L9	3.50	3.93	0.137	0.154
M	2.6 typ.		0.102 typ.	
Diam.	3.75	3.85	0.147	0.151

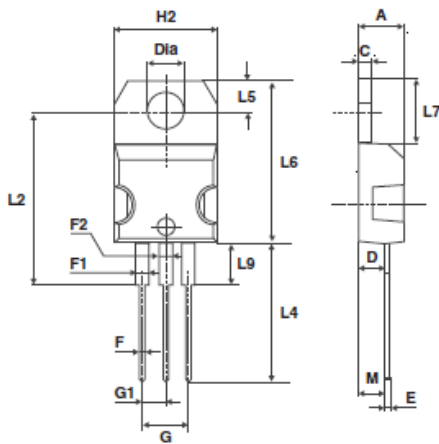

D<sup>2</sup>PAK dimensions

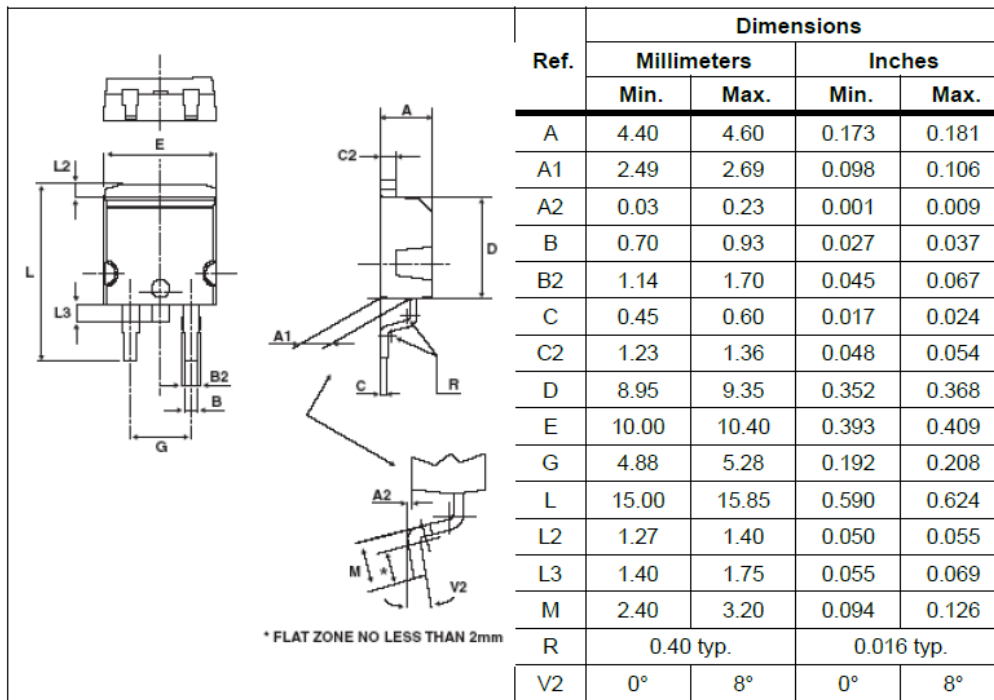

PowerFLAT di\_mensions

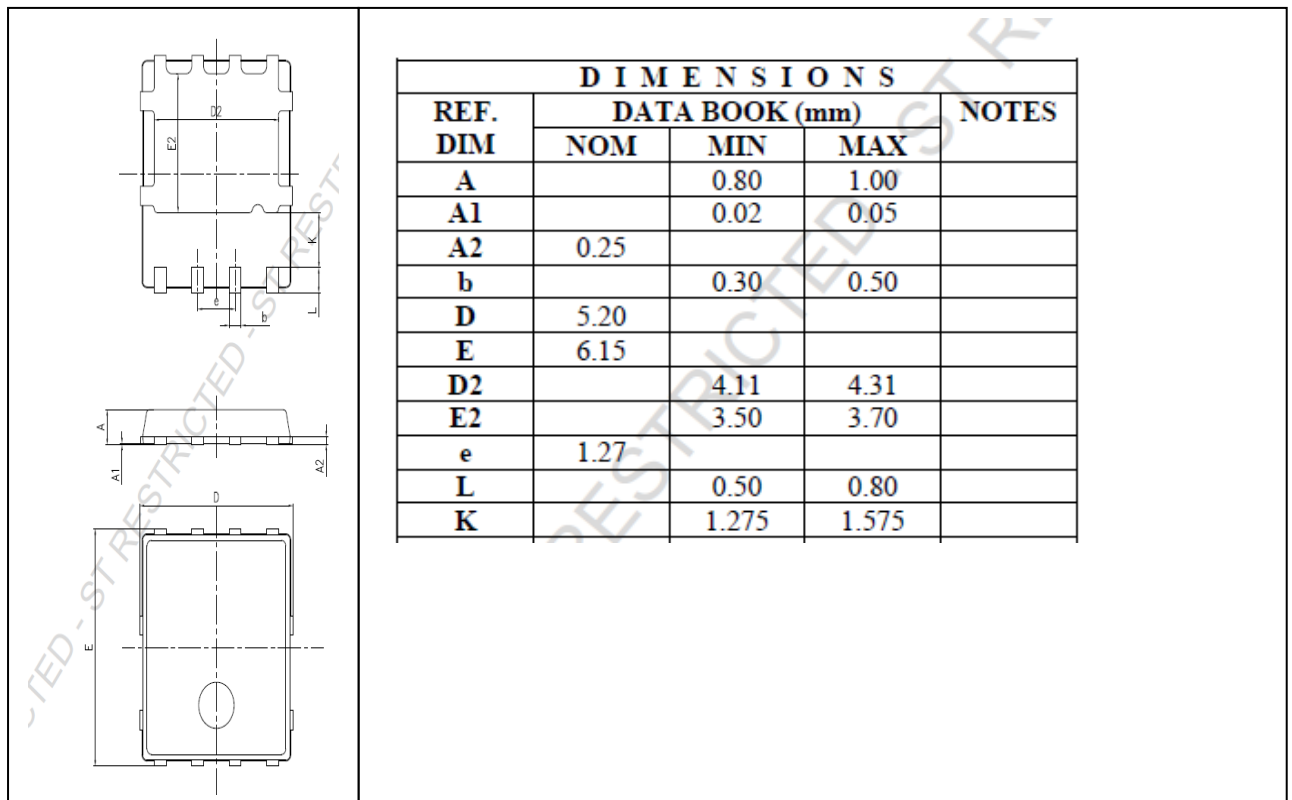



## Tests Description

### 6.4 Tests Description

Test name	Description	Purpose
<b>Die Oriented</b>		
<b>HTRB</b> High Temperature Reverse Bias	The device is stressed in static configuration, trying to satisfy as much as possible the following conditions: low power dissipation; max. supply voltage compatible with diffusion process and internal circuitry limitations;	To determine the effects of bias conditions and temperature on solid state devices over time. It simulates the devices operating condition in an accelerated way. To maximize the electrical field across either reverse-biased junctions or dielectric layers, in order to investigate the failure modes linked to mobile contamination, oxide ageing, layout sensitivity to surface effects.
<b>Package Oriented</b>		
<b>IOLT</b>	All test samples shall be subjected to the specified number of cycles. When stabilized after initial warm-up cycles, a cycle shall consist of an "on" period, when power is applied suddenly, not gradually, to the device for the time necessary to achieve a delta case temperature (delta is the high minus the low mounting surface temperatures) of +85°C (+60°C for thyristors) +15°C, -5°C, followed by an off period, when the power is suddenly removed, for cooling the case through a similar delta temperature. Auxiliary (forced) cooling is permitted during the off period only. Heat sinks are not intended to be used in this test, however, small heat sinks may be used when it is otherwise difficult to control case temperature of test samples, such as with small package types (e.g., TO39).	The purpose of this test is to determine compliance with the specified numbers of cycles for devices subjected to the specified conditions. It accelerates the stresses on all bonds and interfaces between the chip and mounting face of devices subjected to repeated turn on and off of equipment and is therefore most appropriate for case mount style (e.g., stud, flange, and disc) devices.
<b>THB</b> Temperature Humidity Bias	The device is biased in static configuration minimizing its internal power dissipation, and stored at controlled conditions of ambient temperature and relative humidity.	To evaluate the package moisture resistance with electrical field applied, both electrolytic and galvanic corrosion are put in evidence.
<b>TC</b> Temperature Cycling	The device is submitted to cycled temperature excursions, between a hot and a cold chamber in air atmosphere.	To investigate failure modes related to the thermo-mechanical stress induced by the different thermal expansion of the materials interacting in the die-package system. Typical failure modes are linked to metal displacement, dielectric cracking, molding compound delamination, wire-bonds failure, die-attach layer degradation.
<b>AC</b> Autoclave	The device is stored in saturated steam, at fixed and controlled conditions of pressure and temperature.	To investigate corrosion phenomena affecting die or package materials, related to chemical contamination and package hermeticity.

**Please Read Carefully:**

Information in this document is provided solely in connection with ST products. STMicroelectronics NV and its subsidiaries ("ST") reserve the right to make changes, corrections, modifications or improvements, to this document, and the products and services described herein at any time, without notice.

All ST products are sold pursuant to ST's terms and conditions of sale.

Purchasers are solely responsible for the choice, selection and use of the ST products and services described herein, and ST assumes no liability whatsoever relating to the choice, selection or use of the ST products and services described herein.

No license, express or implied, by estoppel or otherwise, to any intellectual property rights is granted under this document. If any part of this document refers to any third party products or services it shall not be deemed a license grant by ST for the use of such third party products or services, or any intellectual property contained therein or considered as a warranty covering the use in any manner whatsoever of such third party products or services or any intellectual property contained therein.

**UNLESS OTHERWISE SET FORTH IN ST'S TERMS AND CONDITIONS OF SALE ST DISCLAIMS ANY EXPRESS OR IMPLIED WARRANTY WITH RESPECT TO THE USE AND/OR SALE OF ST PRODUCTS INCLUDING WITHOUT LIMITATION IMPLIED WARRANTIES OF MERCHANTABILITY, FITNESS FOR A PARTICULAR PURPOSE ( AND THEIR EQUIVALENTS UNDER THE LAWS OF ANY JURISDICTION ), OR INFRINGEMENT OF ANY PATENT, COPYRIGHT OR OTHER INTELLECTUAL PROPERTY RIGHT.**

**ST PRODUCTS ARE NOT DESIGNED OR AUTHORIZED FOR USE IN: (A) SAFETY CRITICAL APPLICATIONS SUCH AS LIFE SUPPORTING, ACTIVE IMPLANTED DEVICES OR SYSTEMS WITH PRODUCT FUNCTIONAL SAFETY REQUIREMENTS; (B) AERONAUTIC APPLICATIONS; (C) AUTOMOTIVE APPLICATIONS OR ENVIRONMENTS, AND/OR (D) AEROSPACE APPLICATIONS OR ENVIRONMENTS. WHERE ST PRODUCTS ARE NOT DESIGNED FOR SUCH USE, THE PURCHASER SHALL USE PRODUCTS AT PURCHASER'S SOLE RISK, EVEN IF ST HAS BEEN INFORMED IN WRITING OF SUCH USAGE, UNLESS A PRODUCT IS EXPRESSLY DESIGNATED BY ST AS BEING INTENDED FOR "AUTOMOTIVE, AUTOMOTIVE SAFETY OR MEDICAL" INDUSTRY DOMAINS ACCORDING TO ST PRODUCT DESIGN SPECIFICATIONS. PRODUCTS FORMALLY ESCC, QML OR JAN QUALIFIED ARE DEEMED SUITABLE FOR USE IN AEROSPACE BY THE CORRESPONDING GOVERNMENTAL AGENCY.**

**RESTRICTIONS OF USE AND CONFIDENTIALITY OBLIGATIONS:**

**THIS DOCUMENT AND ITS ANNEXES CONTAIN ST PROPRIETARY AND CONFIDENTIAL INFORMATION. THE DISCLOSURE, DISTRIBUTION, PUBLICATION OF WHATSOEVER NATURE OR USE FOR ANY OTHER PURPOSE THAN PROVIDED IN THIS DOCUMENT OF ANY INFORMATION CONTAINED IN THIS DOCUMENT AND ITS ANNEXES IS SUBMITTED TO ST PRIOR EXPRESS AUTHORIZATION. ANY UNAUTHORIZED REVIEW, USE, DISCLOSURE OR DISTRIBUTION OF SUCH INFORMATION IS EXPRESSLY PROHIBITED.**

Resale of ST products with provisions different from the statements and/or technical features set forth in this document shall immediately void any warranty granted by ST for the ST product or service described herein and shall not create or extend in any manner whatsoever, any liability of ST.

ST and the ST logo are trademarks or registered trademarks of ST in various countries.

Information in this document supersedes and replaces all information previously supplied.

The ST logo is a registered trademark of STMicroelectronics. All other names are the property of their respective owners

©2013 STMicroelectronics - All rights reserved.

STMicroelectronics group of companies

Australia - Belgium - Brazil - Canada - China - Czech Republic - Finland - France - Germany - Hong Kong - India - Israel - Italy - Japan - Malaysia - Malta - Morocco - Philippines - Singapore - Spain - Sweden - Switzerland - United Kingdom - United States of America

[www.st.com](http://www.st.com)

