

## CDBMT240-HF Thru. CDBMT2100-HF

Reverse Voltage: 40 to 100 Volts

Forward Current: 2.0 Amp

RoHS Device

Halogen Free

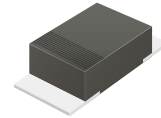

### Features

- Batch process design, excellent power dissipation offers better reverse leakage current and thermal resistance.
- Low profile surface mounted application in order to optimize board space.
- Tiny plastic SMD package.
- Low power loss, high efficiency.
- High current capability, low forward voltage drop.
- High surge capability.
- Guardring for overvoltage protection.
- Ultra high-speed switching.
- Silicon epitaxial planar chip, metal silicon junction.
- Lead-free parts meet environmental standards of MIL-STD-19500 /228

### Mechanical data

- Epoxy: UL94V0 rated flame retardant.
- Case: Molded plastic, SOD-123H/MINI SMA
- Terminals: Solderable per MIL-STD-750, Method 2026.
- Polarity: Indicated by cathode band.
- Mounting Position: Any
- Weight: 0.011 grams approx.

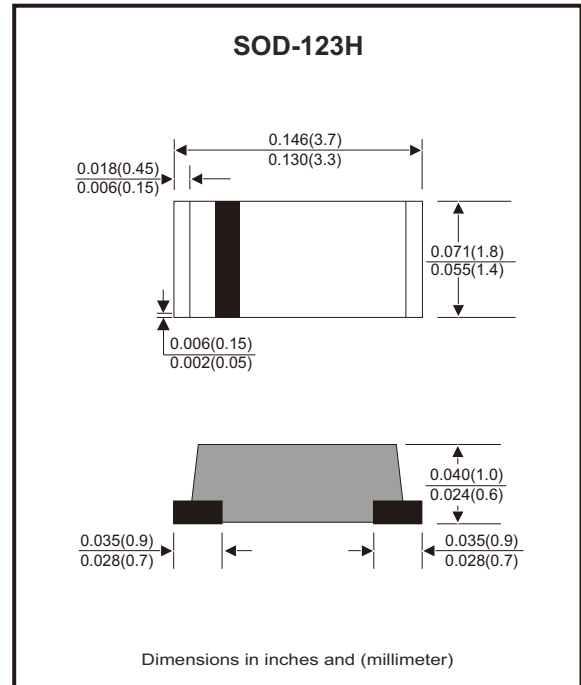

### Circuit Diagram



### Maximum Ratings and Electrical Characteristics (at T<sub>A</sub>=25°C unless otherwise noted)

Parameter	Symbol	CDBMT240-HF	CDBMT260-HF	CDBMT2100-HF	Units
Repetitive peak reverse voltage	V <sub>RRM</sub>	40	60	100	V
RMS voltage	V <sub>RMS</sub>	28	42	70	V
Continuous reverse voltage	V <sub>R</sub>	40	60	100	V
Max. forward voltage @ I <sub>F</sub> = 2.0A	V <sub>F</sub>	0.50	0.70	0.85	V
Operating temperature range	T <sub>J</sub>	-55 to +125	-55 to +150		°C

Parameter	Conditions	Symbol	MIN.	TYP.	MAX.	Units
Forward rectified current	see Fig.1	I <sub>O</sub>			2.0	A
Forward surge current	8.3ms single half sine-wave superimposed on rate load (JEDEC method)	I <sub>FSM</sub>			50	A
Reverse current	V <sub>R</sub> = V <sub>RRM</sub> T <sub>J</sub> = 25°C	I <sub>R</sub>			0.5	mA
	V <sub>R</sub> = V <sub>RRM</sub> T <sub>J</sub> = 100°C	I <sub>R</sub>			10	mA
Thermal resistance	Junction to ambient	R <sub>θJA</sub>		85		°C/W
Diode junction capacitance	f=1MHz and applied 4V DC reverse Voltage	C <sub>J</sub>		160		pF
Storage temperature		T <sub>STG</sub>	-65		+175	°C

Note 1: f=1MHz and applied 4V DC reverse voltage.

Company reserves the right to improve product design, functions and reliability without notice. REV:D

## Rating and Characteristic Curves (CDBMT240-HF Thru. CDBMT2100-HF)

Fig.1 - Typical Forward Current Derating Curve

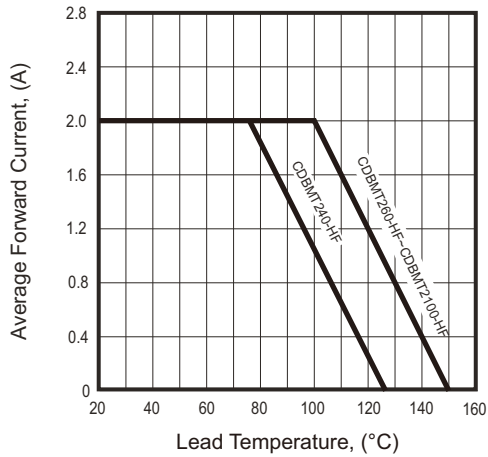

Fig.2 - Typical Forward Characteristics

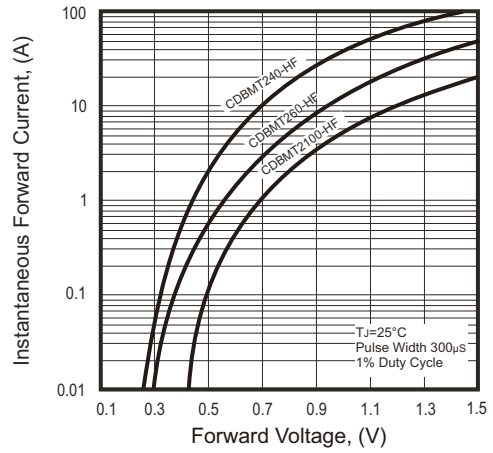

Fig.3 - Maximum Non-repetitive Forward Surge Current

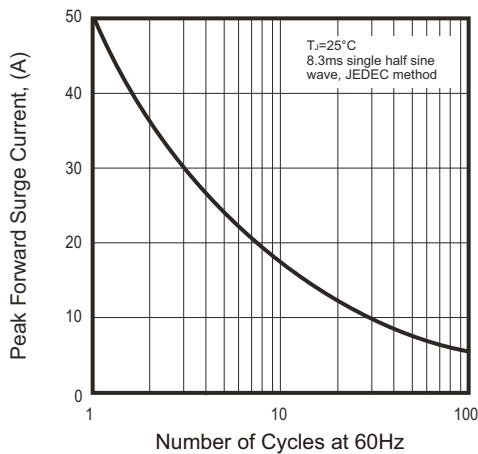

Fig.4 - Typical Junction Capacitance

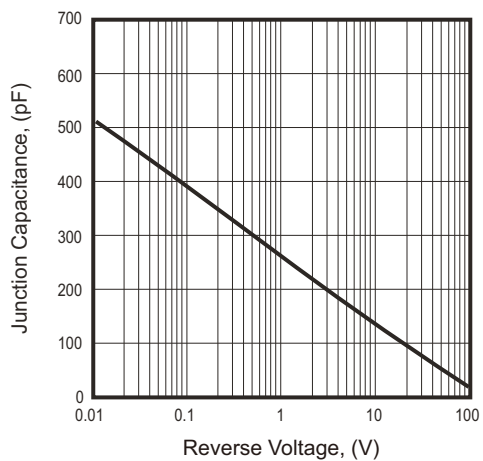
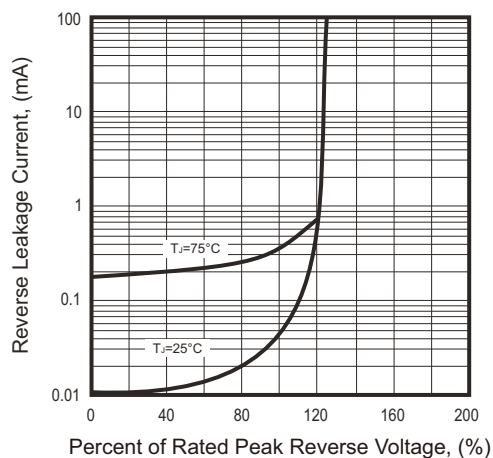
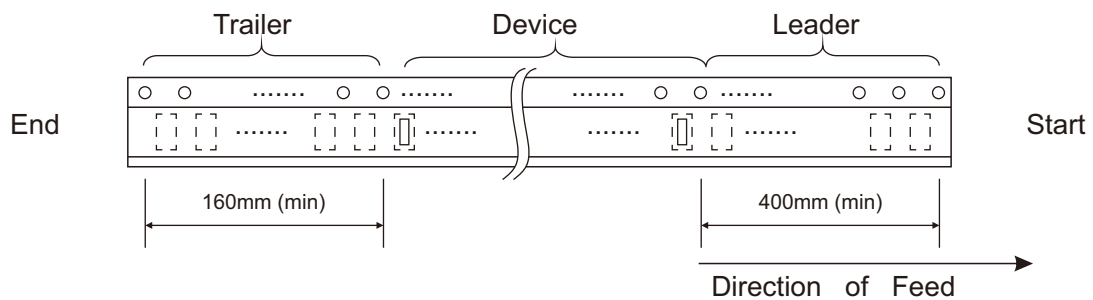
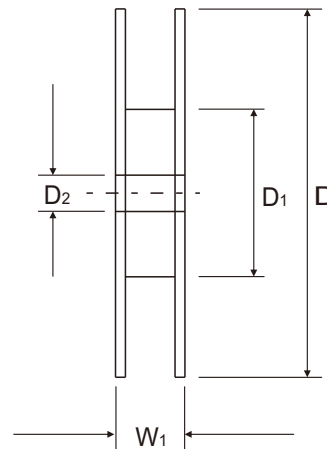
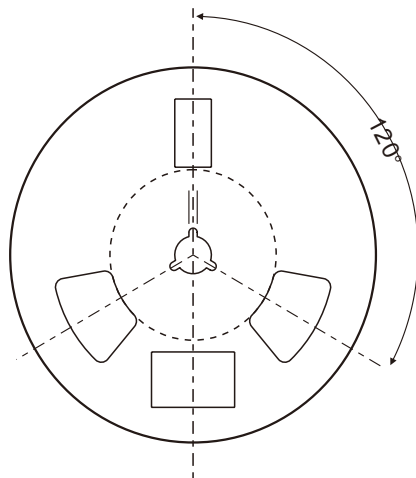
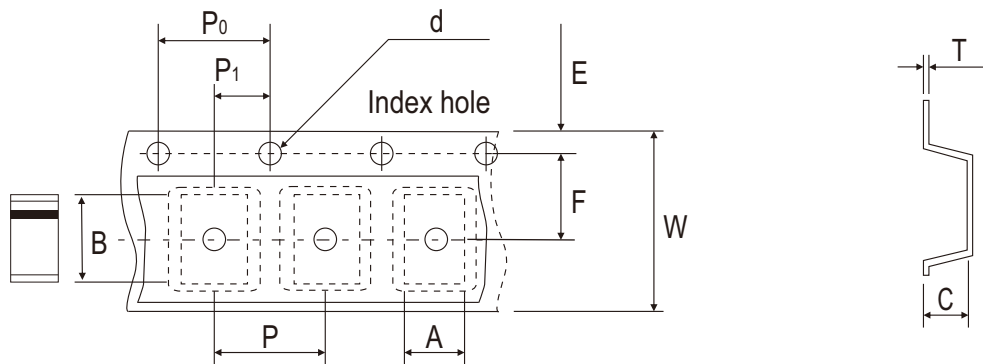

Fig.5 - Typical Reverse Characteristics



## Reel Taping Specification



SOD-123H	SYMBOL	A	B	C	d	D	D1	D2
	(mm)	2.00 ± 0.10	3.85 ± 0.10	1.10 ± 0.10	1.50 ± 0.10	178.00 ± 2.00	62.00 (min)	13.00 ± 0.50
	(inch)	0.079 ± 0.004	0.152 ± 0.004	0.043 ± 0.004	0.059 ± 0.004	7.007 ± 0.079	2.441 (min)	0.512 ± 0.020

SOD-123H	SYMBOL	E	F	P	P0	P1	T	W	W1
	(mm)	1.75 ± 0.10	3.50 ± 0.10	4.00 ± 0.10	4.00 ± 0.10	2.00 ± 0.10	0.23 ± 0.10	8.00 ± 0.30	11.40 ± 1.00
	(inch)	0.069 ± 0.004	0.138 ± 0.004	0.157 ± 0.004	0.157 ± 0.004	0.079 ± 0.004	0.009 ± 0.004	0.315 ± 0.012	0.449 ± 0.039

Company reserves the right to improve product design, functions and reliability without notice. REV:D

## Marking Code

Part Number	Marking Code
CDBMT240-HF	24
CDBMT260-HF	26
CDBMT2100-HF	20



xx = Product type marking code

## Suggested P.C.B. PAD Layout

SIZE	SOD-123H	
	(mm)	(inch)
A	3.00	0.118
B	1.30	0.051
C	1.80	0.071
D	4.30	0.169
E	1.70	0.067

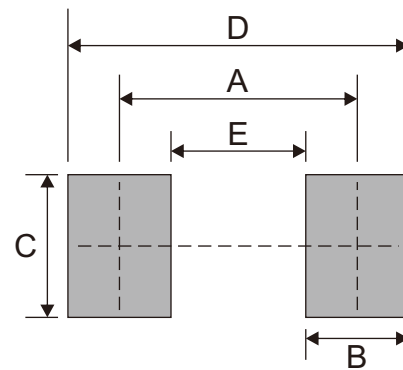

Note: 1. The pad layout is for reference purpose only.

## Standard Packaging

Case Type	REEL PACK	
	REEL ( pcs )	Reel Size (inch)
SOD-123H	3,000	7