

---

**High-Current/Overvoltage Protection Switch IC with Voltage Suppressor**

---

No. EA-328-170517

**OUTLINE**

The R5560Z is a CMOS-based high-current and overvoltage protection switch IC with voltage suppressor that uses an NMOS pass transistor to achieve ultra-low on resistance (Typ. 38 mΩ). The R5560Z consists of a soft-start circuit, a startup debounce circuit, an overvoltage lockout (OVLO) circuit, and a thermal shutdown circuit.

The OVLO threshold is adjustable with optional external resistors to any voltage between 4 V and 20 V. The internal OVLO threshold (preset to 6.8 V ±3%) is available when connecting the OVLO pin to GND.

An internal clamp can protect low-voltage systems from surges up to +80 V (The surge waveform is compliant with IEC 61000-4-5 Combination Wave.) without using a transient-voltage-suppression (TVS) diode.

The R5560Z is offered in a small and thin WLCSP-12-P2 (1.288 mm x 1.828 mm) package which achieves the smallest possible footprint solution on boards where area is limited.

**FEATURES**

- Input Voltage Range (Maximum Rating) ..... 2.5 V to 28 V (29 V)
- Surge Immunity ..... 80 V
- Switch On Resistance ..... Typ.38 mΩ
- Input Supply Current ..... Typ. 19 μA
- Internal Fixed Preset OVLO Threshold ..... 6.8 V±3%
- Adjustable OVLO Threshold with OVLO Pin
- Adjustable OVLO Threshold Range ..... 4 V to 20 V
- Power Good (PG) Function
- Soft-start Function
- Internal Startup Debounce ..... Typ.15 ms
- Thermal Shutdown Protection ..... Typ.150°C
- Package ..... WLCSP-12-P2

**APPLICATIONS**

- Smartphones
- Tablet PCs
- Mobile Internet Devices

---

**R5560Z**

---

No. EA-328-170517

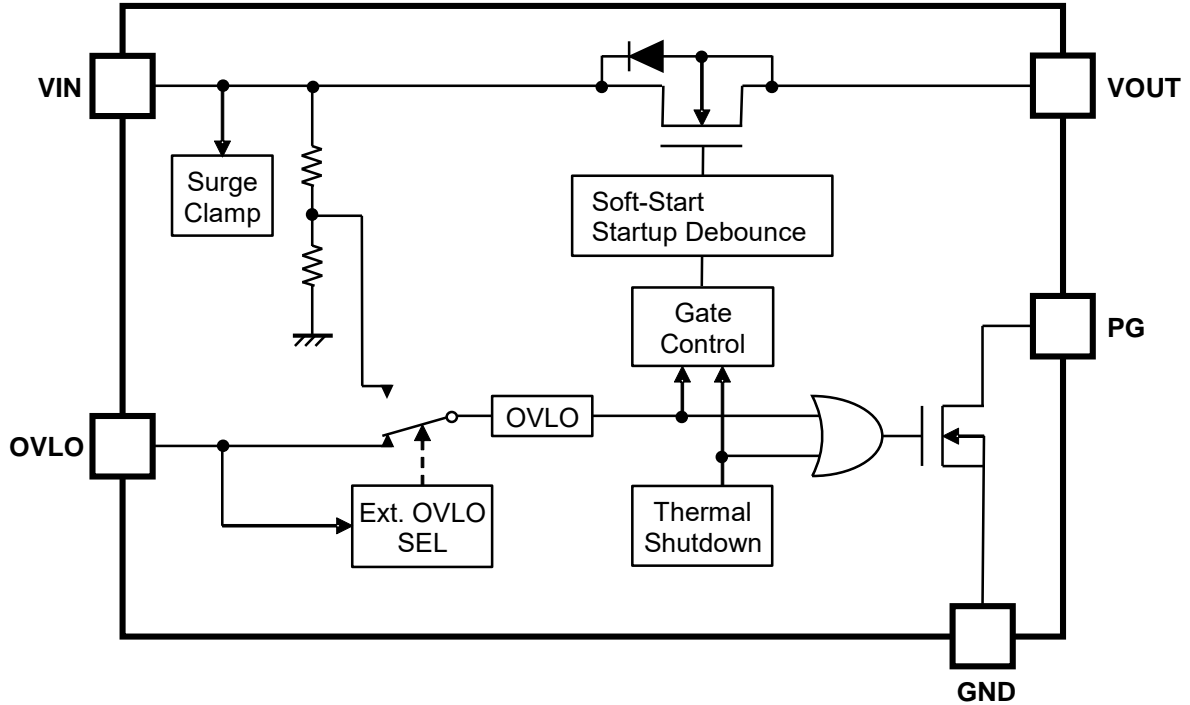
**BLOCK DIAGRAM**

R5560Z Block Diagram

**SELECTION GUIDE****Selection Guide**

Product Name	Package	Quantity per Reel	Pb Free	Halogen Free
R5560Zxx1A-TL-F	WLCSP-12-P2	5,000 pcs	Yes	Yes

xx: Designate the internal OVLO threshold.

01: 6.8 V

## PIN DESCRIPTION

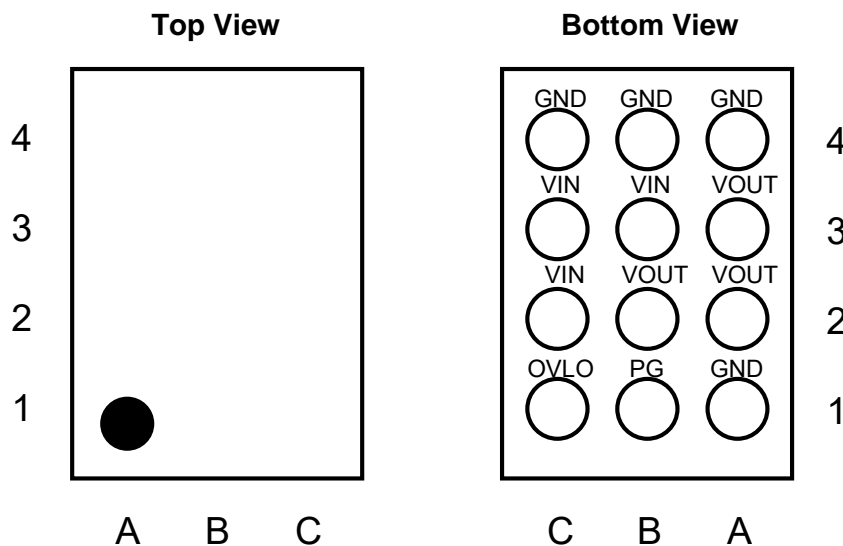

**WLCSP-12-P2 Pin Configuration**

### WLCSP-12-P2 Pin Description

Pin No	Symbol	Pin Description
A1, A4, B4, C4	GND <sup>(1)</sup>	Ground pins.
A2, A3, B2	VOUT <sup>(2)</sup>	Output pins.
B1	PG	Power Good output pin. (Nch open drain) PG is driven low after input voltage is stable between minimum $V_{IN}$ and $V_{IN\_OVLO}$ after startup debounce except during thermal shutdown operation.
B3, C2, C3	VIN <sup>(3)</sup>	Input pins.
C1	OVLO	External OVLO adjustment pin. Connect OVLO to GND when using the internal threshold. Connect a resistor-divider to OVLO to set a different OVLO threshold.

<sup>(1)</sup> Connect the pins that have the same symbols together: A1, A4, B4 and C4

<sup>(2)</sup> Connect the pins that have the same symbols together: A2, A3 and B2

<sup>(3)</sup> Connect the pins that have the same symbols together: B3, C2 and C3

---

**R5560Z**

---

No. EA-328-170517

**ABSOLUTE MAXIMUM RATINGS****Absolute Maximum Ratings**

Symbol	Item	Rating	Unit
V <sub>IN</sub>	Input Voltage	-0.3 to 29	V
V <sub>OUT</sub>	Output Voltage	-0.3 to V <sub>IN</sub> + 0.3	V
V <sub>OVLO</sub>	OVLO Pin Input Voltage	-0.3 to 24	V
V <sub>PG</sub>	PG Pin Voltage	-0.3 to 6.5	V
I <sub>PG</sub>	PG Pin Current	14	mA
I <sub>OUT</sub>	Continuous Output Current	4.5	A
P <sub>D</sub>	Power Dissipation <sup>(1)</sup>	1000	mW
T <sub>a</sub>	Operating Temperature Range	-40 to 85	°C
T <sub>stg</sub>	Storage Temperature	-55 to 125	°C

**ABSOLUTE MAXIMUM RATINGS**

Electronic and mechanical stress momentarily exceeded absolute maximum ratings may cause the permanent damages and may degrade the life time and safety for both device and system using the device in the field. The functional operation at or over these absolute maximum ratings are not assured.

---

<sup>(1)</sup> Refer to *PACKAGE INFORMATION* for detailed information.

---

## ELECTRICAL CHARACTERISTICS

$V_{IN} = 2.5\text{ V to }28\text{ V}$ ,  $I_{OUT} = 1\text{ mA}$ ,  $C_{IN} = 0.1\text{ }\mu\text{F}$ , unless otherwise noted. Typical values are  $V_{IN} = 5\text{ V}$ ,  $T_a = 25^\circ\text{C}$ .

The specifications surrounded by   are guaranteed by design engineering at  $-40^\circ\text{C}$  to  $85^\circ\text{C}$ .

### R5560Z Electrical Characteristics

( $T_a = 25^\circ\text{C}$ )

Symbol	Item	Conditions	Min.	Typ.	Max.	Unit	
$V_{IN}$	Input Voltage		<span style="border: 1px solid black; padding: 0 2px;">2.5</span>		<span style="border: 1px solid black; padding: 0 2px;">28</span>	V	
$V_{IN\_CLAMP}$	Input Clamp Voltage	$I_{IN} = 10\text{ mA}$		33		V	
$I_{IN}$	Input Supply Current	$V_{IN} = 5\text{ V}$ , $I_{OUT} = 0\text{ mA}$		19	<span style="border: 1px solid black; padding: 0 2px;">50</span>	$\mu\text{A}$	
$I_{IN\_OVLO}$	OVLO Supply Current	$V_{IN} = 5\text{ V}$ , $V_{OUT} = 0\text{ V}$ , $V_{OVLO} = 3\text{ V}$		16	<span style="border: 1px solid black; padding: 0 2px;">50</span>	$\mu\text{A}$	
$R_{ON}$	On Resistance	$V_{IN} = 5\text{ V}$ , $I_{OUT} = 1\text{ A}$ , $T_a = 25^\circ\text{C}$		38	53	$\text{m}\Omega$	
$V_{IN\_OVLO}$	Internal Fixed Preset OVLO Threshold	$V_{OVLO} = 0\text{ V}$	$V_{IN}$ rising	<span style="border: 1px solid black; padding: 0 2px;">6.6</span>	6.8	<span style="border: 1px solid black; padding: 0 2px;">7.0</span>	V
			$V_{IN}$ falling	<span style="border: 1px solid black; padding: 0 2px;">6.5</span>			V
$V_{OVLO\_SEL}$	External OVLO Select Threshold		<span style="border: 1px solid black; padding: 0 2px;">0.2</span>	0.25	<span style="border: 1px solid black; padding: 0 2px;">0.3</span>	V	
$V_{OVLO\_TH}$	OVLO set Threshold		<span style="border: 1px solid black; padding: 0 2px;">1.18</span>	1.22	<span style="border: 1px solid black; padding: 0 2px;">1.26</span>	V	
$V_{IN\_OVLO}$	Adjustable OVLO Threshold Range <sup>(1)</sup>		<span style="border: 1px solid black; padding: 0 2px;">4</span>		<span style="border: 1px solid black; padding: 0 2px;">20</span>	V	
$I_{OVLO}$	OVLO Input Leakage		<span style="border: 1px solid black; padding: 0 2px;">-100</span>		<span style="border: 1px solid black; padding: 0 2px;">100</span>	nA	
$V_{OL}$	PG Output Low Voltage	$I_{SINK} = 1\text{ mA}$			<span style="border: 1px solid black; padding: 0 2px;">0.4</span>	V	
$V_{PG\_LEAK}$	PG Leakage Current	$V_{IO} = 3.3\text{ V}$	<span style="border: 1px solid black; padding: 0 2px;">-1</span>		<span style="border: 1px solid black; padding: 0 2px;">1</span>	$\mu\text{A}$	
$t_{DEB}$	IN Debounce Time	$2.5\text{ V} < V_{IN} < V_{IN\_OVLO}$ to $V_{OUT} = 10\%$ of $V_{IN}$		15		ms	
$t_{ON}$	Turn-On Time during Soft-Start	$V_{IN} = 5\text{ V}$ , $R_{LOAD} = 100\ \Omega$ , $C_{OUT} = 100\ \mu\text{F}$ , $V_{OUT} = 10\%$ of $V_{IN}$ to $90\%$ of $V_{IN}$		2		ms	
$t_{OFF}$	Turn-Off Time	$V_{IN} > V_{OVLO}$ , $2\text{ V}/\mu\text{s}$ to $V_{OUT} = 80\%$ of $V_{IN}$ , $R_{LOAD} = 100\ \Omega$		2		$\mu\text{s}$	
$C_{OUT}$	OUT Load Capacitance				<span style="border: 1px solid black; padding: 0 2px;">1000</span>	$\mu\text{F}$	
$T_{SHDN}$	Thermal Shutdown			150		$^\circ\text{C}$	
$T_{HYST}$	Thermal Shutdown Hysteresis			20		$^\circ\text{C}$	

All test items listed under ELECTRICAL CHARACTERISTICS are done under the pulse load condition ( $T_j \approx T_a = 25^\circ\text{C}$ ) except Adjustable OVLO Threshold Range, Turn-On Time during Soft-Start, Turn-Off Time and OUT Load Capacitance.

### RECOMMENDED OPERATING CONDITIONS (ELECTRICAL CHARACTERISTICS)

All of electronic equipment should be designed that the mounted semiconductor devices operate within the recommended operating conditions. The semiconductor devices cannot operate normally over the recommended operating conditions, even if when they are used over such conditions by momentary electronic noise or surge. And the semiconductor devices may receive serious damage when they continue to operate over the recommended operating conditions.

<sup>(1)</sup> Refer to *TECHNICAL NOTES* for details.

## APPLICATION INFORMATION

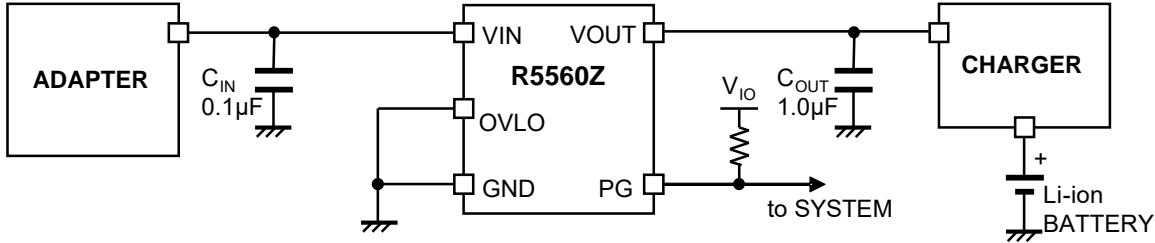

Internal Fixed Preset OVLO Typical Application

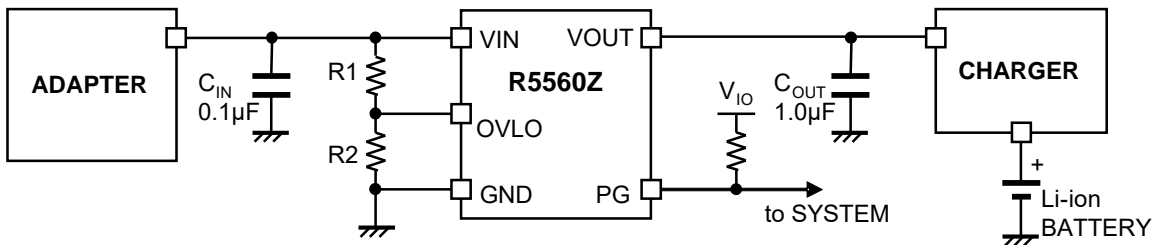

External Adjustable OVLO Typical Application

## TECHNICAL NOTES

The performance of a power source circuit using this device is highly dependent on a peripheral circuit. A peripheral component or the device mounted on PCB should not exceed a rated voltage, a rated current or a rated power. When designing a peripheral circuit, please be fully aware of the following points.

- Set the OVLO pin input voltage to or below the external OVLO select threshold (Typ. 0.25 V) when using the internal fixed preset OVLO threshold (preset to 6.8 V ±3%). Connecting the OVLO pin to the GND pin without using R1 and R2 is recommended. Don't leave the OVLO pin the floating state.
- External resistors R1 and R2 are required in order to adjust the OVLO threshold. The formula to calculate the OVLO threshold is as follow. Adjustable OVLO threshold range is between 4 V and 20 V.

$$V_{IN\_OVLO} = V_{OVLO\_TH} \times \left(1 + \frac{R1}{R2}\right)$$

The appropriate value for reducing current consumption is R1 = 1 MΩ.

- If the voltage at the V<sub>OUT</sub> is larger than the V<sub>IN</sub>, large currents may flow and can cause permanent damage to the device. The R5560Z is designed to control a current flow from V<sub>IN</sub> to V<sub>OUT</sub>.

□

**TIMING CHART**

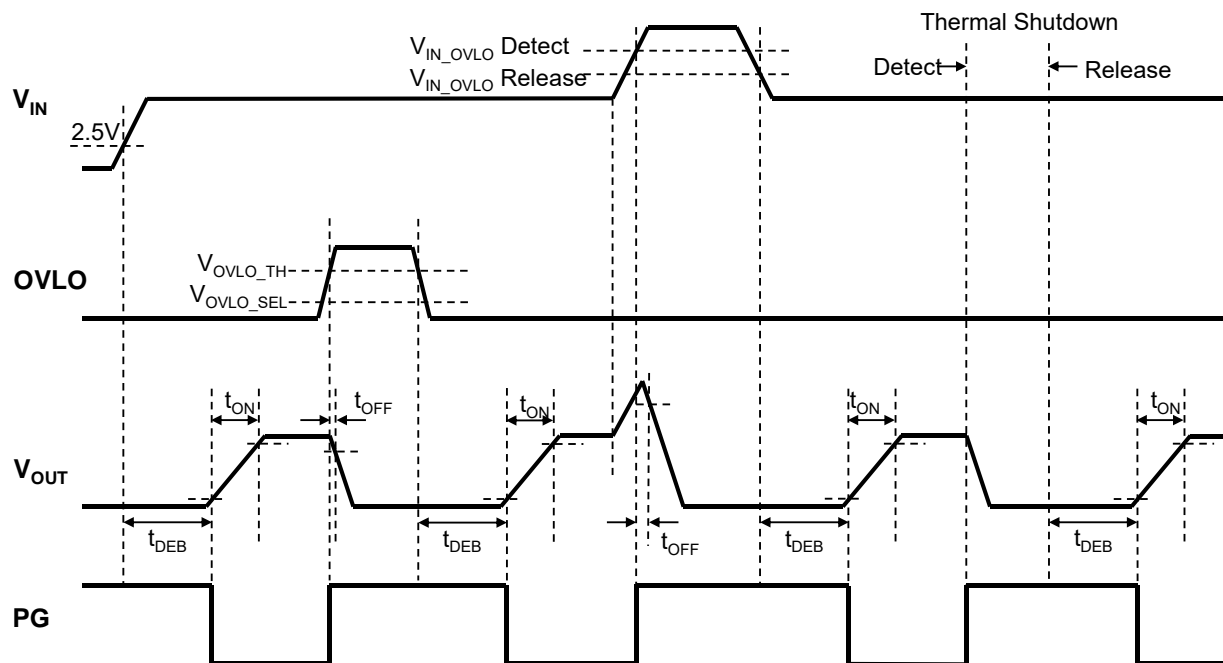

**Internal Fixed Preset OVLO Timing Chart**

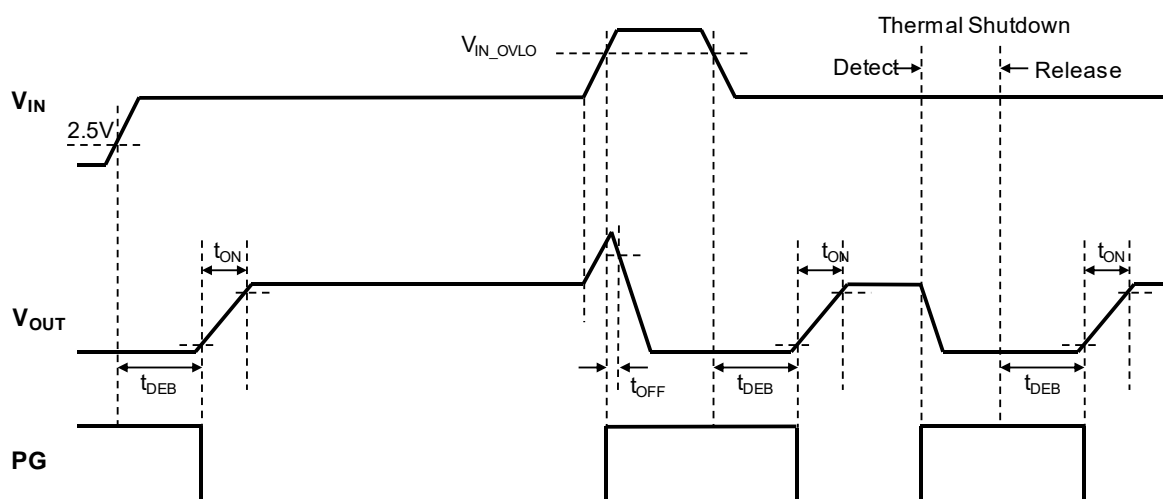

**External Adjustable OVLO Timing Chart**

## TYPICAL CHARACTERISTICS

Note: Typical Characteristics are intended to be used as reference data; they are not guaranteed.

### 1) Input Supply Current vs. Input Voltage

( $V_{IN\_OVLO} = 6.8\text{ V}$ )

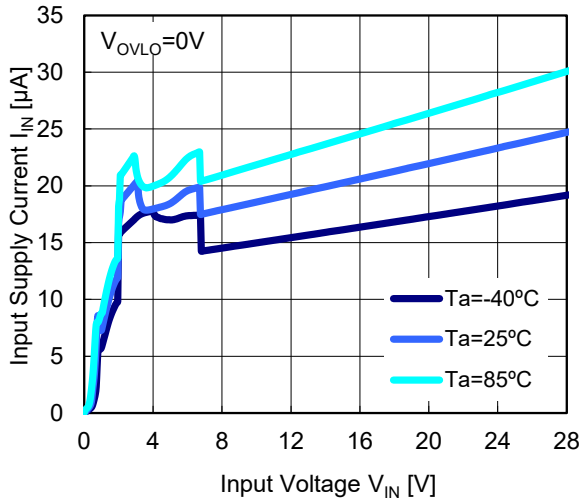

### 2) Input Supply Current vs. Input Voltage

( $V_{IN\_OVLO} = 20\text{ V}$ )

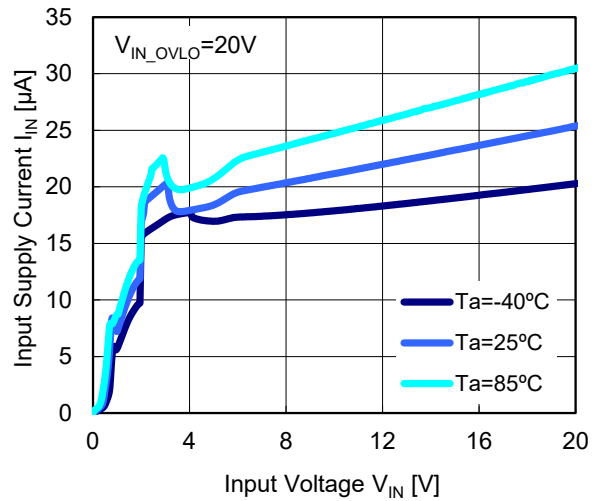

### 3) OVLO Supply Current vs. Input Voltage

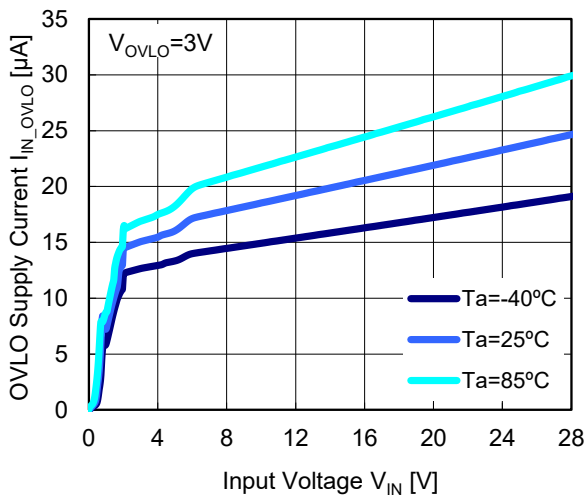

### 4) OVLO Input leakage vs. OVLO Input Voltage

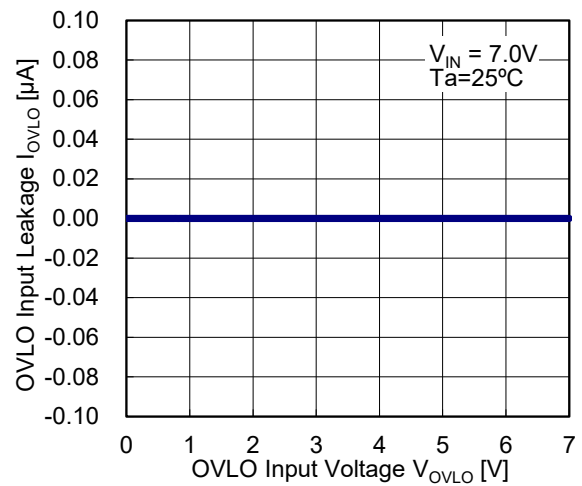



## 5) Normalized On Resistance vs. Temperature

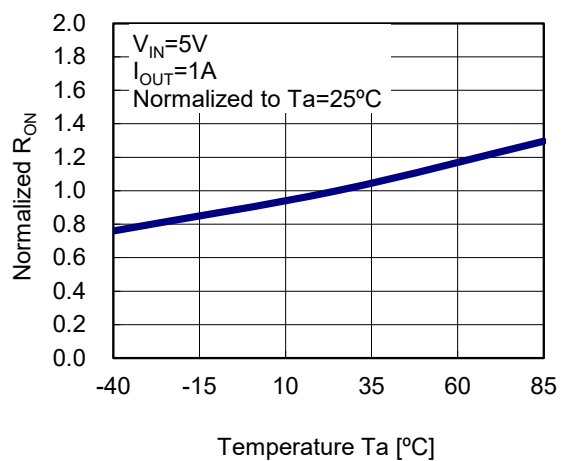

## 6) Normalized On Resistance vs. Input Voltage

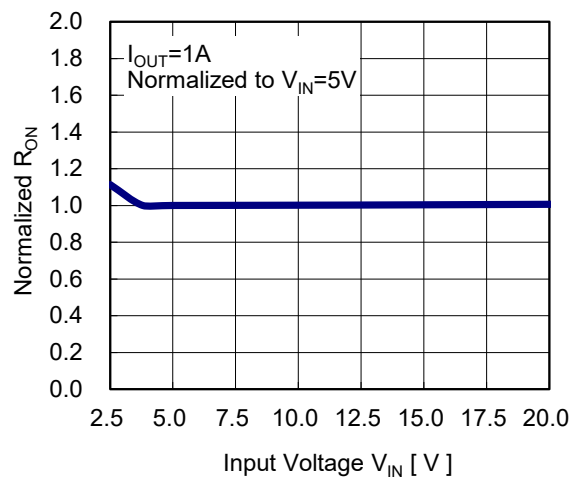

## 7) Normalized On Resistance vs. Output Current

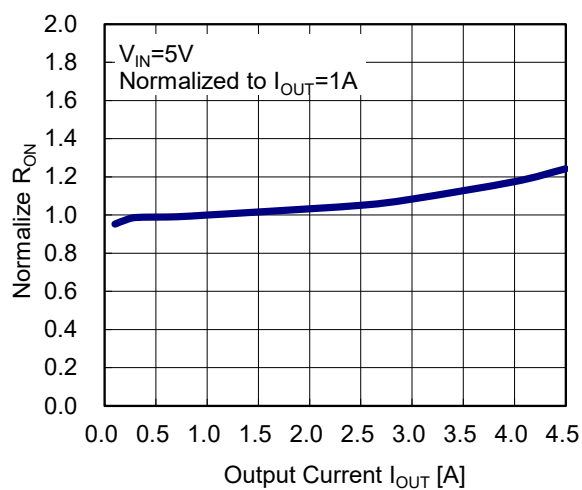

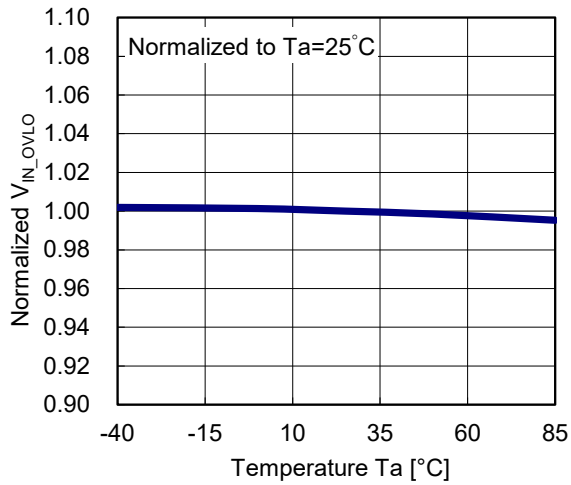
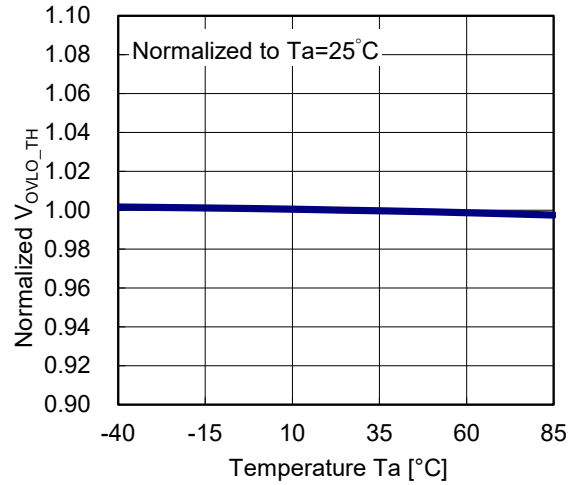
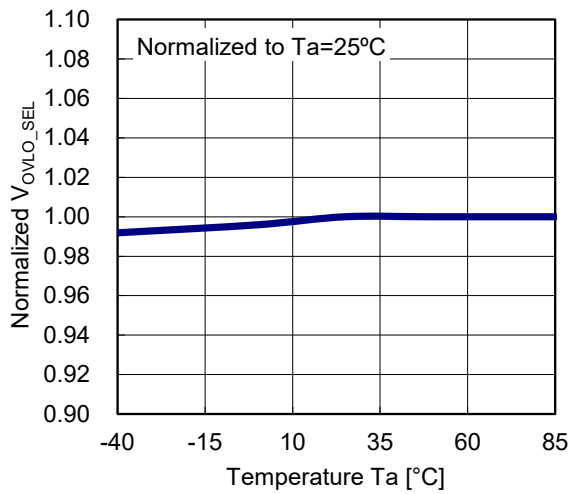
**8) Normalized Internal Fixed Preset OVLO Threshold vs. Temperature****9) Normalized OVLO set Threshold vs. Temperature****10) Normalized External OVLO Select Threshold vs. Temperature**

## 11) Normalized Debounce Time vs. Temperature

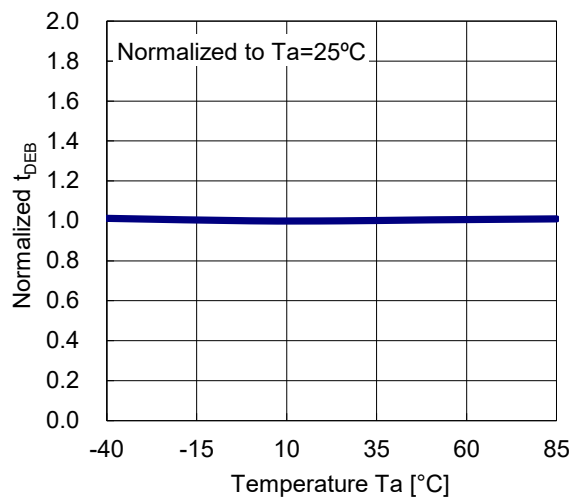

## 12) Normalized Debounce Time vs. Input Voltage

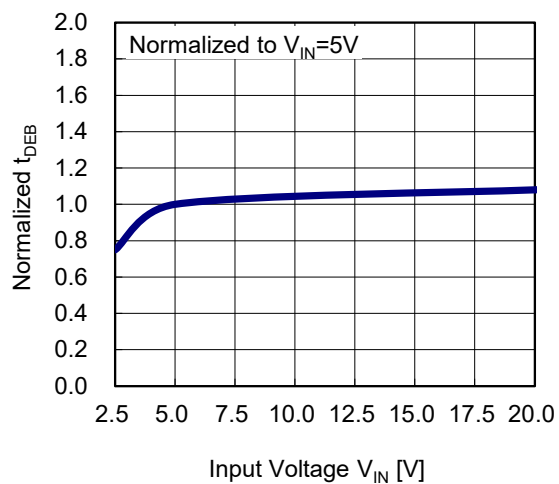

## 13) Normalized Turn On Time during Soft-Start vs. Temperature

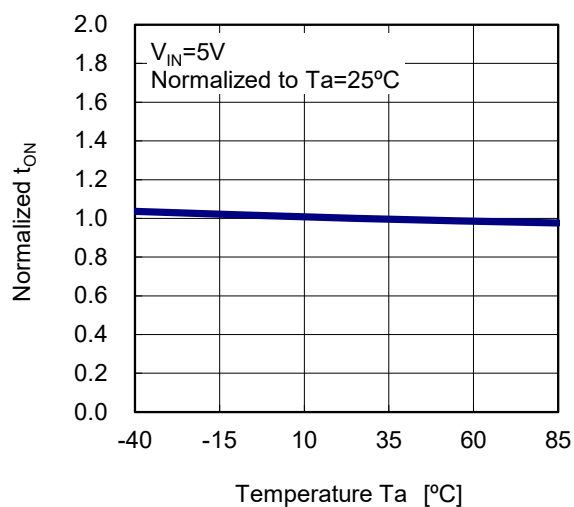

14) Power-Up Response ( $C_{OUT}$  dependence)

$R_{LOAD} = 100 \Omega$ ,  $V_{IO} = 5.0 \text{ V}$ , PG pull up resistance =  $100 \text{ k}\Omega$

15) Power-Up Response ( $R_{LOAD}$  dependence)

$C_{OUT} = 1 \mu\text{F}$ ,  $V_{IO} = 5.0 \text{ V}$ , PG pull up resistance =  $100 \text{ k}\Omega$

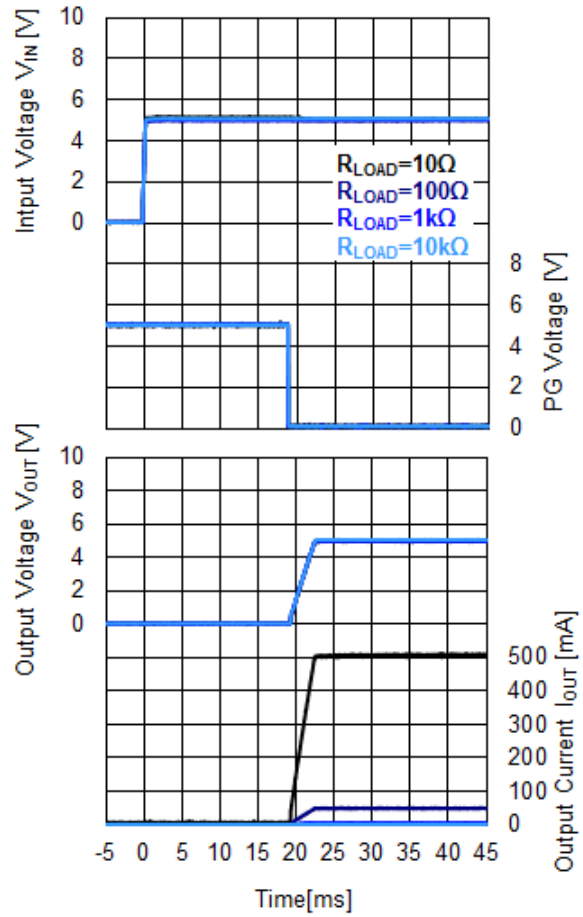
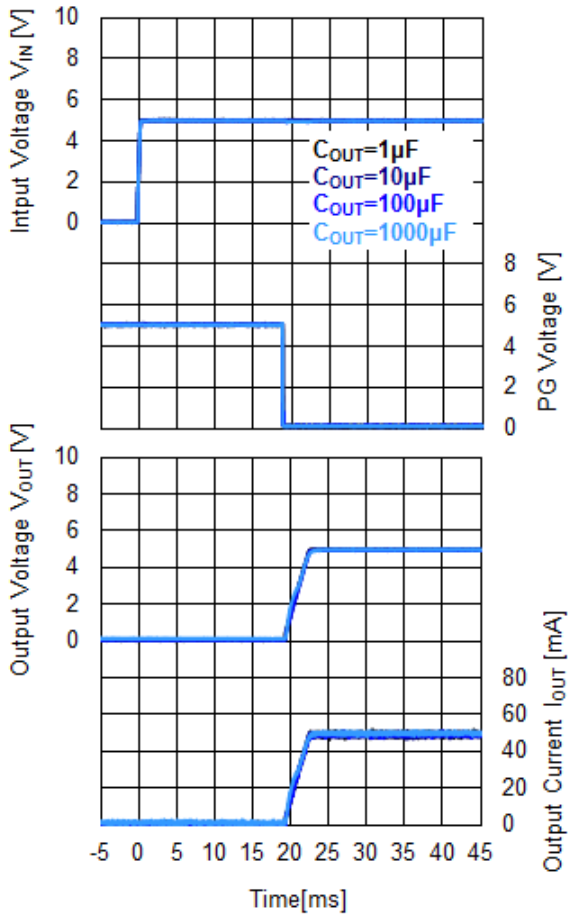

### 16) Power-Up Response ( $V_{IN}$ dependence)

$C_{OUT} = 1 \mu F$ ,  $R_{LOAD} = 100 \Omega$ ,  $V_{IO} = 5.0 V$ ,

PG pull up resistance = 100 k $\Omega$

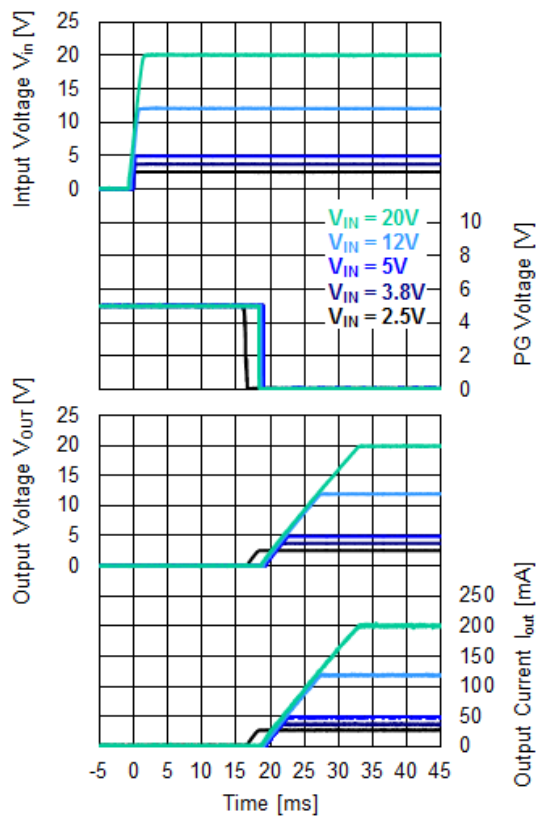

### 17) OVLO Response

$V_{OVLO} = 0 V$  ( $V_{IN\_OVLO} = 6.8 V$ ),

$R_{LOAD} = 100 \Omega$ ,  $V_{IO} = 5.0 V$ , PG pull up resistance = 100 k $\Omega$

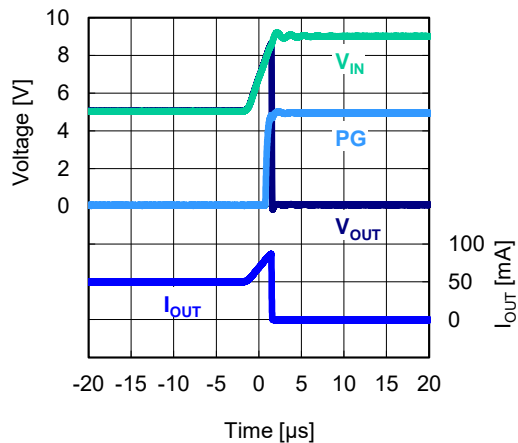

### 18) Surge Suppression

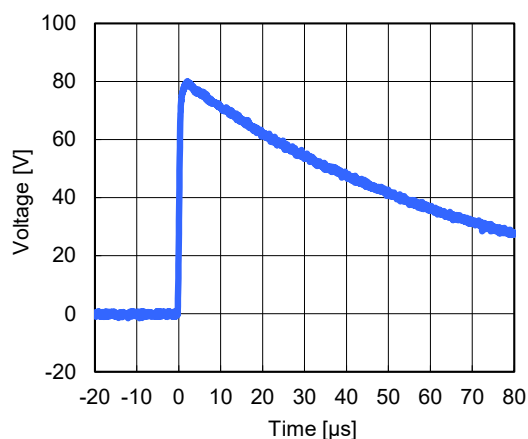

80 V Surge Test Waveform

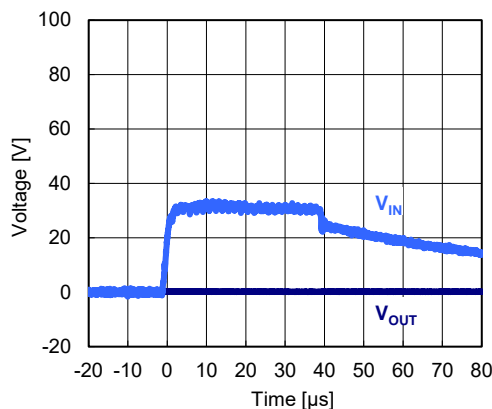

With 5560Z

The power dissipation of the package is dependent on PCB material, layout, and environmental conditions. The following conditions are used in this measurement.

**Measurement Conditions**

	<b>Standard Test Land Pattern</b>
Environment	Mounting on Board (Wind Velocity = 0 m/s)
Board Material	Glass Cloth Epoxy Plastic (Double-Sided Board)
Board Dimensions	40 mm × 40 mm × 1.6 mm
Copper Ratio	Top Side: Approx. 80% Bottom Side: Approx. 90%
Through-holes	φ 0.6 mm × 31 pcs

**Measurement Result**

(Ta = 25°C, Tjmax = 125°C)

	<b>Standard Test Land Pattern</b>
Power Dissipation	1000 mW
Thermal Resistance	$\theta_{ja} = (125 - 25^\circ\text{C}) / 1.0 \text{ W} = 100^\circ\text{C/W}$

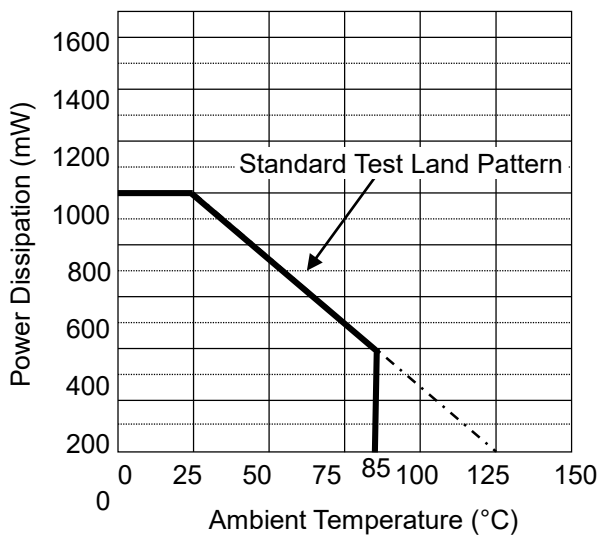

**Power Dissipation vs. Ambient Temperature**

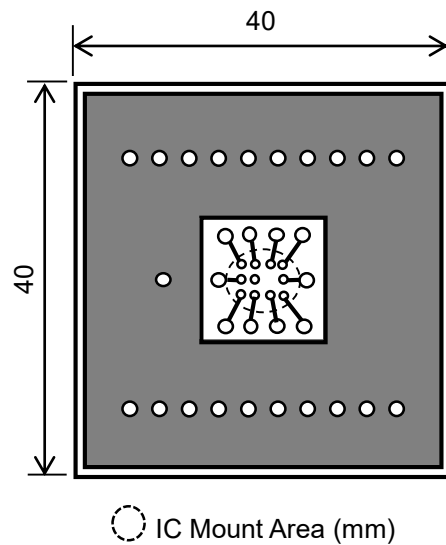

**Measurement Board Pattern**

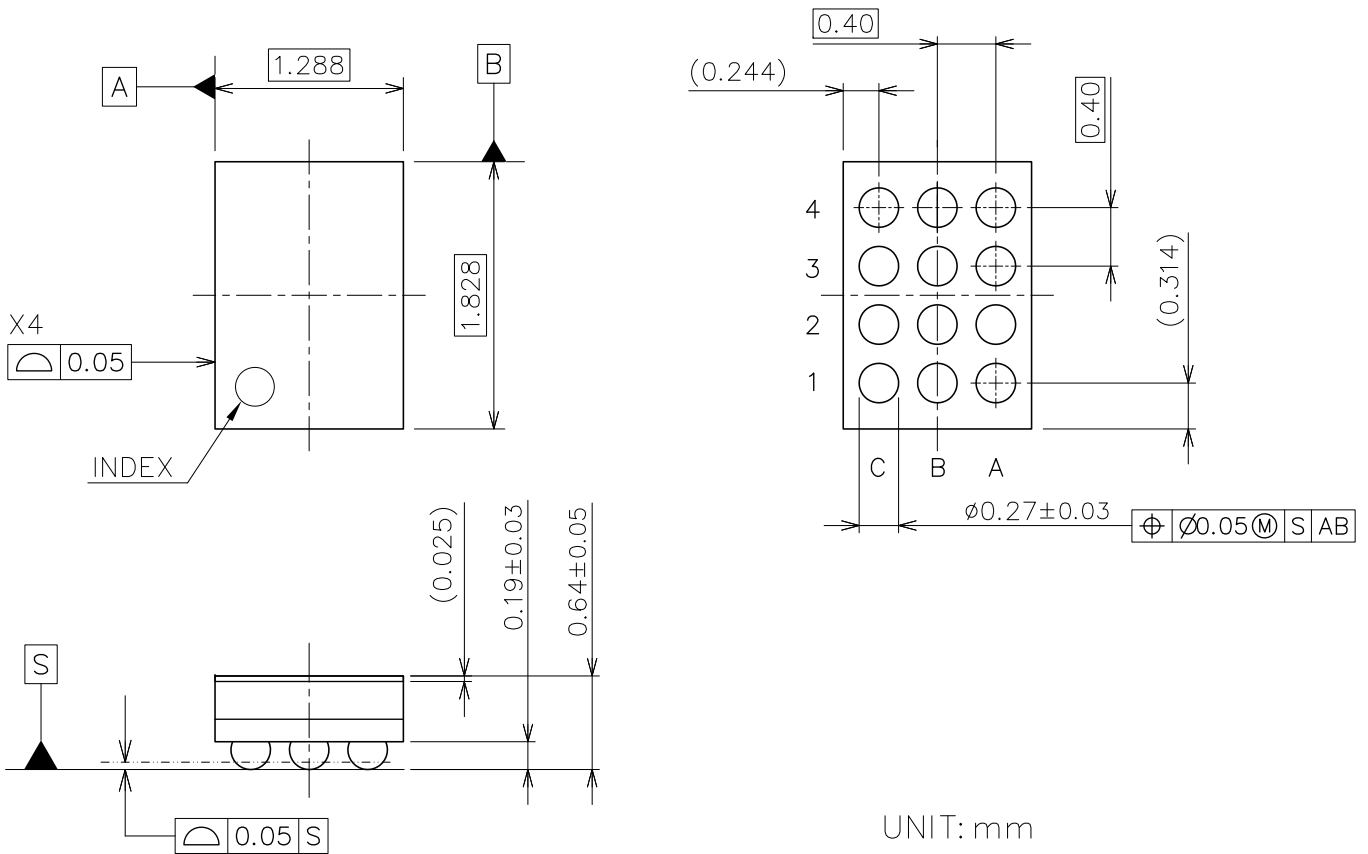

**WLCSP-12-P2 Package Dimensions**



1. The products and the product specifications described in this document are subject to change or discontinuation of production without notice for reasons such as improvement. Therefore, before deciding to use the products, please refer to our sales representatives for the latest information thereon.
2. The materials in this document may not be copied or otherwise reproduced in whole or in part without prior written consent of our company.
3. Please be sure to take any necessary formalities under relevant laws or regulations before exporting or otherwise taking out of your country the products or the technical information described herein.
4. The technical information described in this document shows typical characteristics of and example application circuits for the products. The release of such information is not to be construed as a warranty of or a grant of license under our company's or any third party's intellectual property rights or any other rights.
5. The products listed in this document are intended and designed for use as general electronic components in standard applications (office equipment, telecommunication equipment, measuring instruments, consumer electronic products, amusement equipment etc.). Those customers intending to use a product in an application requiring extreme quality and reliability, for example, in a highly specific application where the failure or misoperation of the product could result in human injury or death (aircraft, spacevehicle, nuclear reactor control system, traffic control system, automotive and transportation equipment, combustion equipment, safety devices, life support system etc.) should first contact us.
6. We are making our continuous effort to improve the quality and reliability of our products, but semiconductor products are likely to fail with certain probability. In order to prevent any injury to persons or damages to property resulting from such failure, customers should be careful enough to incorporate safety measures in their design, such as redundancy feature, fire containment feature and fail-safe feature. We do not assume any liability or responsibility for any loss or damage arising from misuse or inappropriate use of the products.
7. Anti-radiation design is not implemented in the products described in this document.
8. The X-ray exposure can influence functions and characteristics of the products. Confirm the product functions and characteristics in the evaluation stage.
9. WLCSP products should be used in light shielded environments. The light exposure can influence functions and characteristics of the products under operation or storage.
10. There can be variation in the marking when different AOI (Automated Optical Inspection) equipment is used. In the case of recognizing the marking characteristic with AOI, please contact our sales or our distributor before attempting to use AOI.
11. Please contact our sales representatives should you have any questions or comments concerning the products or the technical information.



**Nisshinbo Micro Devices Inc.**

**Official website**

<https://www.nisshinbo-microdevices.co.jp/en/>

**Purchase information**

<https://www.nisshinbo-microdevices.co.jp/en/buy/>

