

# 3.3 V/5 V ECL Dual Differential Data and Clock D Flip-Flop With Set and Reset



ON Semiconductor®

[www.onsemi.com](http://www.onsemi.com)

## MC10EP29, MC100EP29

### Description

The MC10/100EP29 is a dual master–slave flip–flop. The device features fully differential Data and Clock inputs as well as outputs. The MC10/100EP29 is functionally equivalent to the MC10/100EL29. Data enters the master latch when the clock is LOW and transfers to the slave upon a positive transition on the clock input.

The differential inputs have special circuitry which ensures device stability under open input conditions. When both differential inputs are left open the D input will pull down to  $V_{EE}$  and the  $\bar{D}$  input will bias around  $V_{CC}/2$ . The outputs will go to a defined state, however the state will be random based on how the flip flop powers up.

Both flip flops feature asynchronous, overriding Set and Reset inputs. Note that the Set and Reset inputs cannot both be HIGH simultaneously.

The  $V_{BB}$  pin, an internally generated voltage supply, is available to this device only. For single-ended input conditions, the unused differential input is connected to  $V_{BB}$  as a switching reference voltage.  $V_{BB}$  may also rebias AC coupled inputs. When used, decouple  $V_{BB}$  and  $V_{CC}$  via a 0.01  $\mu$ F capacitor and limit current sourcing or sinking to 0.5 mA. When not used,  $V_{BB}$  should be left open.

The 100 Series contains temperature compensation.

### Features

- Maximum Frequency > 3 GHz Typical
- 500 ps Typical Propagation Delays
- PECL Mode Operating Range:  $V_{CC} = 3.0$  V to 5.5 V with  $V_{EE} = 0$  V
- NECL Mode Operating Range:  $V_{CC} = 0$  V with  $V_{EE} = -3.0$  V to  $-5.5$  V
- Open Input Default State
- Safety Clamp on Inputs
- These are Pb–Free Devices

### MARKING DIAGRAM\*

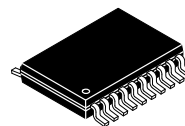

TSSOP-20  
DT SUFFIX  
CASE 948E

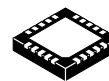
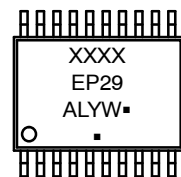

QFN-20  
MN SUFFIX  
CASE 485E

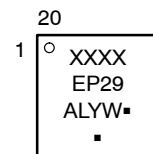

- XXXX = MC10 or 100
- A = Assembly Location
- L = Wafer Lot
- Y = Year
- W = Work Week
- = Pb–Free Package

(Note: Microdot may be in either location)

\*For additional marking information, refer to Application Note [AND8002/D](#).

### ORDERING INFORMATION

Device	Package	Shipping†
MC10EP29DTG	TSSOP-20 (Pb–Free)	75 Units / Tube
MC100EP29DTG	TSSOP-20 (Pb–Free)	75 Units / Tube
MC100EP29DTR2G	TSSOP-20 (Pb–Free)	2500 / Tape & Reel
MC100EP29MNG	QFN-20 (Pb–Free)	92 Units / Tube

†For information on tape and reel specifications, including part orientation and tape sizes, please refer to our Tape and Reel Packaging Specifications Brochure, [BRD8011/D](#).

# MC10EP29, MC100EP29

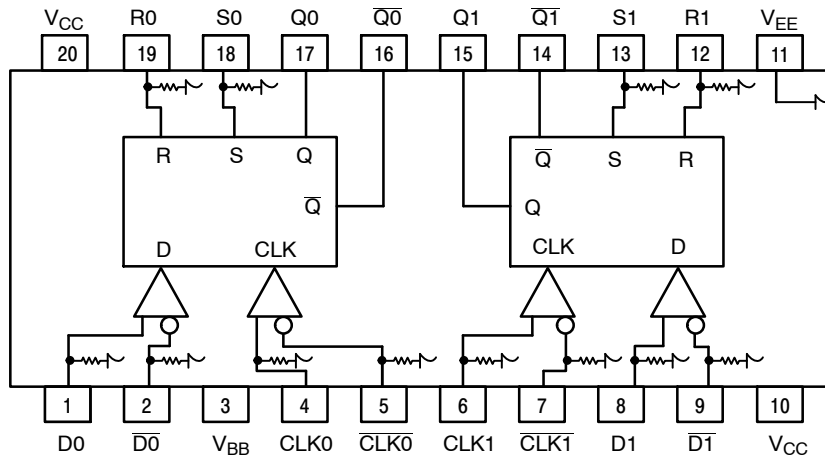

Warning: All  $V_{CC}$  and  $V_{EE}$  pins must be externally connected to Power Supply to guarantee proper operation.

**Figure 1. 20-Lead Pinout (Top View) and Logic Diagram**

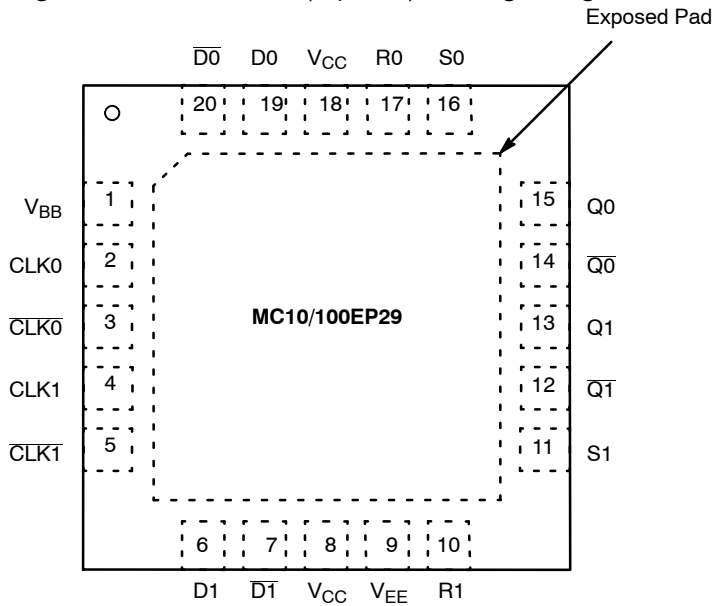

NOTE: The Exposed Pad (EP) on package bottom must be attached to a heat-sinking conduit. The Exposed Pad may only be electrically connected to  $V_{EE}$ .

**Figure 1. QFN-20 Pinout (Top View)**

**Table 1. PIN DESCRIPTION**

Pin	Function
$D0^*$ , $\overline{D0}^*$ ; $D1^*$ , $\overline{D1}^*$	ECL Differential Data Inputs
$R0^*$ , $R1^*$	ECL Reset Inputs
$CLK0^*$ , $\overline{CLK0}^*$	ECL Differential Clock Inputs
$CLK1^*$ , $\overline{CLK1}^*$	ECL Differential Clock Inputs
$S0^*$ , $S1^*$	ECL Set Inputs
$Q0$ , $\overline{Q0}$ ; $Q1$ , $\overline{Q1}$	ECL Differential Data Outputs
$V_{BB}$	Reference Voltage Output
$V_{CC}$	Positive Supply
$V_{EE}$	Negative Supply
EP	Exposed Pad

\*Pins will default LOW when left open.

**Table 2. TRUTH TABLE**

R	S	D	CLK	Q	$\overline{Q}$
L	L	L	Z	L	H
L	L	H	Z	H	L
H	L	X	X	L	H
L	H	X	X	H	L
H	H	X	X	Undef	Undef

Z = LOW to HIGH Transition  
X = Don't Care

# MC10EP29, MC100EP29

**Table 3. ATTRIBUTES**

Characteristics	Value
Internal Input Pulldown Resistor	75 k $\Omega$
Internal Input Pullup Resistor	N/A
ESD Protection Human Body Model Machine Model Charged Device Model	> 2 kV > 100 V > 2 kV
Moisture Sensitivity, Indefinite Time Out of Drypack (Note 1)	Pb-Free Pkg
TSSOP-20 QFN-20	Level 3 Level 1
Flammability Rating Oxygen Index: 28 to 34	UL 94 V-0 @ 0.125 in
Transistor Count	383 Devices
Meets or exceeds JEDEC Spec EIA/JESD78 IC Latchup Test	

1. For additional information, see Application Note [AND8003/D](#).

**Table 4. MAXIMUM RATINGS**

Symbol	Parameter	Condition 1	Condition 2	Rating	Unit
V <sub>CC</sub>	PECL Mode Power Supply	V <sub>EE</sub> = 0 V		6	V
V <sub>EE</sub>	NECL Mode Power Supply	V <sub>CC</sub> = 0 V		-6	V
V <sub>I</sub>	PECL Mode Input Voltage NECL Mode Input Voltage	V <sub>EE</sub> = 0 V V <sub>CC</sub> = 0 V	V <sub>I</sub> $\leq$ V <sub>CC</sub> V <sub>I</sub> $\geq$ V <sub>EE</sub>	6 -6	V V
I <sub>out</sub>	Output Current	Continuous Surge		50 100	mA mA
I <sub>BB</sub>	V <sub>BB</sub> Sink/Source			$\pm$ 0.5	mA
T <sub>A</sub>	Operating Temperature Range			-40 to +85	$^{\circ}$ C
T <sub>stg</sub>	Storage Temperature Range			-65 to +150	$^{\circ}$ C
$\theta_{JA}$	Thermal Resistance (Junction-to-Ambient)	0 lfpm 500 lfpm	20 TSSOP 20 TSSOP	140 100	$^{\circ}$ C/W $^{\circ}$ C/W
$\theta_{JC}$	Thermal Resistance (Junction-to-Case)	Standard Board	20 TSSOP	23 to 41	$^{\circ}$ C/W
$\theta_{JA}$	Thermal Resistance (Junction-to-Ambient)	0 lfpm 500 lfpm	QFN-20 QFN-20	47 33	$^{\circ}$ C/W $^{\circ}$ C/W
$\theta_{JC}$	Thermal Resistance (Junction-to-Case)	Standard Board	QFN-20	18	$^{\circ}$ C/W
T <sub>sol</sub>	Wave Solder (Pb-Free)			265	$^{\circ}$ C

Stresses exceeding those listed in the Maximum Ratings table may damage the device. If any of these limits are exceeded, device functionality should not be assumed, damage may occur and reliability may be affected.

## MC10EP29, MC100EP29

**Table 5. 10EP DC CHARACTERISTICS, PECL  $V_{CC} = 3.3\text{ V}$ ,  $V_{EE} = 0\text{ V}$  (Note 2)**

Symbol	Characteristic	-40°C			25°C			85°C			Unit
		Min	Typ	Max	Min	Typ	Max	Min	Typ	Max	
$I_{EE}$	Power Supply Current	35	46	55	37	48	57	40	49	60	mA
$V_{OH}$	Output HIGH Voltage (Note 3)	2165	2290	2415	2230	2355	2480	2290	2415	2540	mV
$V_{OL}$	Output LOW Voltage (Note 3)	1365	1490	1615	1430	1555	1680	1490	1615	1740	mV
$V_{IH}$	Input HIGH Voltage (Single-Ended)	2090		2415	2155		2480	2215		2540	mV
$V_{IL}$	Input LOW Voltage (Single-Ended)	1365		1690	1460		1755	1490		1815	mV
$V_{BB}$	Output Voltage Reference	1790	1890	1990	1855	1955	2055	1915	2015	2115	mV
$V_{IHCMR}$	Input HIGH Voltage Common Mode Range (Differential Configuration) (Note 4)	2.0		3.3	2.0		3.3	2.0		3.3	V
$I_{IH}$	Input HIGH Current			150			150			150	$\mu\text{A}$
$I_{IL}$	Input LOW Current	0.5			0.5			0.5			$\mu\text{A}$

NOTE: Device will meet the specifications after thermal equilibrium has been established when mounted in a test socket or printed circuit board with maintained transverse airflow greater than 500 lfm.

2. Input and output parameters vary 1:1 with  $V_{CC}$ .  $V_{EE}$  can vary +0.3 V to -2.2 V.

3. All loading with 50  $\Omega$  to  $V_{CC} - 2.0\text{ V}$ .

4.  $V_{IHCMR}$  min varies 1:1 with  $V_{EE}$ .  $V_{IHCMR}$  max varies 1:1 with  $V_{CC}$ . The  $V_{IHCMR}$  range is referenced to the most positive side of the differential input signal.

**Table 6. 10EP DC CHARACTERISTICS, PECL  $V_{CC} = 5.0\text{ V}$ ,  $V_{EE} = 0\text{ V}$  (Note 5)**

Symbol	Characteristic	-40°C			25°C			85°C			Unit
		Min	Typ	Max	Min	Typ	Max	Min	Typ	Max	
$I_{EE}$	Power Supply Current	35	46	55	37	48	57	40	49	60	mA
$V_{OH}$	Output HIGH Voltage (Note 6)	3865	3990	4115	3930	4055	4180	3990	4115	4240	mV
$V_{OL}$	Output LOW Voltage (Note 6)	3065	3190	3315	3130	3255	3380	3190	3315	3440	mV
$V_{IH}$	Input HIGH Voltage (Single-Ended)	3790		4115	3855		4180	3915		4240	mV
$V_{IL}$	Input LOW Voltage (Single-Ended)	3065		3390	3130		3455	3190		3515	mV
$V_{BB}$	Output Voltage Reference	3490	3590	3690	3555	3655	3755	3615	3715	3815	mV
$V_{IHCMR}$	Input HIGH Voltage Common Mode Range (Differential Configuration) (Note 7)	2.0		5.0	2.0		5.0	2.0		5.0	V
$I_{IH}$	Input HIGH Current			150			150			150	$\mu\text{A}$
$I_{IL}$	Input LOW Current	0.5			0.5			0.5			$\mu\text{A}$

NOTE: Device will meet the specifications after thermal equilibrium has been established when mounted in a test socket or printed circuit board with maintained transverse airflow greater than 500 lfm.

5. Input and output parameters vary 1:1 with  $V_{CC}$ .  $V_{EE}$  can vary +2.0 V to -0.5 V.

6. All loading with 50  $\Omega$  to  $V_{CC} - 2.0\text{ V}$ .

7.  $V_{IHCMR}$  min varies 1:1 with  $V_{EE}$ .  $V_{IHCMR}$  max varies 1:1 with  $V_{CC}$ . The  $V_{IHCMR}$  range is referenced to the most positive side of the differential input signal.

## MC10EP29, MC100EP29

**Table 7. 10EP DC CHARACTERISTICS, NECL**  $V_{CC} = 0\text{ V}$ ;  $V_{EE} = -5.5\text{ V}$  to  $-3.0\text{ V}$  (Note 8)

Symbol	Characteristic	-40°C			25°C			85°C			Unit
		Min	Typ	Max	Min	Typ	Max	Min	Typ	Max	
$I_{EE}$	Power Supply Current	35	46	55	37	48	57	40	49	60	mA
$V_{OH}$	Output HIGH Voltage (Note 9)	-1135	-1010	-885	-1070	-945	-820	-1010	-885	-760	mV
$V_{OL}$	Output LOW Voltage (Note 9)	-1935	-1810	-1685	-1870	-1745	-1620	-1810	-1685	-1560	mV
$V_{IH}$	Input HIGH Voltage (Single-Ended)	-1210		-885	-1145		-820	-1085		-760	mV
$V_{IL}$	Input LOW Voltage (Single-Ended)	-1935		-1610	-1870		-1545	-1810		-1485	mV
$V_{BB}$	Output Voltage Reference	-1510	-1410	-1310	-1445	-1345	-1245	-1385	-1285	-1185	mV
$V_{IHCMR}$	Input HIGH Voltage Common Mode Range (Differential Configuration) (Note 10)	$V_{EE} + 2.0$		0.0	$V_{EE} + 2.0$		0.0	$V_{EE} + 2.0$		0.0	V
$I_{IH}$	Input HIGH Current			150			150			150	$\mu\text{A}$
$I_{IL}$	Input LOW Current	0.5			0.5			0.5			$\mu\text{A}$

NOTE: Device will meet the specifications after thermal equilibrium has been established when mounted in a test socket or printed circuit board with maintained transverse airflow greater than 500 lpm.

8. Input and output parameters vary 1:1 with  $V_{CC}$ .

9. All loading with  $50\ \Omega$  to  $V_{CC} - 2.0\text{ V}$ .

10.  $V_{IHCMR}$  min varies 1:1 with  $V_{EE}$ .  $V_{IHCMR}$  max varies 1:1 with  $V_{CC}$ . The  $V_{IHCMR}$  range is referenced to the most positive side of the differential input signal.

**Table 8. 100EP DC CHARACTERISTICS, PECL**  $V_{CC} = 3.3\text{ V}$ ,  $V_{EE} = 0\text{ V}$  (Note 11)

Symbol	Characteristic	-40°C			25°C			85°C			Unit
		Min	Typ	Max	Min	Typ	Max	Min	Typ	Max	
$I_{EE}$	Power Supply Current	35	46	55	37	48	57	40	49	60	mA
$V_{OH}$	Output HIGH Voltage (Note 12)	2155	2280	2405	2155	2280	2405	2155	2280	2405	mV
$V_{OL}$	Output LOW Voltage (Note 12)	1305	1480	1605	1305	1480	1605	1305	1480	1605	mV
$V_{IH}$	Input HIGH Voltage (Single-Ended)	2075		2420	2075		2420	2075		2420	mV
$V_{IL}$	Input LOW Voltage (Single-Ended)	1305		1675	1305		1675	1305		1675	mV
$V_{BB}$	Output Voltage Reference	1775	1875	1975	1775	1875	1975	1775	1875	1975	mV
$V_{IHCMR}$	Input HIGH Voltage Common Mode Range (Differential Configuration) (Note 13)	2.0		3.3	2.0		3.3	2.0		3.3	V
$I_{IH}$	Input HIGH Current			150			150			150	$\mu\text{A}$
$I_{IL}$	Input LOW Current	0.5			0.5			0.5			$\mu\text{A}$

NOTE: Device will meet the specifications after thermal equilibrium has been established when mounted in a test socket or printed circuit board with maintained transverse airflow greater than 500 lpm.

11. Input and output parameters vary 1:1 with  $V_{CC}$ .  $V_{EE}$  can vary  $+0.3\text{ V}$  to  $-2.2\text{ V}$ .

12. All loading with  $50\ \Omega$  to  $V_{CC} - 2.0\text{ V}$ .

13.  $V_{IHCMR}$  min varies 1:1 with  $V_{EE}$ .  $V_{IHCMR}$  max varies 1:1 with  $V_{CC}$ . The  $V_{IHCMR}$  range is referenced to the most positive side of the differential input signal.

## MC10EP29, MC100EP29

**Table 9. 100EP DC CHARACTERISTICS, PECL**  $V_{CC} = 5.0\text{ V}$ ,  $V_{EE} = 0\text{ V}$  (Note 14)

Symbol	Characteristic	-40°C			25°C			85°C			Unit
		Min	Typ	Max	Min	Typ	Max	Min	Typ	Max	
$I_{EE}$	Power Supply Current	35	46	55	37	48	57	40	49	60	mA
$V_{OH}$	Output HIGH Voltage (Note 15)	3855	3980	4105	3855	3980	4105	3855	3980	4105	mV
$V_{OL}$	Output LOW Voltage (Note 15)	3005	3180	3305	3005	3180	3305	3005	3180	3305	mV
$V_{IH}$	Input HIGH Voltage (Single-Ended)	3775		4120	3775		4120	3775		4120	mV
$V_{IL}$	Input LOW Voltage (Single-Ended)	3005		3375	3005		3375	3005		3375	mV
$V_{BB}$	Output Voltage Reference	3475	3575	3675	3475	3575	3675	3475	3575	3675	mV
$V_{IHCMR}$	Input HIGH Voltage Common Mode Range (Differential Configuration) (Note 16)	2.0		5.0	2.0		5.0	2.0		5.0	V
$I_{IH}$	Input HIGH Current			150			150			150	$\mu\text{A}$
$I_{IL}$	Input LOW Current	0.5			0.5			0.5			$\mu\text{A}$

NOTE: Device will meet the specifications after thermal equilibrium has been established when mounted in a test socket or printed circuit board with maintained transverse airflow greater than 500 lfm.

14. Input and output parameters vary 1:1 with  $V_{CC}$ .  $V_{EE}$  can vary +2.0 V to -0.5 V.

15. All loading with 50  $\Omega$  to  $V_{CC} - 2.0\text{ V}$ .

16.  $V_{IHCMR}$  min varies 1:1 with  $V_{EE}$ ,  $V_{IHCMR}$  max varies 1:1 with  $V_{CC}$ . The  $V_{IHCMR}$  range is referenced to the most positive side of the differential input signal.

**Table 10. 100EP DC CHARACTERISTICS, NECL**  $V_{CC} = 0\text{ V}$ ;  $V_{EE} = -5.5\text{ V}$  to  $-3.0\text{ V}$  (Note 17)

Symbol	Characteristic	-40°C			25°C			85°C			Unit
		Min	Typ	Max	Min	Typ	Max	Min	Typ	Max	
$I_{EE}$	Power Supply Current	35	46	55	37	48	57	40	49	60	mA
$V_{OH}$	Output HIGH Voltage (Note 18)	-1145	-1020	-895	-1145	-1020	-895	-1145	-1020	-895	mV
$V_{OL}$	Output LOW Voltage (Note 18)	-1995	-1820	-1695	-1995	-1820	-1695	-1995	-1820	-1695	mV
$V_{IH}$	Input HIGH Voltage (Single-Ended)	-1225		-880	-1225		-880	-1225		-880	mV
$V_{IL}$	Input LOW Voltage (Single-Ended)	-1995		-1625	-1995		-1625	-1995		-1625	mV
$V_{BB}$	Output Voltage Reference	-1525	-1425	-1325	-1525	-1425	-1325	-1525	-1425	-1325	mV
$V_{IHCMR}$	Input HIGH Voltage Common Mode Range (Differential Configuration) (Note 19)	$V_{EE} + 2.0$		0.0	$V_{EE} + 2.0$		0.0	$V_{EE} + 2.0$		0.0	V
$I_{IH}$	Input HIGH Current			150			150			150	$\mu\text{A}$
$I_{IL}$	Input LOW Current	0.5			0.5			0.5			$\mu\text{A}$

NOTE: Device will meet the specifications after thermal equilibrium has been established when mounted in a test socket or printed circuit board with maintained transverse airflow greater than 500 lfm.

17. Input and output parameters vary 1:1 with  $V_{CC}$ .

18. All loading with 50  $\Omega$  to  $V_{CC} - 2.0\text{ V}$ .

19.  $V_{IHCMR}$  min varies 1:1 with  $V_{EE}$ ,  $V_{IHCMR}$  max varies 1:1 with  $V_{CC}$ . The  $V_{IHCMR}$  range is referenced to the most positive side of the differential input signal.

# MC10EP29, MC100EP29

**Table 11. AC CHARACTERISTICS**  $V_{CC} = 0\text{ V}$ ;  $V_{EE} = -3.0\text{ V to } -5.5\text{ V}$  or  $V_{CC} = 3.0\text{ V to } 5.5\text{ V}$ ;  $V_{EE} = 0\text{ V}$  (Note 20)

Symbol	Characteristic	-40°C			25°C			85°C			Unit
		Min	Typ	Max	Min	Typ	Max	Min	Typ	Max	
$f_{max}$	Maximum Frequency (See Figure 2 $F_{max}/JITTER$ )		> 3.0			> 3.0			> 3.0		GHz
$t_{PLH}$ , $t_{PHL}$	Propagation Delay to Output Differential S R	300 275 300	380 380 400	450 475 500	350 300 325	420 400 420	500 500 525	400 350 375	470 450 470	550 550 575	ps
$t_S$ $t_H$	Setup Time Hold Time	100 100	20 20		100 100	20 20		100 100	20 20		ps
$t_{RR}/t_{RR2}$	Set/Reset Recovery	150	80		150	80		150	80		ps
$t_{PW}$	Minimum Pulse Width Set, Reset	500	300		500	300		500	300		ps
$t_{JITTER}$	Cycle-to-Cycle Jitter (See Figure 2 $F_{max}/JITTER$ )		0.2	< 1		0.2	< 1		0.2	< 1	ps
$V_{PP}$	Input Voltage Swing (Note 21)	150	800	1200	150	800	1200	150	800	1200	mV
$t_r$ $t_f$	Output Rise/Fall Times (20% - 80%)	100	180	250	150	210	300	175	230	325	ps

NOTE: Device will meet the specifications after thermal equilibrium has been established when mounted in a test socket or printed circuit board with maintained transverse airflow greater than 500 lpm.

20. Measured using a 750 mV source, 50% duty cycle clock source. All loading with 50  $\Omega$  to  $V_{CC} - 2.0\text{ V}$ .

21.  $V_{PP}(\text{min})$  is the minimum input swing for which AC parameters are guaranteed.

Product parametric performance is indicated in the Electrical Characteristics for the listed test conditions, unless otherwise noted. Product performance may not be indicated by the Electrical Characteristics if operated under different conditions.

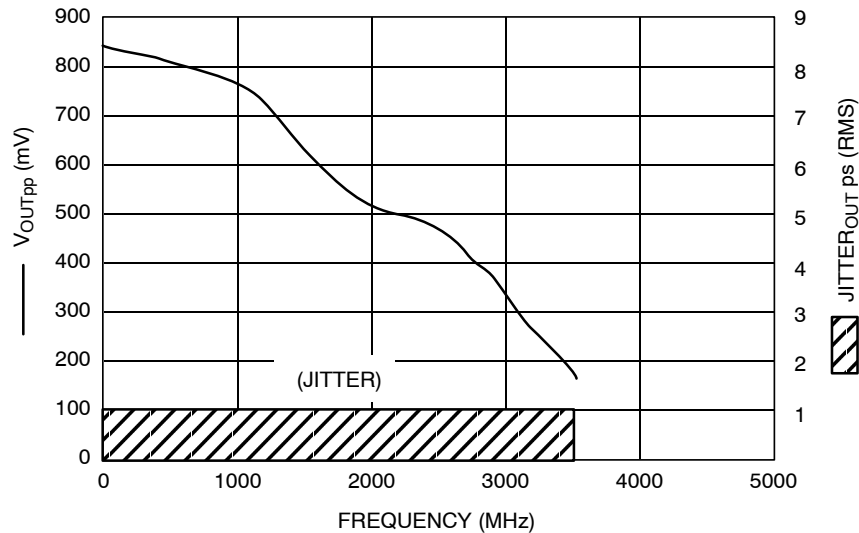

**Figure 2.  $F_{max}/Jitter$**

## MC10EP29, MC100EP29



**Figure 3. Typical Termination for Output Driver and Device Evaluation**  
(See Application Note [AND8020/D](#) – Termination of ECL Logic Devices.)

### Resource Reference of Application Notes

- AN1405/D** – ECL Clock Distribution Techniques
- AN1406/D** – Designing with PECL (ECL at +5.0 V)
- AN1503/D** – ECLinPS™ I/O SPiCE Modeling Kit
- AN1504/D** – Metastability and the ECLinPS Family
- AN1568/D** – Interfacing Between LVDS and ECL
- AN1672/D** – The ECL Translator Guide
- AND8001/D** – Odd Number Counters Design
- AND8002/D** – Marking and Date Codes
- AND8020/D** – Termination of ECL Logic Devices
- AND8066/D** – Interfacing with ECLinPS
- AND8090/D** – AC Characteristics of ECL Devices



# MECHANICAL CASE OUTLINE

## PACKAGE DIMENSIONS

ON Semiconductor®



SCALE 2:1

QFN20, 4x4, 0.5P  
CASE 485E  
ISSUE C

DATE 13 FEB 2018



### SOLDERING FOOTPRINT\*



DIMENSIONS: MILLIMETERS

\*For additional information on our Pb-Free strategy and soldering details, please download the ON Semiconductor Soldering and Mounting Techniques Reference Manual, SOLDERRM/D.



### DETAIL B ALTERNATE CONSTRUCTIONS



### DETAIL A OPTIONAL CONSTRUCTIONS

#### NOTES:

1. DIMENSIONING AND TOLERANCING PER ASME Y14.5M, 1994.
2. CONTROLLING DIMENSION: MILLIMETERS.
3. DIMENSION b APPLIES TO PLATED TERMINAL AND IS MEASURED BETWEEN 0.15 AND 0.30 MM FROM THE TERMINAL TIP.
4. COPLANARITY APPLIES TO THE EXPOSED PAD AS WELL AS THE TERMINALS.

MILLIMETERS		
DIM	MIN	MAX
A	0.80	1.00
A1	---	0.05
A3	0.20	REF
b	0.20	0.30
D	4.00 BSC	
D2	2.60	2.90
E	4.00 BSC	
E2	2.60	2.90
e	0.50 BSC	
K	0.20 REF	
L	0.35	0.45
L1	0.00	0.15

### GENERIC MARKING DIAGRAM\*

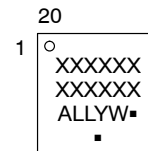

- XXXXXX= Specific Device Code
- A = Assembly Location
- LL = Wafer Lot
- Y = Year
- W = Work Week
- = Pb-Free Package

(Note: Microdot may be in either location)

\*This information is generic. Please refer to device data sheet for actual part marking. Pb-Free indicator, "G" or microdot "▪", may or may not be present. Some products may not follow the Generic Marking.

<b>DOCUMENT NUMBER:</b>	<b>98AON03163D</b>	Electronic versions are uncontrolled except when accessed directly from the Document Repository. Printed versions are uncontrolled except when stamped "CONTROLLED COPY" in red.
<b>DESCRIPTION:</b>	<b>QFN20, 4X4, 0.5P</b>	<b>PAGE 1 OF 1</b>

ON Semiconductor and ON are trademarks of Semiconductor Components Industries, LLC dba ON Semiconductor or its subsidiaries in the United States and/or other countries. ON Semiconductor reserves the right to make changes without further notice to any products herein. ON Semiconductor makes no warranty, representation or guarantee regarding the suitability of its products for any particular purpose, nor does ON Semiconductor assume any liability arising out of the application or use of any product or circuit, and specifically disclaims any and all liability, including without limitation special, consequential or incidental damages. ON Semiconductor does not convey any license under its patent rights nor the rights of others.

# MECHANICAL CASE OUTLINE

## PACKAGE DIMENSIONS

ON Semiconductor®



TSSOP-20 WB  
CASE 948E  
ISSUE D

DATE 17 FEB 2016

SCALE 2:1



NOTES:

1. DIMENSIONING AND TOLERANCING PER ANSI Y14.5M, 1982.
2. CONTROLLING DIMENSION: MILLIMETER.
3. DIMENSION A DOES NOT INCLUDE MOLD FLASH, PROTRUSIONS OR GATE BURRS. MOLD FLASH OR GATE BURRS SHALL NOT EXCEED 0.15 (0.006) PER SIDE.
4. DIMENSION B DOES NOT INCLUDE INTERLEAD FLASH OR PROTRUSION. INTERLEAD FLASH OR PROTRUSION SHALL NOT EXCEED 0.25 (0.010) PER SIDE.
5. DIMENSION K DOES NOT INCLUDE DAMBAR PROTRUSION. ALLOWABLE DAMBAR PROTRUSION SHALL BE 0.08 (0.003) TOTAL IN EXCESS OF THE K DIMENSION AT MAXIMUM MATERIAL CONDITION.
6. TERMINAL NUMBERS ARE SHOWN FOR REFERENCE ONLY.
7. DIMENSION A AND B ARE TO BE DETERMINED AT DATUM PLANE -W-.

DIM	MILLIMETERS		INCHES	
	MIN	MAX	MIN	MAX
A	6.40	6.60	0.252	0.260
B	4.30	4.50	0.169	0.177
C	---	1.20	---	0.047
D	0.05	0.15	0.002	0.006
F	0.50	0.75	0.020	0.030
G	0.65 BSC		0.026 BSC	
H	0.27	0.37	0.011	0.015
J	0.09	0.20	0.004	0.008
J1	0.09	0.16	0.004	0.006
K	0.19	0.30	0.007	0.012
K1	0.19	0.25	0.007	0.010
L	6.40 BSC		0.252 BSC	
M	0°	8°	0°	8°

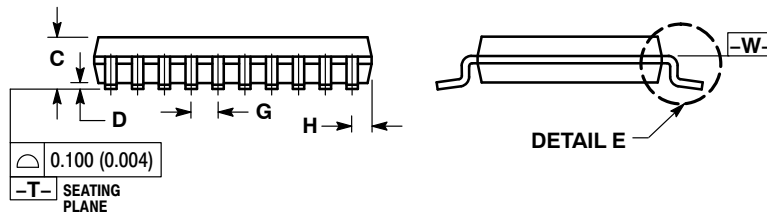

SOLDERING FOOTPRINT



GENERIC MARKING DIAGRAM\*



- A = Assembly Location
- L = Wafer Lot
- Y = Year
- W = Work Week
- = Pb-Free Package

(Note: Microdot may be in either location)

\*This information is generic. Please refer to device data sheet for actual part marking. Pb-Free indicator, "G" or microdot "▪", may or may not be present.

DOCUMENT NUMBER:	98ASH70169A	Electronic versions are uncontrolled except when accessed directly from the Document Repository. Printed versions are uncontrolled except when stamped "CONTROLLED COPY" in red.
DESCRIPTION:	TSSOP-20 WB	PAGE 1 OF 1

ON Semiconductor and ON are trademarks of Semiconductor Components Industries, LLC dba ON Semiconductor or its subsidiaries in the United States and/or other countries. ON Semiconductor reserves the right to make changes without further notice to any products herein. ON Semiconductor makes no warranty, representation or guarantee regarding the suitability of its products for any particular purpose, nor does ON Semiconductor assume any liability arising out of the application or use of any product or circuit, and specifically disclaims any and all liability, including without limitation special, consequential or incidental damages. ON Semiconductor does not convey any license under its patent rights nor the rights of others.

ON Semiconductor and  are trademarks of Semiconductor Components Industries, LLC dba ON Semiconductor or its subsidiaries in the United States and/or other countries. ON Semiconductor owns the rights to a number of patents, trademarks, copyrights, trade secrets, and other intellectual property. A listing of ON Semiconductor's product/patent coverage may be accessed at [www.onsemi.com/site/pdf/Patent-Marking.pdf](http://www.onsemi.com/site/pdf/Patent-Marking.pdf). ON Semiconductor reserves the right to make changes without further notice to any products herein. ON Semiconductor makes no warranty, representation or guarantee regarding the suitability of its products for any particular purpose, nor does ON Semiconductor assume any liability arising out of the application or use of any product or circuit, and specifically disclaims any and all liability, including without limitation special, consequential or incidental damages. Buyer is responsible for its products and applications using ON Semiconductor products, including compliance with all laws, regulations and safety requirements or standards, regardless of any support or applications information provided by ON Semiconductor. "Typical" parameters which may be provided in ON Semiconductor data sheets and/or specifications can and do vary in different applications and actual performance may vary over time. All operating parameters, including "Typicals" must be validated for each customer application by customer's technical experts. ON Semiconductor does not convey any license under its patent rights nor the rights of others. ON Semiconductor products are not designed, intended, or authorized for use as a critical component in life support systems or any FDA Class 3 medical devices or medical devices with a same or similar classification in a foreign jurisdiction or any devices intended for implantation in the human body. Should Buyer purchase or use ON Semiconductor products for any such unintended or unauthorized application, Buyer shall indemnify and hold ON Semiconductor and its officers, employees, subsidiaries, affiliates, and distributors harmless against all claims, costs, damages, and expenses, and reasonable attorney fees arising out of, directly or indirectly, any claim of personal injury or death associated with such unintended or unauthorized use, even if such claim alleges that ON Semiconductor was negligent regarding the design or manufacture of the part. ON Semiconductor is an Equal Opportunity/Affirmative Action Employer. This literature is subject to all applicable copyright laws and is not for resale in any manner.

## PUBLICATION ORDERING INFORMATION

### LITERATURE FULFILLMENT:

Email Requests to: [orderlit@onsemi.com](mailto:orderlit@onsemi.com)

ON Semiconductor Website: [www.onsemi.com](http://www.onsemi.com)

### TECHNICAL SUPPORT

North American Technical Support:  
Voice Mail: 1 800-282-9855 Toll Free USA/Canada  
Phone: 011 421 33 790 2910

Europe, Middle East and Africa Technical Support:

Phone: 00421 33 790 2910

For additional information, please contact your local Sales Representative