

C2012C0G2W471J060AA

TDK Item Description : C2012C0G2W471JT****



Application & Main Feature

Commercial Grade (Mid Voltage (100 to 630V))

Series

C2012 [EIA 0805]

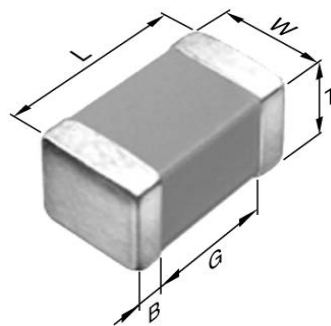

Dimensions

L	2.00mm ±0.20mm
W	1.25mm ±0.20mm
T	0.60mm ±0.15mm
B	0.20mm Min.
G	0.50mm Min.

Temperature Characteristic

C0G (-55 to 125 degC 0+/-30ppm/degC)

Rated Voltage

2W(450Vdc)

Capacitance

470pF

Capacitance Tolerance

J (±5%)

Q Factor

1000 Min.

Insulation Resistance

10Gohm Min

AEC-Q200

Not Applicable

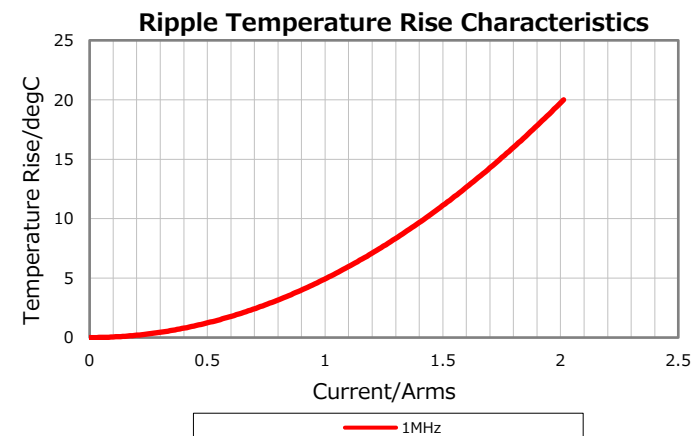
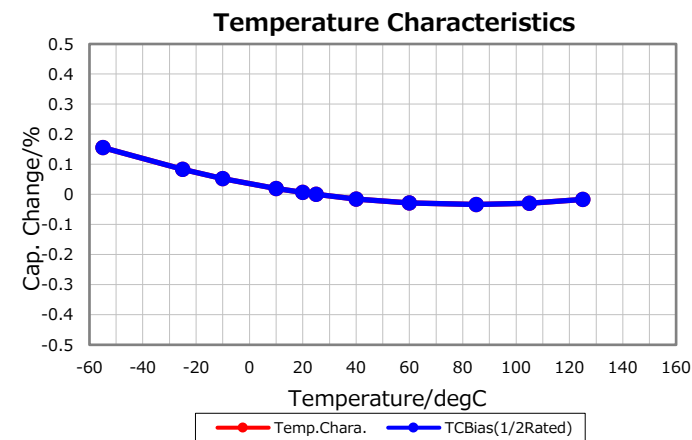
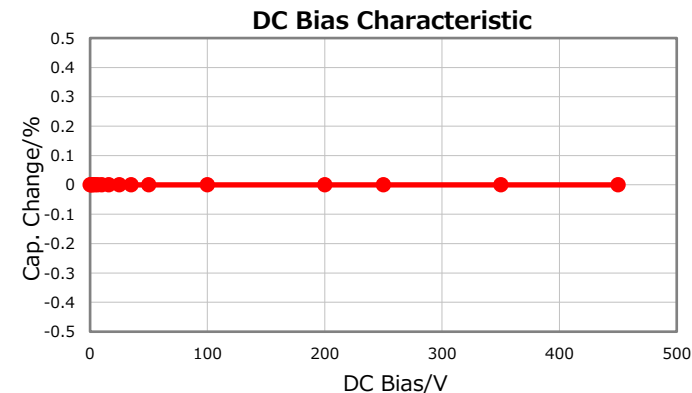
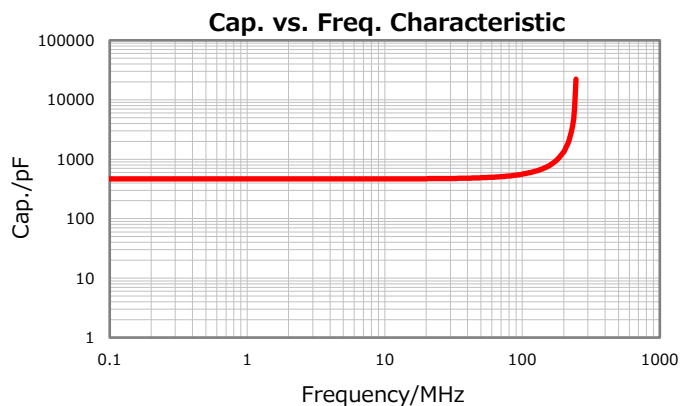
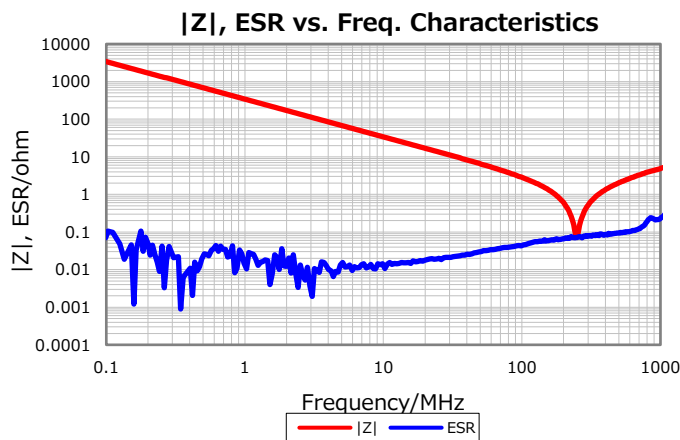

Characterization Sheet (Multilayer Ceramic Chip Capacitors)



All specifications are subject to change without notice.

July 2, 2019