

# TrenchHV™ Power MOSFET

IXTH96N25T  
IXTQ96N25T  
IXTV96N25T

N-Channel Enhancement Mode  
Avalanche Rated



$$V_{DSS} = 250V$$

$$I_{D25} = 96A$$

$$R_{DS(on)} \leq 29m\Omega$$

Symbol	Test Conditions	Maximum Ratings	
$V_{DSS}$	$T_J = 25^\circ C$ to $150^\circ C$	250	V
$V_{DGR}$	$T_J = 25^\circ C$ to $150^\circ C$ , $R_{GS} = 1M\Omega$	250	V
$V_{GSM}$	Transient	$\pm 30$	V
$I_{D25}$	$T_C = 25^\circ C$	96	A
$I_{LRMS}$	Lead Current Limit, RMS	75	A
$I_{DM}$	$T_C = 25^\circ C$ , pulse width limited by $T_{JM}$	250	A
$I_{AS}$	$T_C = 25^\circ C$	5	A
$E_{AS}$	$T_C = 25^\circ C$	2	J
$P_D$	$T_C = 25^\circ C$	625	W
$T_J$		-55 ... +150	$^\circ C$
$T_{JM}$		150	$^\circ C$
$T_{stg}$		-55 ... +150	$^\circ C$
$T_L$	1.6mm (0.062 in.) from case for 10s	300	$^\circ C$
$T_{SOLD}$	Plastic body for 10 seconds	260	$^\circ C$
$M_d$	Mounting torque (TO-247 & TO-3P)	1.13 / 10	Nm/lb.in.
$F_C$	Mounting force (PLUS220)	11..65 / 2.5..14.6	N/lb.
<b>Weight</b>	TO-247	6.0	g
	TO-3P	5.5	g
	PLUS220	4.0	g

TO-247 (IXTH)

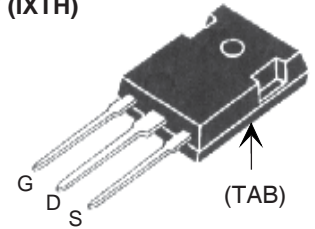

TO-3P (IXTQ)

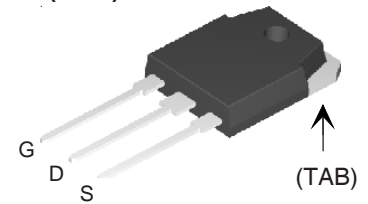

PLUS220 (IXTV)

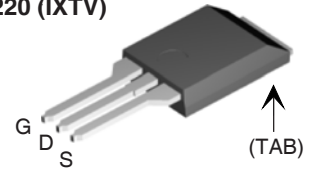

G = Gate      D = Drain  
S = Source      TAB = Drain

## Features

- International standard packages
- Avalanche rated
- Low package inductance
  - easy to drive and to protect

## Advantages

- Easy to mount
- Space savings
- High power density

## Applications

- DC-DC converters
- Battery chargers
- Switched-mode and resonant-mode power supplies
- DC choppers
- AC motor control
- Uninterruptible power supplies

Symbol	Test Conditions ( $T_J = 25^\circ C$ unless otherwise specified)	Characteristic Values		
		Min.	Typ.	Max.
$BV_{DSS}$	$V_{GS} = 0V$ , $I_D = 250\mu A$	250		V
$V_{GS(th)}$	$V_{DS} = V_{GS}$ , $I_D = 1mA$	3		5 V
$I_{GSS}$	$V_{GS} = \pm 20V$ , $V_{DS} = 0V$			$\pm 200$ nA
$I_{DSS}$	$V_{DS} = V_{DSS}$ $V_{GS} = 0V$ $T_J = 125^\circ C$			5 $\mu A$ 250 $\mu A$
$R_{DS(on)}$	$V_{GS} = 10V$ , $I_D = 0.5 \cdot I_{D25}$ , Notes 1, 2			29 m $\Omega$

Symbol	Test Conditions	Characteristic Values		
		Min.	Typ.	Max.
$(T_J = 25^\circ\text{C unless otherwise specified})$				
$g_{fs}$	$V_{DS} = 10\text{V}, I_D = 0.5 \cdot I_{D25}$ , Note 1	50	82	S
$C_{iss}$	$V_{GS} = 0\text{V}, V_{DS} = 25\text{V}, f = 1\text{MHz}$		6100	pF
$C_{oss}$		625	pF	
$C_{rss}$		75	pF	
$t_{d(on)}$	<b>Resistive Switching Times</b> $V_{GS} = 10\text{V}, V_{DS} = 0.5 \cdot V_{DSS}, I_D = 0.5 \cdot I_{D25}$ $R_G = 2.5\Omega$ (External)		20	ns
$t_r$		22	ns	
$t_{d(off)}$		59	ns	
$t_f$		28	ns	
$Q_{g(on)}$	$V_{GS} = 10\text{V}, V_{DS} = 0.5 \cdot V_{DSS}, I_D = 25\text{A}$		114	nC
$Q_{gs}$		33	nC	
$Q_{gd}$		34	nC	
$R_{thJC}$			0.20	$^\circ\text{C/W}$
$R_{thCS}$			0.25	$^\circ\text{C/W}$

### Source-Drain Diode

Symbol	Test Conditions	Characteristic Values			
		Min.	Typ.	Max.	
$T_J = 25^\circ\text{C unless otherwise specified}$					
$I_S$	$V_{GS} = 0\text{V}$			96	A
$I_{SM}$	Repetitive, pulse width limited by $T_{JM}$			300	A
$V_{SD}$	$I_F = I_S, V_{GS} = 0\text{V}$ , Note 1			1.5	V
$t_{rr}$	$I_F = 48\text{A}, -di/dt = 250\text{A}/\mu\text{s}$ $V_R = 100\text{V}, V_{GS} = 0\text{V}$		158		ns
$I_{RM}$			23		A
$Q_{RM}$			1.8		$\mu\text{C}$

- Notes: 1. Pulse test,  $t \leq 300\text{ms}$ ; duty cycle,  $d \leq 2\%$ .  
2. On through-hole packages,  $R_{DS(on)}$  Kelvin test contact location must be 5 mm or less from the package body.

### TO-247AD Outline

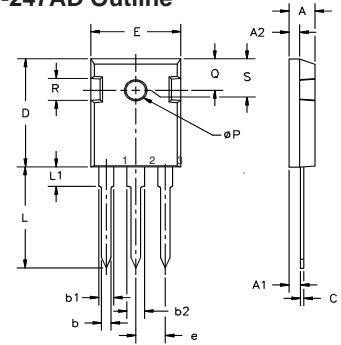

Terminals: 1 - Gate 2 - Drain  
3 - Source Tab - Drain

Dim.	Millimeter		Inches	
	Min.	Max.	Min.	Max.
A	4.7	5.3	.185	.209
A <sub>1</sub>	2.2	2.54	.087	.102
A <sub>2</sub>	2.2	2.6	.059	.098
b	1.0	1.4	.040	.055
b <sub>1</sub>	1.65	2.13	.065	.084
b <sub>2</sub>	2.87	3.12	.113	.123
C	.4	.8	.016	.031
D	20.80	21.46	.819	.845
E	15.75	16.26	.610	.640
e	5.20	5.72	0.205	0.225
L	19.81	20.32	.780	.800
L1		4.50		.177
ÆP	3.55	3.65	.140	.144
Q	5.89	6.40	0.232	0.252
R	4.32	5.49	.170	.216
S	6.15	BSC	242	BSC

### TO-3P (IXTQ) Outline

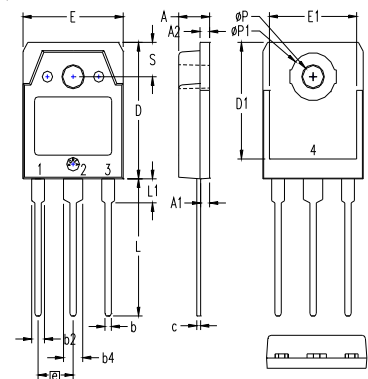

Pins: 1 - Gate 2 - Drain  
3 - Source 4, TAB - Drain

SYM	INCHES		MILLIMETERS	
	MIN	MAX	MIN	MAX
A	.185	.193	4.70	4.90
A1	.051	.059	1.30	1.50
A2	.057	.065	1.45	1.65
b	.035	.045	0.90	1.15
b2	.075	.087	1.90	2.20
b4	.114	.126	2.90	3.20
c	.022	.031	0.55	0.80
D	.780	.791	19.80	20.10
D1	.665	.677	16.90	17.20
E	.610	.622	15.50	15.80
E1	.531	.539	13.50	13.70
e	.215 BSC		5.45 BSC	
L	.779	.795	19.80	20.20
L1	.134	.142	3.40	3.60
ØP	.126	.134	3.20	3.40
ØP1	.272	.280	6.90	7.10
S	.193	.201	4.90	5.10

All metal area are tin plated.

### PLUS220 (IXTV) Outline

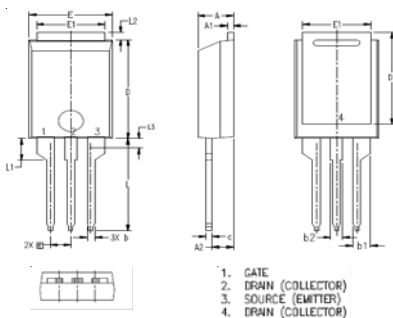

SYM	INCHES		MILLIMETER	
	MIN	MAX	MIN	MAX
A	.169	.185	4.30	4.70
A1	.028	.035	0.70	0.90
A2	.098	.118	2.50	3.00
b	.035	.047	0.90	1.20
b1	.080	.095	2.03	2.41
b2	.054	.064	1.37	1.63
c	.028	.035	0.70	0.90
D	.551	.591	14.00	15.00
D1	.512	.539	13.00	13.70
E	.394	.433	10.00	11.00
E1	.331	.345	8.40	8.80
e	.100 BSC		2.54 BSC	
L	.512	.551	13.00	14.00
L1	.118	.138	3.00	3.50
L2	.035	.051	0.90	1.30
L3	.047	.059	1.20	1.50

### PRELIMINARY TECHNICAL INFORMATION

The product presented herein is under development. The Technical Specifications offered are derived from data gathered during objective characterizations of preliminary engineering lots; but also may yet contain some information supplied during a pre-production design evaluation. IXYS reserves the right to change limits, test conditions, and dimensions without notice.

IXYS reserves the right to change limits, test conditions, and dimensions.

IXYS MOSFETs and IGBTs are covered by one or more of the following U.S. patents:	4,835,592	4,931,844	5,049,961	5,237,481	6,162,665	6,404,065 B1	6,683,344	6,727,585	7,005,734 B2	7,157,338 B2
	4,850,072	5,017,508	5,063,307	5,381,025	6,259,123 B1	6,534,343	6,710,405 B2	6,759,692	7,063,975 B2	
	4,881,106	5,034,796	5,187,117	5,486,715	6,306,728 B1	6,583,505	6,710,463	6,771,478 B2	7,071,537	

**Fig. 1. Output Characteristics  
@ 25°C**

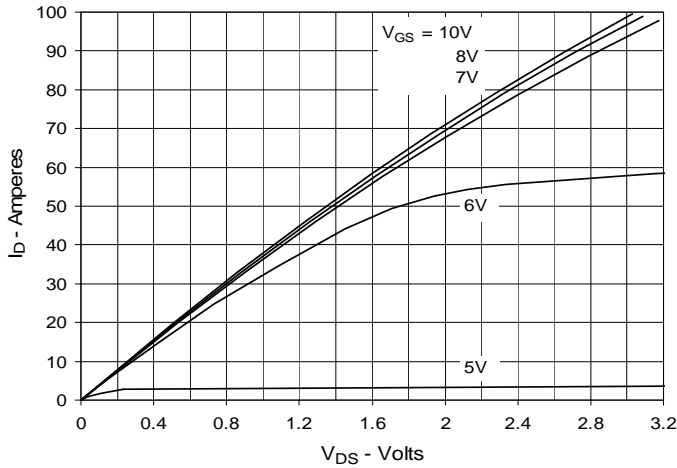

**Fig. 2. Extended Output Characteristics  
@ 25°C**

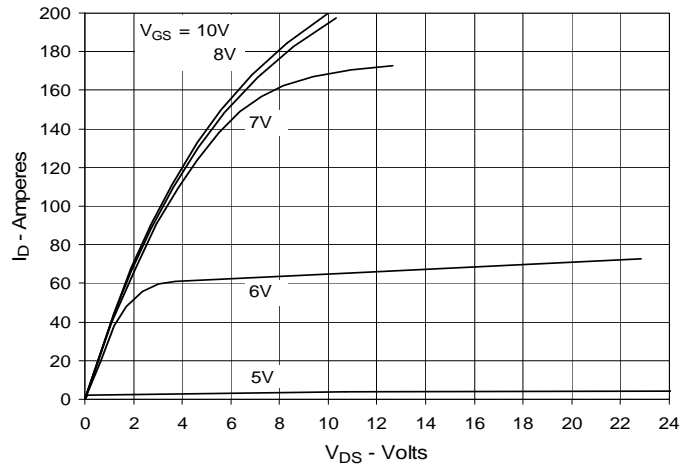

**Fig. 3. Output Characteristics  
@ 125°C**

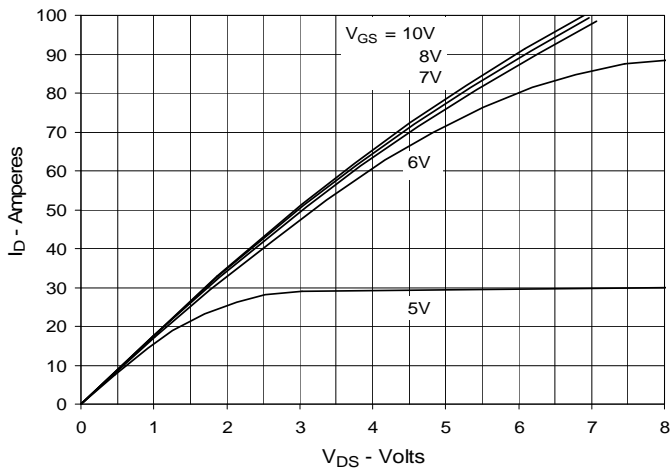

**Fig. 4.  $R_{DS(on)}$  Normalized to  $I_D = 48A$  Value  
vs. Junction Temperature**

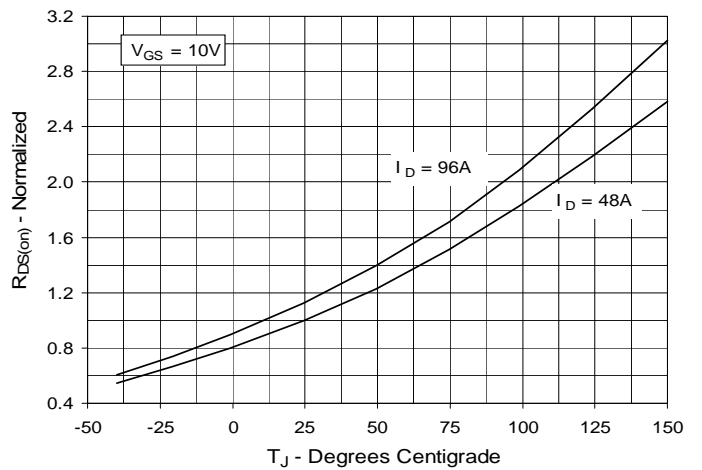

**Fig. 5.  $R_{DS(on)}$  Normalized to  $I_D = 48A$  Value  
vs. Drain Current**

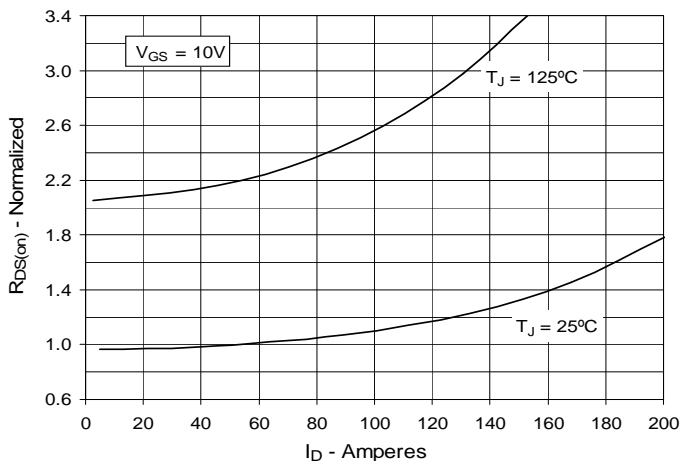

**Fig. 6. Maximum Drain Current vs.  
Case Temperature**

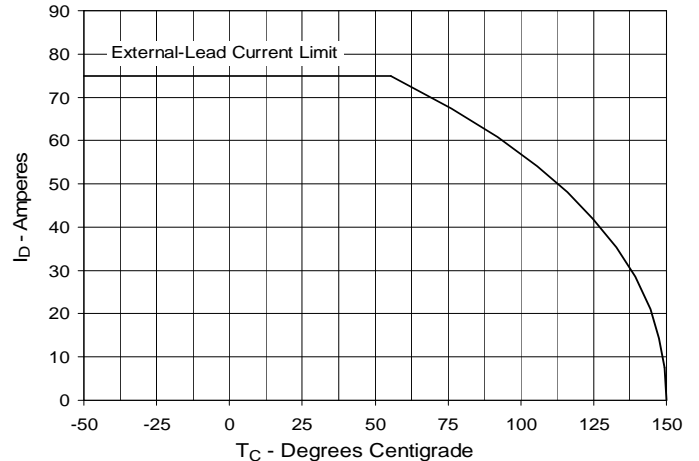

**Fig. 7. Input Admittance**

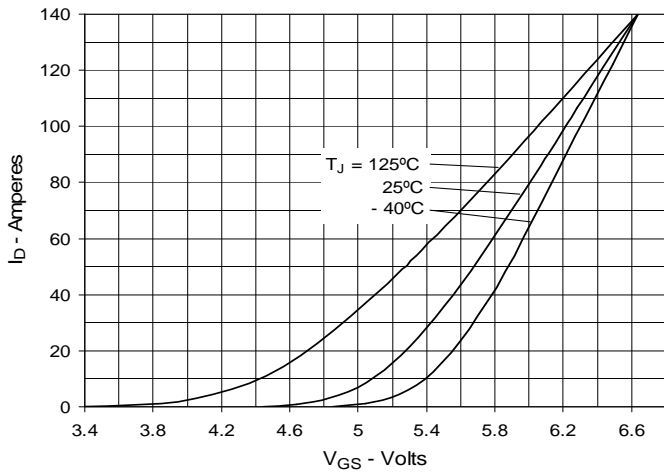

**Fig. 8. Transconductance**

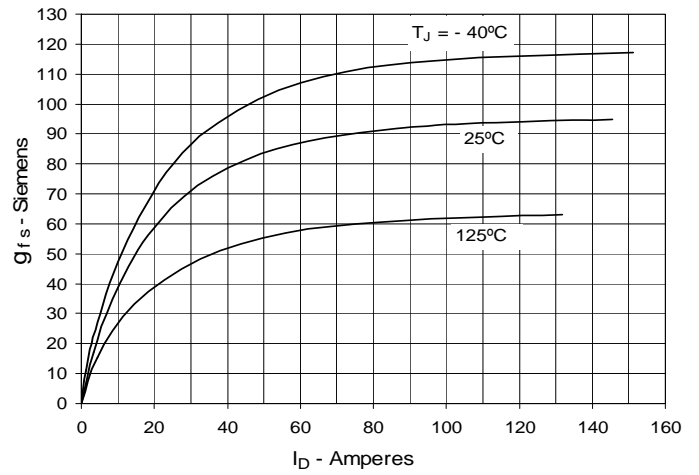

**Fig. 9. Forward Voltage Drop of Intrinsic Diode**

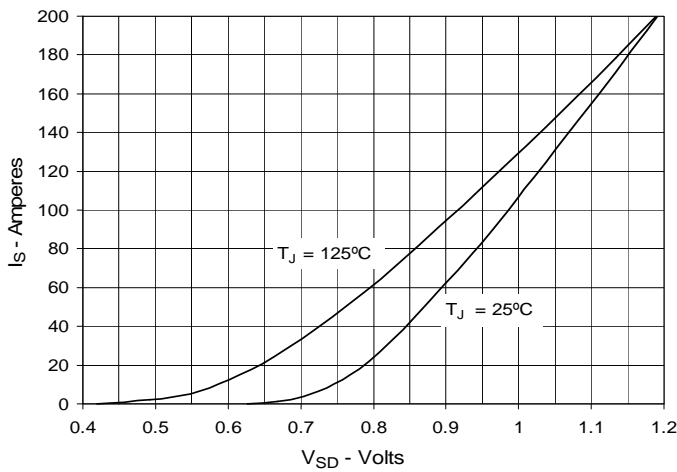

**Fig. 10. Gate Charge**

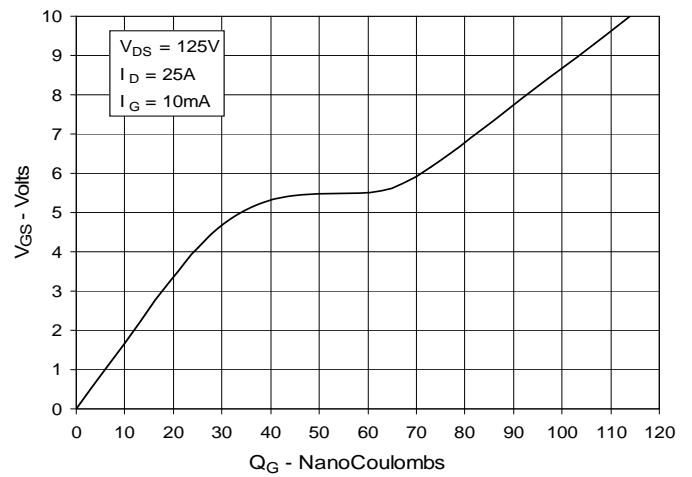

**Fig. 11. Capacitance**

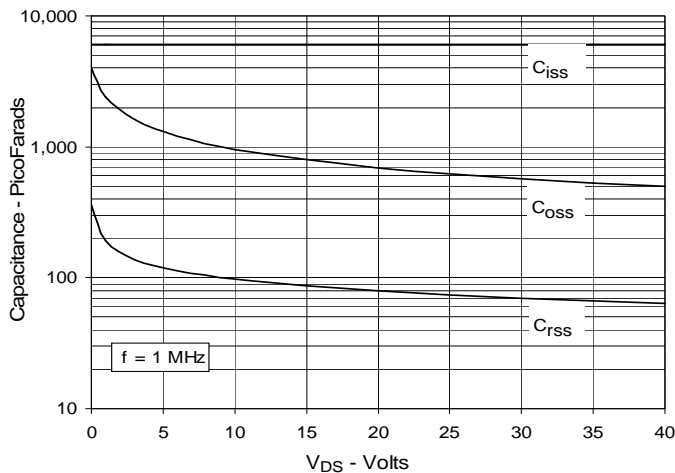

**Fig. 12. Maximum Transient Thermal Impedance**

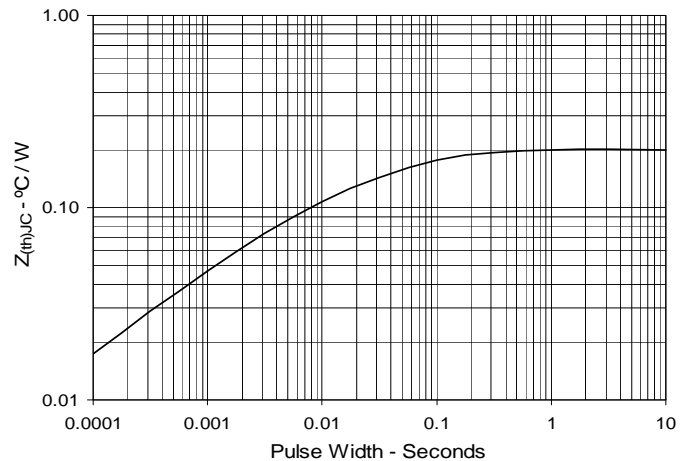

**Fig. 13. Resistive Turn-on Rise Time vs. Junction Temperature**

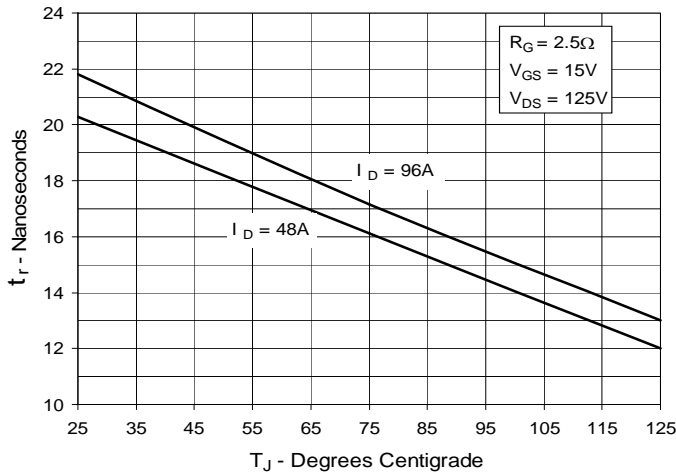

**Fig. 14. Resistive Turn-on Rise Time vs. Drain Current**

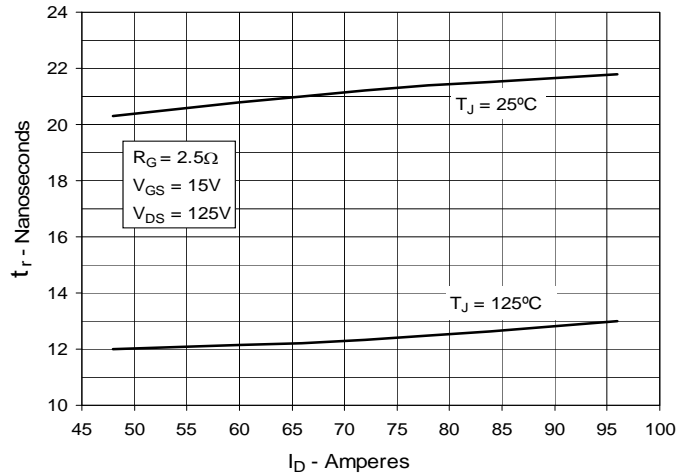

**Fig. 15. Resistive Turn-on Switching Times vs. Gate Resistance**

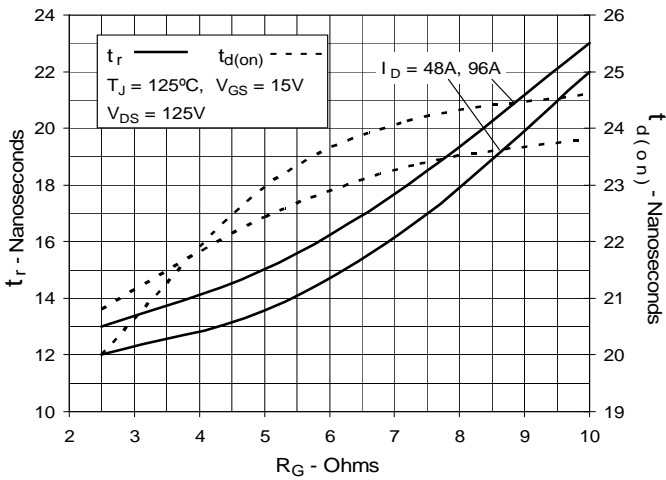

**Fig. 16. Resistive Turn-off Switching Times vs. Junction Temperature**

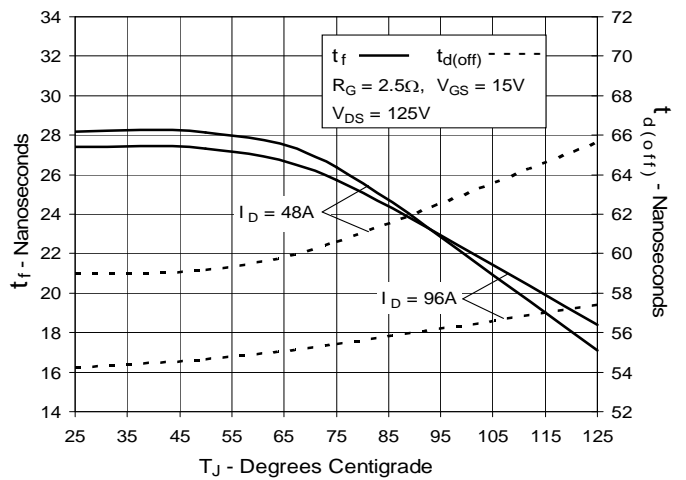

**Fig. 17. Resistive Turn-off Switching Times vs. Drain Current**

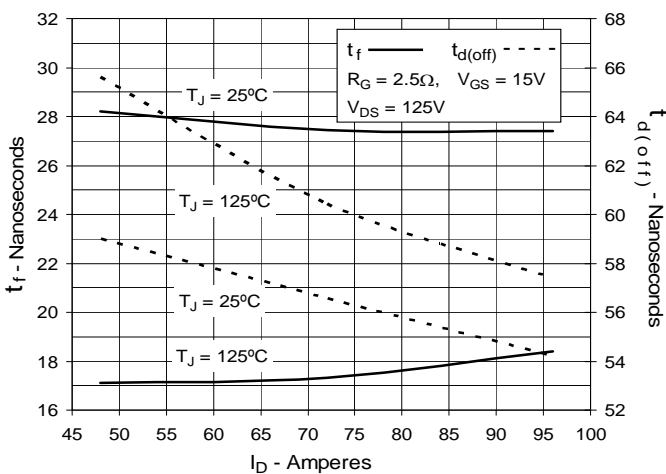

**Fig. 18. Resistive Turn-off Switching Times vs. Gate Resistance**

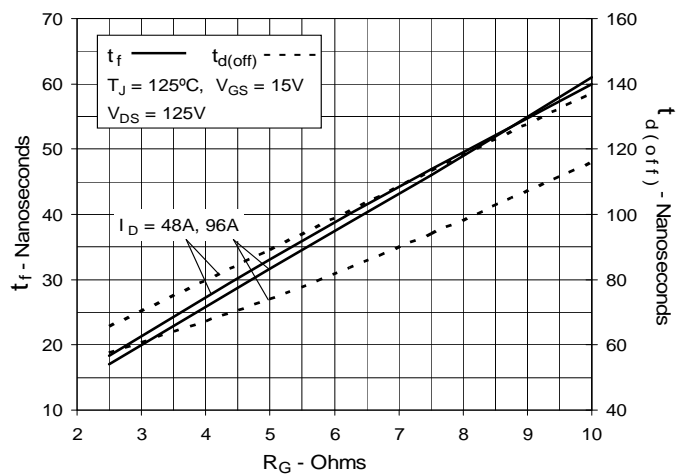



---

Disclaimer Notice - Information furnished is believed to be accurate and reliable. However, users should independently evaluate the suitability of and test each product selected for their own applications. Littelfuse products are not designed for, and may not be used in, all applications. Read complete Disclaimer Notice at [www.littelfuse.com/disclaimer-electronics](http://www.littelfuse.com/disclaimer-electronics).